

UNIVERSIDADE FEDERAL DO RIO GRANDE DO SUL
PROGRAMA DE PÓS-GRADUAÇÃO EM GENÉTICA E BIOLOGIA
MOLECULAR

**CÂNCER HEREDITÁRIO ASSOCIADO AOS GENES *TP53*, *BRCA1*
E *BRCA2*: ANÁLISES GENÔMICAS, FUNCIONAIS E CLÍNICAS**

GABRIEL DE SOUZA MACEDO

Tese submetida ao Programa de Pós-Graduação em Genética e Biologia Molecular da UFRGS como requisito parcial para a obtenção do grau de Doutor em Ciências (Genética e Biologia Molecular).

Orientadora: Prof^a Dr^a Patricia Ashton-Prolla

Porto Alegre, Junho de 2016.

Instituições e Fontes Financiadoras

Este trabalho foi realizado no Laboratório de Medicina Genômica do Serviço de Pesquisa Experimental do Hospital de Clínicas de Porto Alegre (HCPA) e no Laboratório de Patologia Molecular e Genômica Tumoral do *Memorial Sloan Kettering Cancer Center* em Nova York.

Laboratórios de apoio experimental:

Laboratório de Reparo de DNA (CEA, Grenoble, França)
Laboratório de Análise de Metabólitos (Serviço de Genética Médica, HCPA)
Laboratório de Bioquímica Celular (Departamento de Bioquímica, UFRGS)

Apoio financeiro:

Conselho Nacional de Desenvolvimento Científico e Tecnológico (CNPq)
Conselho de Aperfeiçoamento de Pessoal de Nível Superior (CAPES)
Fundo de Incentivo à Pesquisa e Eventos do Hospital de Clínicas de Porto Alegre

Vó, a ti dedico esta conquista. Por todo amor e carinho que me foi dedicado. Mãe e pai, vocês foram fundamentais para que eu seguisse sempre com foco, determinação e humildade minha trajetória. Muito obrigado sempre!

Agradecimentos

Profa. Patricia Ashton Prolla, por simplesmente ter sido a orientadora, conselheira e amiga que foi. Agradeço pelas inúmeras oportunidades, pela incansável ajuda durante todas as etapas da minha carreira científica e por seu otimismo constante. É um orgulho e uma felicidade conviver e aprender diariamente contigo.

A busca por voos mais altos me levou até o laboratório do Dr. Jorge Reis-Filho no *Memorial Sloan Kettering Cancer Center* em Nova Iorque. Agradeço o Dr. Jorge pela oportunidade, conselhos e pela possibilidade de participar de inúmeros projetos em um curto espaço de tempo. Agradeço também a Dra. Britta Weigelt por todo o suporte e paciência.

Igor Araújo, por ter sido meu iniciação científica e “braço direito”. Obrigado por tua dedicação, profissionalismo e responsabilidade.

Colegas e amigos do MSKCC, em especial a Letícia Arruda, Anastasios Papanastasiou, Felipe Geyer, Maria do Rosário, Anne Schultheis, Kathellen Burke, Wen Huei-Chi, Luciano Martelotto e Salvatore Piscuoglio.

Dra. Sylvie Sauvaigo, pela maneira com que me acolheu em Grenoble e por ter aberto as portas de seu laboratório para a realização dos experimentos de reparo de DNA. Agradeço também ao Sylvain Caillat, pela amizade e auxílio nas análises laboratoriais.

Prof. Fabio Klamt, por toda ajuda nos experimentos relacionados a bionergética. Obrigado pelo empenho, presteza e, principalmente, por tua motivação. Agradeço também à Ivi Bristot pela ajuda no planejamento, execução e análise dos dados.

Profa. Carmen Regla Vargas, pela colaboração desde meu mestrado e por estar sempre disposta a ajudar. Agradeço também a Caroline Mescka por auxiliar nos experimentos de estresse oxidativo.

Dra. Vanusa Manfredini, pelo auxílio nas dosagens de MDA e Vitamina C.

Os médicos Cristina Netto, Filippo Vairo e Camila Bittar, pela auxílio nos atendimentos dos pacientes recrutados para o estudo clínico.

Dra. Maria Isabel Achatz e Dra. Edenir Inez Palmero, pela colaboração nos estudos genéticos apresentados nesta tese.

Colegas e ex-colegas do Laboratório de Medicina Genômica do CPE-HCPA, por todos estes anos de convivência. Um agradecimento especial as colegas, amigas e colaboradoras Fernanda Salles Vianna, Bárbara Alemar, Juliana Giacomazzi e Ana Paula Brandalize.

Elmo (PPGBM) e Everaldo (HCPA), pela presteza e auxílio em questões burocráticas.

Meus queridos amigos Henrique, Gustavo, Kel, Renan, Juliana, Bárbara, Inácio e Isabel. Obrigado pelo companheirismo de tantos anos, confiança e por me mostrarem o real valor de uma amizade .

Meus pais, Gabriel Macedo e Silvana Moreira, por serem meus exemplos e meus maiores incentivadores. Obrigada pela amizade, estímulo constante, confiança e por investirem em mim mesmo quando as coisas não eram nada fáceis.

Minha avó Dinah, por estar sempre presente, por ser meu amparo, por ser a voz que me acalmou e incentivou naqueles momentos em que precisei. Sou eternamente grato por ser teu neto/filho.

LISTA DE ABREVIATURAS E SIGLAS	7
RESUMO	9
ABSTRACT	11
CAPÍTULO I. INTRODUÇÃO	13
1. PREDISPOSIÇÃO HEREDITÁRIA AO CÂNCER.....	13
1.2 GENE <i>TP53</i>	15
1.2.1 Síndrome de Li-Fraumeni.....	15
1.2.2 Mutações no gene <i>TP53</i>	17
1.2.3 A mutação germinativa <i>TP53 R337H</i> no Brasil.....	19
1.2.4 <i>p53</i> : estrutura e função.....	23
<i>p53</i> na regulação do metabolismo energético e oxidativo.....	25
<i>p53</i> na resposta a dano de DNA.....	27
1.2.5 <i>p53</i> mutante e seus efeitos biológicos.....	29
1.2.6 Impacto de mutações na Síndrome Li-Fraumeni.....	30
1.3 GENES <i>BRCA1</i> E <i>BRCA2</i>	33
1.3.1 Epidemiologia do câncer de mama.....	33
1.3.2 Câncer de mama hereditário associado a mutações em <i>BRCA1</i> e <i>BRCA2</i>	34
1.3.3 <i>BRCA1</i> e <i>BRCA2</i> : estrutura e função.....	36
1.3.4 O conceito de letalidade sintética entre <i>BRCA</i> e <i>PARP1</i>	37
1.3.4 Imunofenótipo e genômica do CM associado a mutações em <i>BRCA1/2</i>	39
CAPÍTULO II. JUSTIFICATIVA E OBJETIVOS	42
CAPÍTULO III. RARE GERMLINE VARIANT (RS78378222) IN THE <i>TP53</i> 3' UTR: EVIDENCE FOR A NEW MECHANISM OF CANCER PREDISPOSITION IN LI-FRAUMENI SYNDROME.	46
CAPÍTULO IV. <i>P53</i> SIGNALING PATHWAY POLYMORPHISMS, CANCER RISK AND TUMOR PHENOTYPE IN <i>TP53 R337H</i> MUTATION CARRIERS.	57
CAPÍTULO V. INCREASED REDOX METABOLISM AND PERTURBED DNA DAMAGE RESPONSES IN PRIMARY FIBROBLASTS FROM LI-FRAUMENI SYNDROME PATIENTS.	72
CAPÍTULO VI. INFLAMAÇÃO E EFEITO DE SUBSTÂNCIAS ANTIOXIDANTES SOBRE O FENÓTIPO BIOQUÍMICO DE ESTRESSE OXIDATIVO EM PORTADORES DA MUTAÇÃO R337H.	95
CAPÍTULO VII. PATHOLOGY OF <i>BRCA1/2</i> AND <i>PALB2</i> RELATED CANCER.	103
CAPÍTULO IX. THE LANDSCAPE OF SOMATIC GENETIC ALTERATIONS IN <i>BRCA1</i> AND <i>BRCA2</i> BREAST CANCERS.	144
DISCUSSÃO	168
REFERÊNCIAS BIBLIOGRÁFICAS	178
ANEXOS	188

ALDH4A1 - Aldeído desidrogenase 4, membro 1
AMPK - Proteína quinase ativada por AMP
ATM - Proteína mutada na Ataxia Telangiectasia
ATR - Proteína relacionada a Rad3 e Ataxia Telangiectasia
BAX - Proteína X associada a Bcl-2
BCL2 - proteína 2 de Linfoma de células B
BRCA1 - *BReast CAncer type 1 susceptibility protein*
BRCA2 - *BReast CAncer type 2 susceptibility protein*
CAC - Carcinoma Adrenocortical
CAPES - Conselho de Aperfeiçoamento de Pessoal de Nível Superior
CHEK2 - *Checkpoint Kinase 2*
CM - Câncer de mama
CNPq- Conselho Nacional de Desenvolvimento Científico e Tecnológico
DLD - Domínio de ligação ao DNA
ERO - Espécies Reativas de Oxigênio
EUA - Estados Unidos da América
FDA - *Food and Drug Administration*
GLUT1 - Transportador de glicose 1
Gpx1 - Glutathione Peroxidase 1
HBOC - *Hereditary Breast and Ovarian Cancer*
HCPA – Hospital de Clínicas de Porto Alegre
HER2 - Receptor 2 do fator de crescimento epidermal
HPV - Papilomavírus humano
IARC - *International Agency for Research on Cancer*
INCa - Instituto Nacional do Câncer
LFL - Síndrome de Li-Fraumeni-like
Mdm2 - *Mouse Double Minute 2*
MTOR - *Mechanistic Target Of Rapamycin*
p21 - Inibidor de quinase dependente de ciclina 1A
PALB2 - *Partner And Localizer of BRCA2*

PARP- *Poly (ADP-ribose) polymerase*
PRR - Região rica em prolinas
PTEN - *Phosphatase and TENsin Homolog*
PUMA - *P53 Up-Regulated Modulator Of Apoptosis*
RB1 - Retinoblastoma 1
RE - Receptor de estrógeno
RH - Recombinação Homóloga
RI - Radiação Ionizante
RP - Receptor de progesterona
SESN1 - Sestrina 1
SLF - Síndrome de Li-Fraumeni
SOD2 - Superóxido dismutase 2
SV40 - Vírus símio 40
TDA1 - Domínio de transativação 1
TDA2 - Domínio de transativação 2
TP53 - proteína tumoral p53
TSC2 - Esclerose Tuberosa 2

Aspectos genômicos, funcionais e clínicos de síndromes de predisposição hereditária ao câncer associadas aos genes *TP53*, *BRCA1* e *BRCA2* foram abordados nesta tese. No contexto do gene *TP53*, em que mutações germinativas causam Síndrome de Li-Fraumeni (SLF), nosso objetivo principal foi estudar as consequências funcionais e clínicas de algumas mutações encontradas em famílias brasileiras, especialmente a mutação fundadora R337H. Nossos resultados demonstram que células normais (fibroblastos) de indivíduos portadores de mutações em *TP53* caracterizam-se por alterações redox, com altos níveis de espécies reativas de oxigênio (ERO) associados a um processo persistente de reparo de DNA, provavelmente devido a um aumento do dano oxidativo. Também foi observada alta atividade no reparo de sítios apurínicos e apirimidínicos (sítios abásicos), um tipo de dano de DNA causado, principalmente, por ERO. Devido a bem estabelecida relação entre estresse oxidativo e inflamação, 28 marcadores inflamatórios, incluindo citocinas, quimiocinas e fatores de crescimento, foram dosados em plasma de indivíduos portadores da mutação R337H e controles. Um aumento significativo na dosagem de IL-12, bem como uma tendência de maiores níveis de IL-8, IL-17 e IFN- γ foram encontrados no grupo R337H, sugerindo atividade inflamatória. A fim de verificar o impacto de substâncias antioxidantes sobre o fenótipo bioquímico de estresse oxidativo, indivíduos portadores da mutação R337H e controles foram suplementados com N-acetilcisteína, Idebenona e Coenzima Q10, e parâmetros oxidativos foram avaliados antes e após o período de suplementação (14 dias). Nossos resultados apontam para um efeito da Coenzima Q10 e Idebenona na correção bioquímica de estresse oxidativo, visto que a suplementação com ambas substâncias foi capaz de diminuir os níveis de lipoperoxidação lipídica. Além dos estudos funcionais e clínicos acerca da mutação R337H, análises moleculares relacionadas ao papel de genes modificadores de fenótipo e de uma nova variante associada a SLF foram realizadas. Observamos que 7/129 (5.4%) indivíduos com fenótipo clínico de SLF/LFL e negativos para mutações em regiões codificantes de *TP53* são portadores de uma nova variante germinativa rara, rs78378222[C]. Achados adicionais relacionados a conservação evolutiva e impacto funcional desta

variante, tanto em fibroblastos quanto em tumores, confirmam sua patogenicidade e apontam para um mecanismo de haploinsuficiência de p53. Além disso, também foi observado a contribuição de um polimorfismo na região promotora do gene *MDM2* (SNP309) na idade do primeiro diagnóstico de câncer em portadores da mutação R337H. Já em relação ao conjunto de resultados relacionados à *BRCA1* e *BRCA2* apresentados nesta tese, 39 tumores de mama de pacientes com mutações germinativas nos genes *BRCA1* (n=29) e *BRCA2* (n=10) foram sequenciados no intuito de identificar o perfil de variação no número de cópias de DNA e mutações somáticas. A partir do sequenciamento massivo e paralelo foi possível concluir que a grande maioria destes tumores apresenta perda do alelo selvagem de *BRCA1* ou *BRCA2*, sendo que este parece ser um evento inicial na carcinogênese da maioria destas neoplasias. Além disso, mutações clonais em *TP53* foram observadas em uma parcela significativa dos casos, sendo estas, provavelmente, anteriores a perda do alelo selvagem de *BRCA1/2*. A identificação de tumores que preservam o alelo selvagem de *BRCA1* ou *BRCA2*, ou ainda que perdem este de maneira subclonal, levanta questões sobre o impacto de novas drogas que apresentam como alvo terapêutico os mecanismos de recombinação homóloga.

In this work, we aimed to study genomic, functional and clinical aspects of cancer predisposition syndromes associated to germline mutations in the *TP53*, *BRCA1* and *BRCA2* genes. With regard to *TP53*, in which germline mutations are associated to Li-Fraumeni syndrome (LFS), we were mainly interested in understanding the clinical and biological consequences of *TP53* germline mutations found in Brazilian families, with special attention to R337H mutation. Our results show that normal cells (fibroblasts) from LFS subjects have an hyperoxic phenotype characterized by high reactive oxygen species (ROS) levels, associated to a tendency for slower DNA repair and more persistent DNA damage. Interestingly, all mutant p53 fibroblasts showed higher repair activity of apurinic/pyrimidinic (AP) sites, a DNA lesion caused mainly by intensive ROS exposure. Given the well-described relationship between oxidative stress and inflammation, we then simultaneously quantified 25 cytokines, chemokines and growth factors in plasma of R337H mutation carriers and controls. We found significant higher levels of IL-12, as well as a tendency for increased IL-8, IL-17 and IFN- γ , in mutation carriers when compared to controls, suggesting inflammatory activation. In order to verify the impact of antioxidants on oxidative stress, we supplemented R337H mutation carriers and controls with N-acetylcysteine, Idebenone and Coenzyme-Q10 and oxidative parameters were measured before and after supplementation period (14 days). Our findings highlight to a benefit of supplementation with Coenzyme Q10 and Idebenone, since that both were able to decrease lipid peroxidation in R337H mutation carriers group. In addition to functional e clinical studies presented here, we also aimed to study the impact of genetic modifiers on clinical manifestation of R337H carriers as well as the contribution of a new rare *TP53* germline variant in LFS. In this context, we observed that 7 out of 129 (5.4%) subjects with clinical phenotype without *TP53* germline mutations in the *TP53* coding regions were carriers of a new functional variant, the rs78378222[C]. Further results related to the evolutionary conservation and functional impact of rs78378222[C] in both fibroblasts and in tumors confirm the pathogenicity of this variant and suggest a mechanism of haploinsufficiency. Finally, polymorphism analysis revealed an impact of the

MDM2 SNP309 on age at first tumor in R337H mutation carriers. Regarding *BRCA1* and *BRCA2*, we sequenced 39 breast tumors from patients carrying *BRCA1* (n=29) and *BRCA2* (n=10) germline mutations in order to determine the repertoire of copy number alterations and somatic mutations of these tumors. By using ultra-deep sequencing of bulk-tumor and normal tissue, we observed that most of these tumors were characterized by somatic inactivation of *BRCA1* and *BRCA2* wild-type allele, which were likely to be an early genetic event in carcinogenesis. Moreover, *TP53* somatic mutations were highly recurrent and all clonal, and we concluded that they likely precede *BRCA1* or *BRCA2* inactivation, as the latter was subclonal in some cases. The identification of tumors that preserved the *BRCA1* or *BRCA2* wild-type allele at all, or in which loss of the wild-type allele was restricted to subpopulations of cancers cells, raises concerns regarding response to drugs targeting homologous recombination deficiency in these tumors.

1. Predisposição hereditária ao câncer

A carcinogênese é definida como o processo pelo qual células normais transformam-se em células neoplásicas. Este processo decorre da aquisição de múltiplas alterações genéticas e epigenéticas em genes reguladores de processos biológicos, tais como ciclo celular, senescência, apoptose, sobrevivência, diferenciação, angiogênese, motilidade e metabolismo (Hanahan and Weinberg, 2011). Apesar do número exato de alterações moleculares necessárias para os processos de iniciação e progressão de tumores variarem entre indivíduos e, também, de acordo com o tipo de neoplasia, estudos genômicos recentes demonstraram que o número médio de mutações é relativamente pequeno, com a presença de 2-6 eventos mutacionais ocorrendo na maioria dos cânceres (Kandoth et al., 2013).

A maioria dos tumores em humanos é de etiologia multifatorial, surgindo como resultado de interações complexas entre genes e ambiente. No entanto, uma pequena parcela dos diagnósticos, mas não menos importante, está associada a uma predisposição herdada devido a alterações em genes de predisposição a câncer de alta penetrância (Hodgson, 2008). Estima-se que para a maior parte dos tumores malignos conhecidos, 5 a 10% seja de etiologia hereditária. Além disso, 20-30% dos casos correspondem a agrupamentos de tumores que ocorrem em uma mesma família, também conhecidos como tumores familiares. Apesar dos fatores etiológicos destes casos serem de difícil identificação, acredita-se que mutações em genes de baixa penetrância e exposição a fatores de risco ambientais expliquem esta parcela de casos (Lindor et al., 2008).

Genes de predisposição ao câncer são aqueles que, na presença de mutações germinativas, conferem alto ou moderado risco de desenvolvimento de tumores. No caso da predisposição hereditária ao câncer de mama, dentre os mais conhecidos e estudados estão *TP53*, *BRCA1*, *BRCA2*, *CHEK2* e *PALB2* (**Figura 1**). Atualmente, mais de 100 genes associados a mais de 50 diferentes síndromes de predisposição ao câncer já foram identificados (Rahman et al.,

2007). A maioria destas síndromes está associada a mutações de perda de função em genes supressores tumorais e apresenta herança autossômica dominante, o que confere um risco de 50% aos familiares de primeiro grau de um indivíduo portador de mutação, de também ser portador (Tucker and Friedman, 2002).

No ano de 1971, a partir do uso modelos matemáticos, o geneticista Alfred Knudson estudou uma série de casos de retinoblastoma, um tumor da retina que acomete principalmente crianças. Sua hipótese, conhecida como hipótese dos dois eventos mutacionais (do inglês, *two-hit model*), sugeria que ambos os alelos de um gene supressor de tumor precisariam ser inativados para a ocorrência do retinoblastoma (Knudson, 1971). Mais de 10 anos depois, o gene *RB1* foi descoberto como sendo a causa deste tipo de tumor e a hipótese dos dois eventos foi confirmada experimentalmente (Fung et al., 1987). Hoje, o modelo de Knudson é ainda utilizado para explicar o surgimento de tumores na grande maioria das síndromes de predisposição ao câncer associadas a mutações germinativas em genes supressores de tumor. Neste modelo, os dois eventos podem ser somáticos nas formas não hereditárias ou então, o primeiro evento pode ser uma mutação herdada (germinativa) e o segundo evento uma mutação somática nas formas hereditárias da doença.

Algumas características fenotípicas específicas presentes em um único indivíduo e/ou família são ferramentas úteis para a identificação de indivíduos com alta probabilidade de mutações em genes de predisposição ao câncer. Dentre estas características estão: (1) história familiar incluindo vários casos de um mesmo tipo de câncer e/ou vários casos de diversos (e relacionados) tipos de câncer na família; (2) diagnóstico de câncer em idade jovem; (3) ocorrência de múltiplos tumores primários em um mesmo indivíduo; (4) presença de multifocalidade ou bilateralidade do tumor; (5) tumores com histologia rara, entre outras (Alpert and Haffty, 2004; Hartmann et al., 1999; Narod and Offit, 2005; Rebbeck et al., 2002).



Figura 1. Genética do risco de câncer. Esta figura mostra os diferentes tipos de variantes genéticas, de acordo com a frequência alélica populacional e tamanho do efeito (penetrância). Também são mostrados alguns exemplos de genes associados a Síndromes de Predisposição Hereditária ao câncer (adaptado de Manolio et al., 2009).

1.2 Gene *TP53*

1.2.1 Síndrome de Li-Fraumeni

No ano de 1969, a partir da análise de centenas de prontuários médicos e atestados de óbito de crianças norte-americanas diagnosticadas com rabdomyossarcoma, uma neoplasia maligna da musculatura esquelética, Frederick Pei Li e Joseph F. Fraumeni Junior, ambos médicos norte-americanos, observaram que 4 famílias apresentavam um padrão de alta ocorrência de sarcomas na infância e câncer de mama (CM) em idade jovem (Li and Fraumeni, 1969a). A observação destas famílias com agrupamentos de tumores pouco frequentes e com idades ao diagnóstico relativamente mais precoces do que o observado na população geral, fez com que Li e Fraumeni propusessem uma nova síndrome de predisposição hereditária ao câncer - a Síndrome de Li-Fraumeni (SLF) (LFS, OMIM# 151623) (Li and Fraumeni, 1969b).

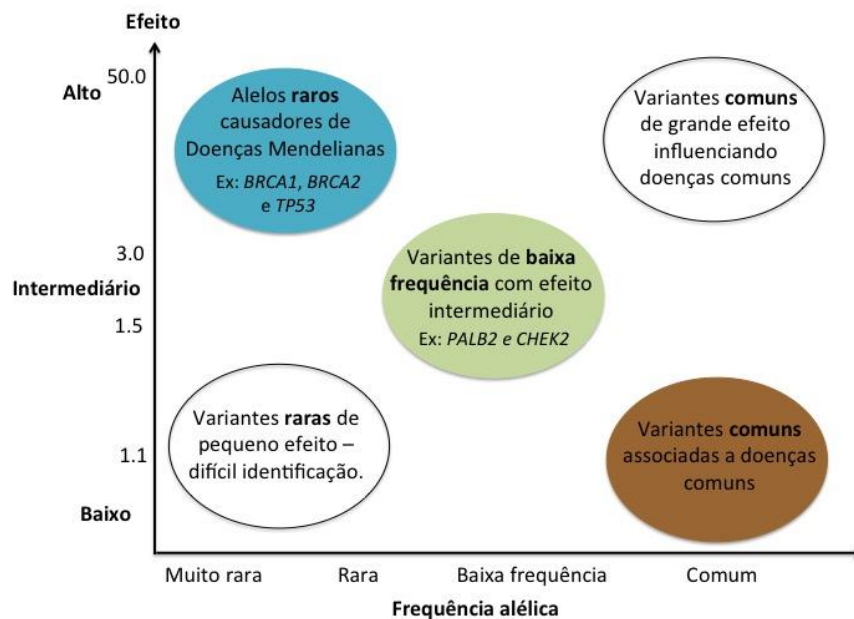
A definição inicial do espectro de tumores da SLF foi realizada a partir de critérios específicos, também chamados de critérios clássicos. Baseado na história familiar dos indivíduos, estes critérios incluem: um indivíduo diagnosticado com sarcoma em idade jovem e dois familiares de primeiro e/ou segundo grau diagnosticados com osteossarcomas, sarcomas de partes moles, CM em mulheres na pré-menopausa, tumores de sistema nervoso central, carcinoma adrenocortical (CAC) ou leucemias agudas. Desta forma, a SLF foi caracterizada, inicialmente, pela concentração familiar de sarcomas de partes moles, sarcomas ósseos, tumores de sistema nervoso central, CAC e CM. Estes foram descritos como os tumores centrais da SLF, também denominados “*core tumors*” do fenótipo (Li and Fraumeni, 1982; Malkin et al., 1990).

Posteriormente, outros estudos encontraram famílias com tumores além daqueles inicialmente descritos, tais como melanoma, carcinoma bronquioloalveolar de pulmão, câncer gástrico e de próstata, tumores de células germinativas e tumor de Wilms (Frebourg et al., 2001; Hartley et al., 1989; Masciari et al., 2011). Estas neoplasias estão incluídas nas formas variantes da síndrome, coletivamente denominadas de Síndrome de Li-Fraumeni-Like (LFL). Em decorrência destes achados, alguns outros critérios menos restritivos como os de Birch, Chompret e Eeles foram propostos para indicar a investigação da SLF e LFL (Birch, 1994; Eeles, 1995; Frebourg et al., 2001). Atualmente, na maioria dos países os critérios de Chompret são utilizados na indicação da realização do teste genético para diagnóstico molecular da síndrome.

Apesar do mecanismo molecular associado com a SLF e LFL não ter sido identificado até o final da década de 80, análises de segregação indicavam que a doença tinha uma etiologia genética (Willians and Strong, 1987). Mutações inativadoras no gene *TP53* já haviam sido encontradas em osteossarcomas esporádicos, sarcomas de partes moles, leucemias e carcinomas de mama, todos estes tumores presentes na SLF e LFL (Nigro et al., 1989a). Além disso, camundongos transgênicos com *p53* mutado também apresentavam incidência aumentada para os mesmos tumores citados anteriormente (Lavigne et al., 1989). A partir destes achados, no ano de 1990 o sequenciamento gênico de *TP53* em indivíduos com o fenótipo clínico de SLF permitiu a identificação de

mutações nos éxons 5-8 do gene, mostrando assim que mutações germinativas em *TP53* estavam associadas à predisposição ao câncer em uma significativa proporção das famílias com os critérios clínicos para SLF (Malkin et al., 1990).

O conhecimento adquirido nestas quase cinco décadas de estudos levou a inúmeros avanços no entendimento da doença. Estudos investigando a penetrância de câncer, por exemplo, demonstraram que portadores de uma mutação germinativa no gene *TP53* apresentam, em média, 50% de chance de desenvolver câncer antes dos 40 anos de idade, comparado com 1% da população geral da mesma faixa etária. Além disso, 90% dos portadores de mutações são diagnosticados com pelo menos um câncer até os 60 anos de idade (Birch et al., 1998). Estudos de correlação genótipo-fenótipo também demonstraram que o grau da perda de função de algumas mutações está associado a idade de diagnóstico de alguns tumores. Estes resultados têm impacto importante no manejo de pacientes portadores de mutações em *TP53* (Petitjean et al., 2007).

Atualmente, o diagnóstico molecular da SLF/LFL, realizado através da análise molecular do gene *TP53*, é indicado para pacientes que preencham os critérios clínicos de diagnóstico, especialmente o clássico e o de Chompret (Olivier et al., 2002). Embora critérios menos estritos, como os de Eeles possam ser utilizados, a probabilidade de se identificar uma mutação germinativa é maior em indivíduos com critérios mais estritos e menor em famílias com critérios mais abrangentes e menos rigorosos.

1.2.2 Mutações no gene *TP53*

Alterações somáticas em *TP53* ocorrem em praticamente todos os tipos de câncer. Em melanomas metastáticos, leucemias e tumores do colo de útero, mutações somáticas em *TP53* ocorrem em apenas 5% dos casos, ao contrário do que ocorre em tumores de ovário, câncer colorretal e esôfago, em que a frequência de mutações chega a 50% ou mais (Olivier et al., 2010; Petitjean et al., 2007). Apesar da baixa frequência de mutações encontradas no câncer do colo do útero associado ao vírus do HPV, por exemplo, hoje sabe-se que uma proteína

codificada pelo próprio vírus, a proteína E6, interage diretamente com p53, inativando-a. Assim, o vírus HPV não impõe pressão seletiva para a perda de p53 por mutações, mas sim, por um mecanismo diferente (Thomas et al., 1999). Estes achados sugerem que a inativação de p53 durante a carcinogênese é uma condição necessária para a ocorrência de uma grande parcela dos tumores humanos.

Ao contrário da maioria dos genes supressores tumorais envolvidos em síndromes hereditárias de predisposição ao câncer, que são inativados principalmente por pequenas ou grandes deleções e mutações de perda de sentido, mutações inativadoras no gene *TP53* são prioritariamente do tipo sentido trocado (do inglês, *missense*). Esse tipo de mutação permite a produção de uma proteína completa, estável e com a aquisição de propriedades oncogênicas (Hainaut and Hollstein, 2000).

Aproximadamente 86% das mutações no gene *TP53* encontram-se entre os códons 125 e 300, sendo que destas, aproximadamente 88% são mutações do tipo troca de sentido. Esta região gênica compreende os éxons 5, 6, 7 e 8, que codificam o domínio de ligação ao DNA (DLD) de p53. Curiosamente, mutações que ocorrem fora deste domínio, são em sua maioria do tipo sem sentido e de perda de sentido. Além disso, 30% das mutações ocorrem em seis códons preferenciais (175, 245, 248, 249, 273 e 282), todos eles localizados no DLD (Olivier et al., 2010) (**Figura 2**).



Figura 2. Mutações somáticas em TP53. (a) Gráfico representando as frequências de cada classe de mutações somáticas identificadas no gene *TP53* de acordo com o banco de dados da Agência Internacional de Pesquisa em Câncer (IARC). (b) Domínios da proteína p53, salientando seus códons correspondentes, bem como as regiões mais frequentemente alteradas em tumores. TA, domínio de transativação; PR, região rica em prolinas; DBD, domínio de ligação ao DNA; Tet, domínio de tetramerização; Reg, domínio regulatório C-terminal (Brosh and Rotter, 2009).

O padrão de mutações germinativas encontrado em famílias com SLF e LFL é bastante similar ao de mutações somáticas identificadas em tumores, com a maioria delas sendo do tipo sentido trocado (~77%) e ocorrendo nos mesmos *hotspots*. Além disso, apesar de poucos estudos terem investigado a frequência de grandes deleções na síndrome, acredita-se que em torno de 10% dos casos apresentam deleções completas do gene *TP53*. Estudos de correlação genótipo-fenótipo sugerem que estas alterações estão associadas a características mais agressivas relacionadas à manifestação da doença (Bougeard et al., 2003).

1.2.3 A mutação germinativa TP53 R337H no Brasil

No ano de 2001, um grupo de pesquisadores do Paraná identificou a mutação germinativa R337H (p.Arg337His, substituição de uma Arginina por uma Histidina no códon 337 do éxon 10 do gene *TP53*) em 35 de 36 pacientes com

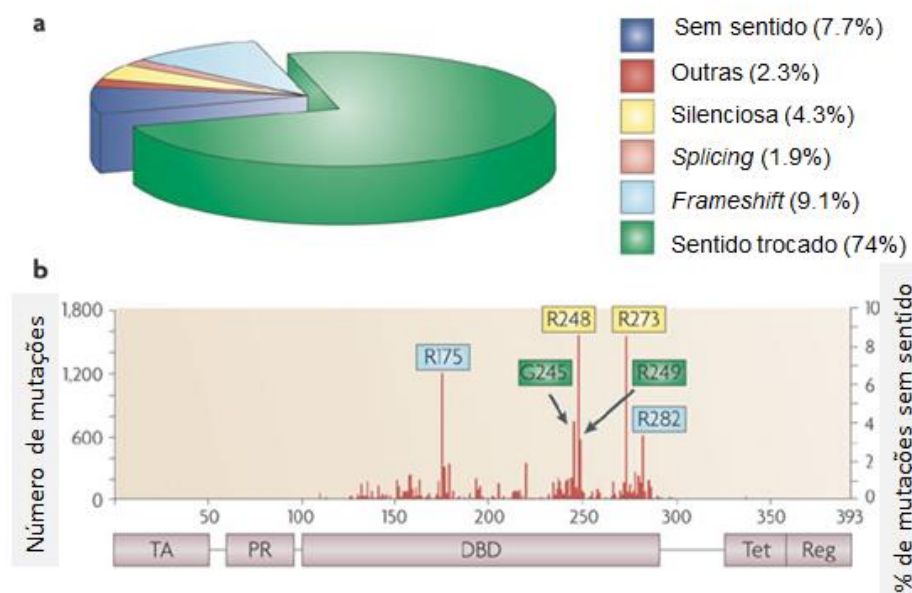
Carcinoma Adrenocortical (CAC). Apesar deste tipo de neoplasia ser um indicativo de SLF e LFL, a frequência e os tipos de câncer observados nas famílias dos pacientes não eram típicos das síndromes e em duas famílias não havia outros casos de câncer. Além disso, a análise da capacidade de transativação de p53-R337H revelou grande similaridade com p53 selvagem ao expressá-las em fibroblastos e linhagens de osteossarcoma (Ribeiro et al., 2001). A partir desses achados os autores propuseram que R337H tratava-se de uma mutação de baixa penetrância para câncer e com efeito tecido-específico, estando relacionada unicamente com a ocorrência de CAC.

Em um estudo subsequente realizado por DiGiammarino et al. (2002) a estrutura e estabilidade de p53-R337H foi avaliada através de análise cromatográfica. Os resultados demonstraram que estruturalmente p53-R337H e p53 selvagem eram muito similares. No entanto, observou-se que a isoforma mutada tornava-se menos estável com o aumento do pH, sendo que aproximadamente 70% do total de proteínas encontrava-se desnaturada em pH 8, enquanto que p53 selvagem só era desnaturada em altas temperaturas. O estudo também sugeriu que na p53 selvagem uma ponte de sal formava-se entre a Arg337 e Asp352. Esta interação seria fundamental para a dimerização e posterior formação do tetrâmero. A substituição de uma arginina por uma histidina na posição 337 introduziria diferenças químicas nesta região, levando a uma desestabilização da ponte de sal e desestruturação do tetrâmero (DiGiammarino et al., 2002) (**Figura 3**).



Figura 3. Estabilidade e estrutura tridimensional de p53-R337H. A esquerda são mostrados gráficos de estabilidade. (a) a figura mostra que à 37°C em pH 8 aproximadamente 70% dos tetrâmeros de p53-R337H estão desnaturados. Ao contrário, em (c) p53 selvagem torna-se desnaturada apenas em temperaturas superiores à 50°C. (b) Estrutura tridimensional do domínio de oligomerização de p53, destacando a posição 337 e a posição 352, que formam uma ponte de sal responsável pela estabilização do tetrâmero. A mudança por uma Histidina na posição 337 desestabiliza a proteína (Modificado de DiGiammarino et al., 2002).

Em 2006, o mesmo grupo do Paraná pesquisou a história familiar de 30 famílias de 41 crianças com CAC do Sul do Brasil. A penetrância de CAC entre portadores de R337H foi estimada em 9.9%, sugerindo que outros fatores ainda não identificados podem interferir no potencial tumorigênico da alteração genética (Figueiredo et al., 2006).

Palmero *et al.* (2008) conduziram um estudo de frequência da mutação R337H em 750 mulheres assintomáticas participantes de um programa de rastreamento mamográfico em Porto Alegre. A mutação foi encontrada na linhagem germinativa de duas mulheres (frequência de 0.3%) que não apresentavam história pessoal de câncer. No entanto, ao se analisar a história familiar verificou-se que ambas pertenciam à mesma família e que esta apresentava história de tumor gástrico, câncer de pâncreas, CM, câncer de pulmão, câncer de cabeça e pescoço e de endométrio. Apesar disso, a família como um todo não preenchia critérios para a LFS e LFL e não havia nenhuma

criança afetada por câncer, apesar de irmandade numerosa (Palmero et al., 2008). Posteriormente, no seguimento desta família foi realizado um diagnóstico de carcinoma adrenocortical em uma criança com menos de um ano e portadora da mutação de R337H.

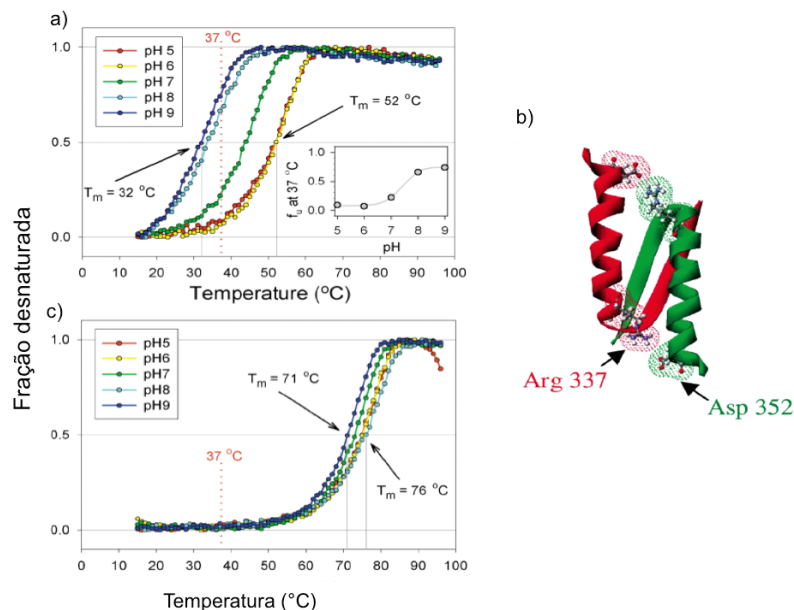
Achatz *et al.* (2007), descreveram pela primeira vez a frequência da mutação R337H em famílias que preenchem definições clínicas da LFS e LFL. Os autores demonstraram que metade das famílias com mutação germinativa identificada em *TP53* apresentavam a mutação pontual R337H na linhagem germinativa. Apesar do espectro tumoral ser bastante similar entre famílias com R337H e famílias com outras mutações localizadas no DLD, indicando que a mutação estava associada a outros tumores além de CAC, a frequência de CAC foi duas vezes maior em famílias com R337H (Achatz et al., 2007).

Trabalhos recentes publicados pelo nosso grupo de pesquisa apontam para algumas características e peculiaridades importantes de R337H em relação a outras mutações de *TP53*. Primeiro, ao contrário do observado no CM desenvolvido por pacientes com mutações germinativas no DLD de *TP53*, em que 63-83% superexpressam a proteína HER2, em casos R337H esta frequência cai para 22.7%, similar a frequência desse fenótipo em amostras não selecionadas de câncer de mama (Fitarelli-Kiehl et al., 2015). Segundo, em um estudo conduzido por Giacomazzi *et al.* (2014) uma alta prevalência de R337H (8.6%) foi encontrada em pacientes com CM e não selecionadas por história familiar, sugerindo que R337H pode ter uma contribuição importante para a alta incidência de CM no Brasil (Giacomazzi et al., 2014). Por fim, Paskulin *et al.* (2015) demonstraram a presença de um mesmo haplótipo ancestral de origem Ibérica em todos os portadores de R337H. No mesmo estudo, a mutação foi datada em 2.000 anos, apontando para uma origem anterior à migração europeia ao Brasil (Paskulin et al., 2015).

No estado do Paraná, o rastreamento da mutação R337H é realizado no âmbito da triagem neonatal desde dezembro de 2005. Entre os primeiros 171,649 recém-nascidos vivos testados, 461 (aproximadamente 0.3%) apresentaram a mutação em heterozigose (Custódio et al., 2013).

1.2.4 p53: estrutura e função

O gene *TP53* (OMIM 191170) está localizado no braço curto do cromossomo 17 (17p13.1) e é composto por onze éxons, sendo o primeiro não codificante. O produto proteico de *TP53*, a proteína p53, codifica uma molécula (monômero) composta por 393 aminoácidos (Linzer and Levine, 1979). Para que a proteína p53 se torne ativa, sendo capaz de ligar-se diretamente ao DNA e exercer sua função como um fator de transcrição, é sabido que os monômeros de p53 precisam, inicialmente, se dimerizar e, posteriormente, formar um tetrâmero (dímero de dímeros) (Kitayner et al., 2006).

Cada monômero de p53 está organizado em domínios bem definidos. Na região N- terminal da molécula (códon 1-62) encontram-se dois domínios de transativação (*Transactivation Domain 1* - TDA1 -, e *Transactivation Domain 2* – TDA2) responsáveis pela regulação da maquinaria de transcrição de genes regulados positivamente por p53. A seguir (resíduos 63-97), encontra-se um domínio rico em prolinas (*Proline Rich Region* – PRR) envolvido na interação proteína-proteína e na função pró-apoptótica de p53. Na região central está localizado o domínio de ligação ao DNA - DLD (*DNA Binding Domain* – DBD) (resíduos 94-312), uma região altamente conservada evolutivamente e que interage diretamente com sequências nucleotídicas específicas de genes alvos. No DLD estão a grande maioria das mutações somáticas encontradas em tumores e, também, na linhagem germinativa de pacientes com SLF/LFL. Por fim, a região C- terminal é formada por um domínio de oligomerização (*Oligomerization Domain* – OD) (resíduos 325-355), fundamental para dimerização e posterior tetramerização, e por um domínio básico não estruturado importante para a fosforilação de p53 (Hollstein and Hainaut, 2010; Levine, 1997a).

Mais de trinta anos atrás, p53 foi identificada por sua capacidade de interação com o antígeno T do vírus SV40 e, também, por ser frequentemente detectada em altos níveis em células tumorais, sendo assim classificada como uma proteína oncogênica (Lane and Crawford, 1979; Linzer and Levine, 1979). Essa visão perdurou por quase uma década, até que alguns trabalhos demonstraram que p53 selvagem funcionava como uma proteína supressora de

tumor e indicando que os primeiros trabalhos haviam, na verdade, estudado tumores com p53 mutante (Weisz et al., 2007). Evidências adicionais acerca da real função de p53 em neoplasias vieram de estudos demonstrando que tanto mutações somáticas quanto germinativas eram seguidas por inativação do alelo selvagem (perda de heterozigosidade, condizente com a hipótese de dois eventos mutacionais relacionada aos genes supressores tumorais), o que sugeria que a inativação completa de p53 era condicional para o desenvolvimento de uma grande parcela dos tumores (Brosh and Rotter, 2009).

De todas as proteínas supressoras de tumor, poucas são tão versáteis e exercem funções tão antagônicas como p53. Conhecida como “guardiã do genoma”, p53 é uma proteína nuclear expressa em praticamente todos os tecidos de forma latente. Sua principal função é atuar na resposta a dano de DNA por impedir a proliferação de células que sofreram alguma alteração em seu material genético. Seu principal mecanismo de ação é como fator de transcrição que, em condições fisiológicas, apresenta uma meia-vida de aproximadamente 5 a 20 minutos (Hollstein et al., 1991; Levine, 1997b; Nigro et al., 1989b).

Mecanismos que levam a estresse celular, tais como dano ao DNA, hipóxia, estresse oxidativo, sinalização oncogênica, encurtamento telomérico, estresse ribossomal e privação de nutrientes estão entre os mais bem conhecidos mecanismos ativadores de p53. Diante de tais condições celulares, p53 se acumula no núcleo e, de acordo com natureza e intensidade do estresse, tipo celular e “*background genético*”, determina o tipo de resposta celular a ser desencadeado. As respostas celulares mediadas por p53 mais bem conhecidas e caracterizadas são: apoptose, parada de ciclo celular, reparo do DNA, vias metabólicas, senescência e inibição de angiogênese e metástase (Horn and Vousden, 2007) (**Figura 4**).



Figura 4. Mecanismos ativadores da proteína p53 e suas atividades supressoras de tumor. p53 tem como função integrar respostas celulares (em azul) a diferentes tipos de estresse (em vermelho). Cada uma das vias de sinalização mediadas por p53 é ativada pela expressão de diferentes proteínas (em laranja) (Modificado de Vousden and Lane, 2007).

Em condições fisiológicas, p53 encontra-se em baixos níveis celulares, tendo como principal regulador negativo a proteína mdm2. A formação do complexo p53/mdm2 possibilita o redirecionamento da p53 do núcleo para o citoplasma, onde mdm2 age como uma ubiquitina-ligase, possibilitando a degradação de p53 pelo proteossomo (Moll and Petrenko, 2003).

p53 na regulação do metabolismo energético e oxidativo

Reprogramação metabólica foi descrita como uma característica importante das células neoplásicas, visto que a desregulação nos processos de proliferação e sobrevivência celular requerem ajustes do metabolismo energético. Neste contexto, estudos pioneiros conduzidos por Otto Warburg mostraram que mesmo sob condições aeróbicas, células tumorais limitam seu metabolismo energético a glicólise, processo esse conhecido como Efeito Warburg (Hanahan and Weinberg, 2011). Para compensar a baixa produção de ATP gerada pela via glicolítica em relação àquela produzida pela fosforilação oxidativa mitocondrial, tem sido

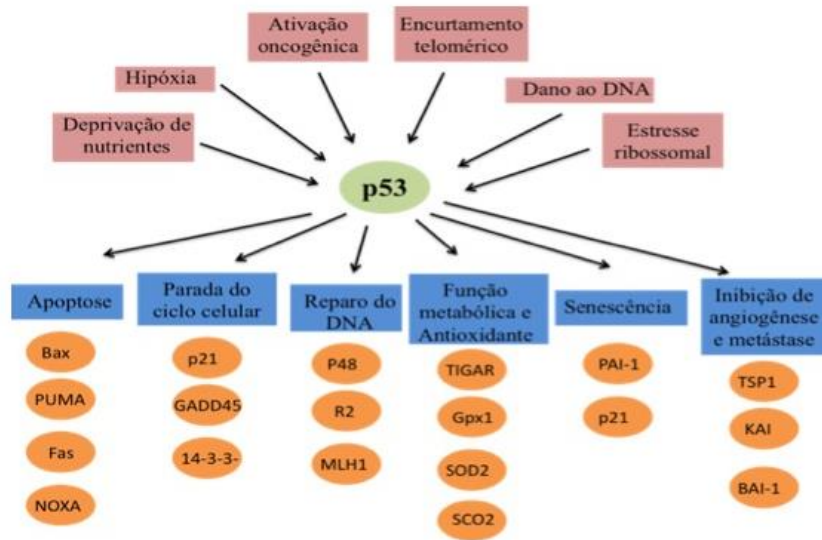
demonstrado que células tumorais aumentam sua captação de glicose, em parte, por aumentar a expressão de *GLUT1* (DeBerardinis et al., 2008). Além disso, o processo de reprogramação do metabolismo energético de células tumorais tem sido associado a mutações nos genes *MYC*, *RAS* e *TP53* (Jones and Thompson, 2009).

Mais recentemente, diversos estudos demonstraram o papel de p53 como um antagonista do Efeito Warburg. Essa função metabólica deve-se, principalmente, ao fato de p53 diminuir a captação celular de glicose, induzir a expressão de genes inibidores da via glicolítica e favorecer a respiração mitocondrial (Aylon and Oren, 2011) (**Figura 6**). Além disso, p53 também regula indiretamente o metabolismo energético através da via de mTOR. Sob condições de estresse metabólico, p53 ativa AMPK, TSC2 e PTEN, genes que por sua vez regulam negativamente mTOR (Feng et al., 2005).



Figura 5. Regulação metabólica desempenhada por p53. (a) p53 inibe glicólise e ativa fosforilação oxidativa. Genes regulados positivamente e negativamente estão em verde e laranja, respectivamente. (b) p53 induz a transcrição de inúmeros inibidores de mTOR, regulando assim negativamente o crescimento celular (Aylon e Oren, 2011).

Além de funções relacionadas a regulação do metabolismo energético, mais recentemente alguns estudos demonstraram que sob determinadas

condições fisiológicas p53 exerce funções muito distintas das descritas anteriormente. Sablina *et al.* (2005) demonstraram que tanto o silenciamento de p53 por diferentes mecanismos, como a superexpressão de mutantes oncogênicas (p53 Arg175His), aumentavam significativamente a produção de espécies reativas de oxigênio (ERO) quando comparado a células com p53 selvagem. O bloqueio da expressão de p53 também foi seguido por uma diminuição ou ausência da expressão de algumas enzimas antioxidantes, como GPx1 e SESN2, aumento na oxidação do DNA, mutagênese e anormalidades no cariótipo, mais comumente aneuploidias. Por fim, o estudo demonstrou que camundongos *knock-out* (*TP53^{-/-}*) suplementados com N-acetilcisteína eram significativamente menos propensos a tumores do que os mesmos animais sem a suplementação (Sablina *et al.*, 2005).

Alguns estudos anteriores já haviam identificado o papel de p53 na modulação da expressão de enzimas com funções antioxidantes, tais como superóxido dismutase 2 mitocondrial (SOD2) (Hussain *et al.*, 2004), glutathione peroxidase 1 (GPX1) (Tan *et al.*, 1999), aldeído desidrogenase 4, membro A1 (ALDH4A1) (Yoon *et al.*, 2004), e sestrinas (HI95 e PA26) (Budanov *et al.*, 2004).

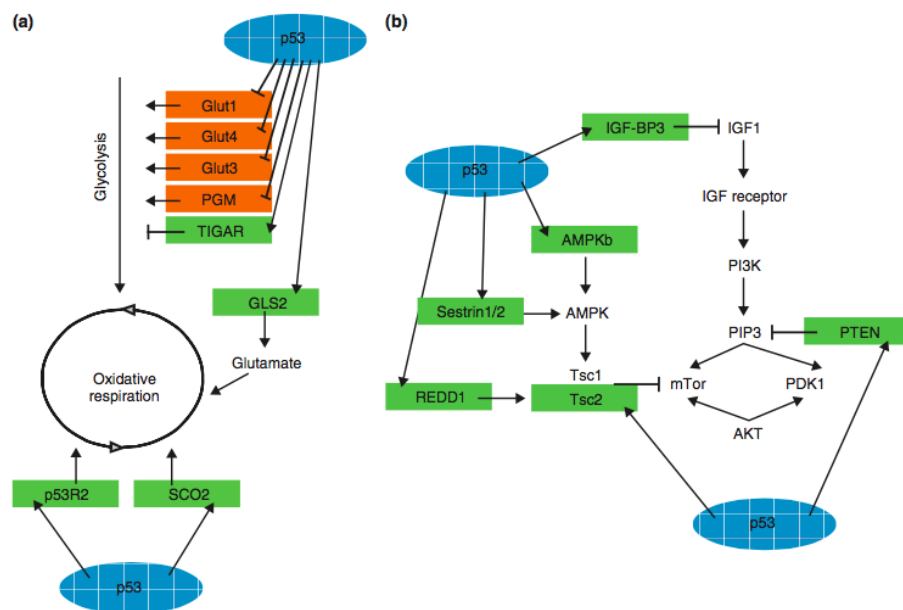
p53 na resposta a dano de DNA

A habilidade de promover parada de ciclo celular e apoptose é um mecanismo eficiente de proteção contra tumores. Neste contexto, a indução de dano de DNA, como por exemplo quebras bifilamentares do DNA, ativa a proteína ATM que por sua vez induz a expressão de ATR cinase. ATR, e sob determinadas condições ATM, são capazes de diretamente fosforilar p53, protegendo-a da degradação. p53 ativada tem como alvo transcricional p21. Dentre as inúmeras funções desempenhadas por p21 está o controle do ciclo celular e a capacidade de suprimir sinais proliferativos e de crescimento na presença de algum dano de DNA (Roos and Kaina, 2006).

Indução de apoptose é um dos mais bem conhecidos efeitos biológicos de p53 (Oren, 2003). A indução e/ou repressão por p53 selvagem de dezenas de genes envolvidos na regulação da via apoptótica, tanto na via intrínseca quanto

extrínseca, é bem descrita. Na via extrínseca, que envolve a sinalização extracelular através de receptores mediadores de morte, p53 selvagem ativa a expressão de alguns genes codificantes de receptores de morte celular, tais como *APO1/FAS/CD95* e *KILLER/DR5* (Wu et al., 2000). Já na via intrínseca, que integra múltiplos sinais intracelulares, p53 desempenha funções dependentes e independentes da transcrição de genes. Dentre os genes regulados transcricionalmente por p53, estão *PUMA*, *NOXA* e *BAX*. Juntamente com a proteína anti-apoptótica Bcl2 estes genes alteram a integridade da membrana mitocondrial externa, permitindo a liberação de fatores apoptóticos, tais como citocromo C (Shamas-Din et al., 2011). Dentre os mecanismos de morte celular que independem da transcrição de genes, esta a desregulação do reparo do DNA por excisão de bases e a consequente morte celular por acúmulo de lesões no material genético (Gatz and Wiesmüller, 2006).

A proteína p53 também desempenha um função importante na indução de senescência em resposta a estresse. Alguns estudos demonstraram que tanto ativação oncogênica quanto o encurtamento de telômeros desencadeiam senescência induzida por p53. Lesões pré-cancerosas, que surgem constantemente em inúmeras células do corpo humano, parecem ser eficientemente desviadas da progressão maligna pelo mecanismo de senescência envolvendo a sinalização de p53. Além disso, já foi demonstrado que carcinomas e sarcomas utilizam preferencialmente esta via, em detrimento da via de apoptose, mesmo sendo esta uma resposta que atua muito mais na estabilização do que na eliminação de um tumor (Deng et al., 2008; Ventura et al., 2007; Xue et al., 2007). Assim como ocorre com as vias de sinalização mediadas por p53 citadas anteriormente, senescência resulta de mudanças na expressão de inúmeras proteínas, tais como o inibidor do ativador de plasminogênio tipo 1 (PAI-1) (Leal et al., 2008). Já foi demonstrado que a supressão de tumor por defeitos na via de apoptose (mutação R172P em *TP53*) é dependente da ativação de p21 e senescência (Cosme-Blanco et al., 2007).

Em modelos animais foi observado que a expressão de p53 mutante leva a uma perda na habilidade de indução de parada de ciclo celular, mas não de

apoptose, o que ainda os mantém protegidos contra o desenvolvimento de tumores espontâneos (Toledo et al., 2008).

1.2.5 p53 mutante e seus efeitos biológicos

Mutações no gene *TP53* podem ser classificadas em duas principais classes, de acordo com seu efeito na estabilidade termodinâmica da proteína. A primeira classe, as chamadas mutações de perda de contato (*DNA-contact mutations*), inclui principalmente as mutações que interferem na capacidade de p53 ligar-se ao DNA, como o que ocorre com as mutações R248Q e R273H. Já o segundo grupo engloba as mutações que causam distorções conformacionais locais, tais como R249S e G245S, ou globais, como R175H e R282W (*conformational mutations*). Classicamente, estas mutações levam a perda de função, evidenciada por defeitos na parada de ciclo celular, reparo do DNA e apoptose (Bullock and Fersht, 2001).

Mutações que levam a alterações na capacidade de ligação ao DNA também conferem, na sua grande maioria, um efeito dominante negativo da proteína mutante sobre a proteína selvagem, fenômeno este dependente da hetero-oligomerização de monômeros selvagens e mutantes. No entanto, no caso de p53, em que perda de heterozigotidade é frequentemente observada durante a progressão de tumores, este mecanismo parece ser transiente (Rivlin et al., 2011).

Além de perda de função e atividade dominante negativa, algumas mutações também foram associadas a ganho de propriedades oncogênicas (ganho de função). As primeiras evidências de mutações de ganho de função em *TP53* vieram de estudos em que formas mutantes da proteína induziam formação de tumores em camundongos. Posteriormente, vários outros trabalhos demonstraram a capacidade em induzir proliferação celular, causar resistência a drogas, invasão, angiogênese e inflamação. Além disso, mecanismos de ganho de função explicam, pelo menos em parte, o pior prognóstico encontrado em tumores com mutações somáticas de *TP53* (Oren and Rotter, 2010).



Figura 6. Figura mostrando os principais mecanismos associados a mutações no gene *TP53*. DN, Dominante negativo (adaptado de Brosh e Rotter, 2009).

Até o momento, o impacto funcional de mutações em *TP53* foi estudado de diferentes maneiras, incluindo estudos de transativação, capacidade de indução de parada do ciclo celular e apoptose, habilidade da proteína mutante exercer efeito dominante negativo, sensibilidade à temperatura, etc. A investigação mais abrangente realizada até o momento foi feita por Kato *et al.* (2003). Neste estudo, a análise sistemática de todas as 2,314 possíveis mutações de troca de sentido em *TP53* demonstrou que 36% dos mutantes são funcionalmente inativos, com grande parte destes localizados no DLD de p53. Da mesma forma, alterações no domínio de tetramerização de p53 foram altamente suscetíveis a inativação funcional, ao contrário das alterações na região N- e C- terminal da proteína, que raramente afetam a função de p53 (Kato *et al.*, 2003).

1.2.6 Impacto de mutações na Síndrome Li-Fraumeni

Apesar de alguns esforços na tentativa de elucidar os mecanismos de doença na SLF e LFL, pouco se sabe sobre os aspectos patofisiológicos da

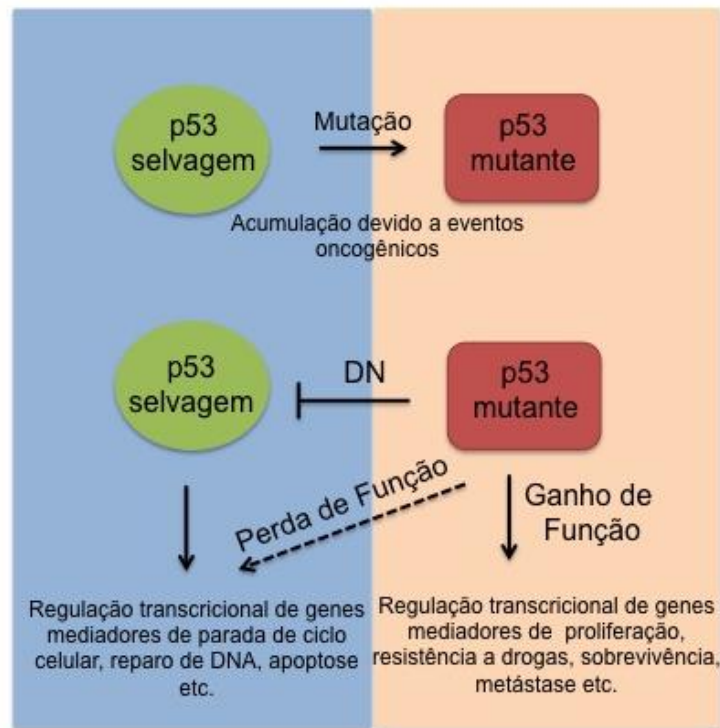
predisposição ao câncer em indivíduos acometidos pela doença. Na última década, apesar de alguns estudos terem demonstrado alterações em diferentes processos biológicos em portadores de mutações em *TP53* (Figura 10), poucos avanços relacionados a novas abordagens terapêuticas para este subgrupo de pacientes foram obtidos. Além disso, devido em parte a raridade da síndrome, a maioria dos estudos são esparsos e, muitas vezes, puramente descritivos.



Figura 7. Consequências de mutações germinativas em *TP53* em diferentes mecanismos celulares (Macedo e Ashton-Prolla, manuscrito em preparação).

Conforme descrito anteriormente, p53 desempenha um papel central nos mecanismos de resposta à dano e reparo de lesões de DNA. Alterações na via de reparo por excisão de nucleotídeos (*Nucleotide Excision Repair*, NER), principalmente por defeitos no reparo de dímeros de pirimidina causados por exposição a UVB, já foram identificadas em fibroblastos de pacientes com a SLF (Zhu et al., 2000). Da mesma forma, defeitos no reparo de quebras bifilamentares de DNA, evidenciados através dos altos níveis da proteína γ -H2AX após indução de dano por radiação ionizante (RI), também já foram encontrados em células de pacientes (Mirzayans et al., 2006). Além das evidências *in vitro* em relação ao

comprometimento de vias de reparo de DNA e radiosensibilidade, alguns relatos de caso também sugerem aumento no risco de um segundo tumor, após o tratamento com radioterapia, em pacientes com SLF. Assim, apesar de alguns resultados contraditórios, tem sido sugerido que o tratamento radioterápico deve ser evitado para pacientes com SLF, apesar da fragilidade das evidências a favor ou contra um efeito claramente deletério (Wong and Han, 2014; Heymann et al., 2010; Limacher et al., 2001).

Alguns estudos também relataram maior frequência de alterações cromossômicas numéricas e estruturais em células de portadores de mutações em *TP53* quando comparado a células de indivíduos sem mutações neste gene (Boyle et al., 1998). Evidência de instabilidade genômica por alterações no perfil de número de cópias de DNA (maiores índices de perdas e ganhos de regiões cromossômicas) também foi encontrada em pacientes com SLF quando comparado a controles (Shlien et al., 2008).

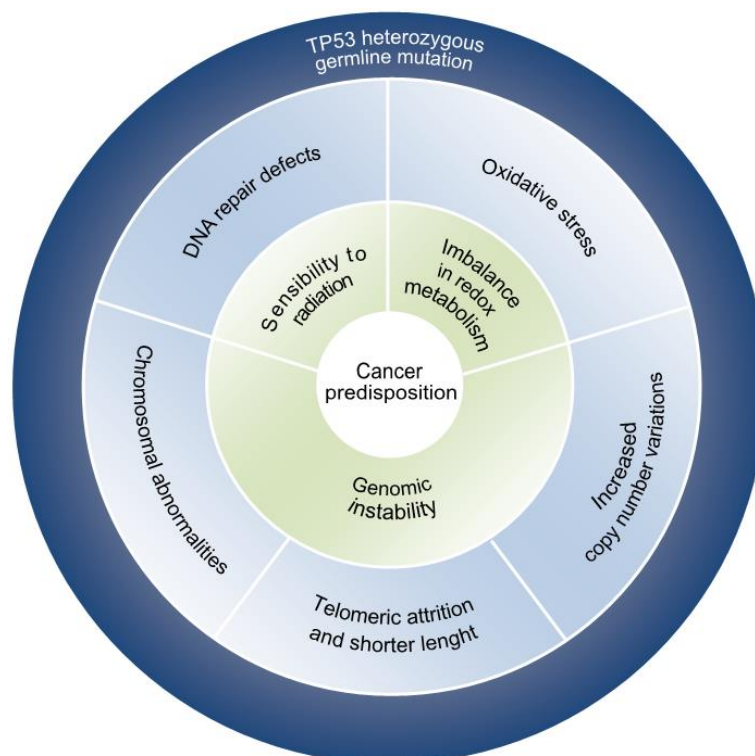
A função dos telômeros na estabilidade genética e proteção contra tumores já é bem descrita (O'Sullivan and Karlseder, 2010). Em algumas famílias com SLF, foi observado aumento na incidência de câncer e na severidade das manifestações clínicas em sucessivas gerações. Trkova *et al.* (2007) demonstraram pela primeira vez uma associação entre comprimento telomérico e alterações em p53. Neste estudo foi observado telômeros significativamente mais curtos em portadores de mutações em *TP53* quando comparado a não portadores de idades correspondentes, com uma diferença mais pronunciada entre crianças (Trkova et al., 2007). No mesmo ano, Tabori *et al.* (2007) observou este mesmo padrão entre pacientes Li-Fraumeni com e sem diagnóstico prévio de câncer. Comprimento telomérico como um mecanismo de antecipação genética foi sugerido neste mesmo estudo, visto que crianças com SLF apresentavam telômeros mais curtos do que adultos com a doença (Tabori et al., 2007).

Mais recentemente, alguns trabalhos demonstraram alterações metabólicas em pacientes com SLF/LFL. Em um estudo publicado por nosso grupo de pesquisa foi demonstrado que portadores da mutação R337H, em relação ao grupo de não portadores, apresentou um aumento significativo no dano oxidativo tanto a proteínas ($P = 0.035$) quanto a lipídios ($P < 0.0001$). Além disso, a análise

do perfil antioxidante demonstrou que os indivíduos positivos para R337H apresentavam baixos níveis de ácido ascórbico ($P < 0.0001$), e um aumento no conteúdo total de antioxidantes não enzimáticos ($P = 0.007$). Estes achados foram independentes da história pessoal de câncer, o que indica que as alterações encontradas são um efeito direto da mutação e não da manifestação da doença (Macedo et al., 2012). Posteriormente, Wang *et al.* (2013) reforçaram o impacto de mutações de DLD em *TP53* na fisiologia mitocondrial, visto que células de pacientes com SLF apresentaram significativo aumento no consumo de oxigênio e, também, na biomassa mitocondrial (Wang et al., 2013).

1.3 Genes *BRCA1* e *BRCA2*

1.3.1 Epidemiologia do câncer de mama

O CM é o tipo de câncer mais frequente entre as mulheres em todo o mundo, seja em países desenvolvidos ou não. No último levantamento global realizado no ano de 2012 foram estimados 1,67 milhões de novos casos dessa neoplasia em todo o mundo, representando, no total, 25% de todos os tumores diagnosticados em mulheres. A incidência de CM varia entre as diferentes regiões do mundo, com as maiores taxas na Europa Ocidental (96/100 mil) e as menores na África Central e na Ásia Oriental (27/100 mil) (Ferlay et al., 2015; GLOBOCAN 2012).

Nos Estados Unidos, estima-se que 231.840 mulheres foram diagnosticadas com CM em 2015, o que corresponde a 14% de todos os casos de câncer do país. Além disso, estima-se que houve mais de 40 mil mortes decorrentes da doença. Embora a idade média ao diagnóstico nos EUA seja de 61 anos, 20% dos casos de CM são diagnosticados em mulheres abaixo dos 50 anos de idade, enquanto 40% dos casos são diagnosticados em mulheres acima dos 65 anos (Siegel et al., 2015).

No Brasil, o Instituto Nacional de Câncer (INCa) estima que 57.960 novos casos de CM serão diagnosticados em 2016, com taxas de incidência aproximadas de 71/100 mil no Sudeste, 70/100 mil no Sul, 51/100 mil no Centro-Oeste, 36/100 mil no Nordeste e 21/100 mil na região Norte do país (INCA 2014;

INCA 2016). Do total de casos diagnosticados, estima-se que 14.388 casos evoluam a óbito (INCA 2016). As taxas de mortalidade por CM permanecem elevadas muito provavelmente porque a doença ainda é diagnosticada em estádios avançados, diferente do que acontece em países desenvolvidos, como os EUA, onde 60,8% das mulheres recebem o diagnóstico quando a doença ainda é localizada.

Em relação a sobrevida, na população mundial, a sobrevida média após cinco anos do diagnóstico é de 61% (SEER, 2016). Nos EUA, a sobrevida livre de doença em cinco anos é de 98,5% para pacientes com doença localizada, 84,9% para doença regional e 25,9% para doença em estágio avançado. Além do estágio da doença, outros fatores como grau de diferenciação tumoral, status de receptores hormonais e status HER2 também influenciam na taxa de sobrevida (SEER, 2016).

1.3.2 Câncer de mama hereditário associado a mutações em *BRCA1* e *BRCA2*

Apesar do CM ser classicamente considerado uma doença multifatorial, o que significa que tanto fatores genéticos quanto ambientais estão envolvidos na manifestação da doença, estudos de ligação gênica em famílias com múltiplos casos de CM e evidência de transmissão vertical, resultaram na identificação de dois genes de alta penetrância: *BRCA1* e *BRCA2* (Miki et al., 1994; Wooster et al., 1995). Hoje, estima-se que pelo menos 10% de todos os casos de CM seja de etiologia hereditária. Estes decorrem, fundamentalmente, por mutações germinativas nos genes *BRCA1* e *BRCA2*.

São várias as síndromes de predisposição hereditária ao câncer que incluem alto risco para CM, sendo que a Síndrome de Predisposição Hereditária ao Câncer de Mama e Ovário ou HBOC (do inglês, *Hereditary Breast and Ovarian Cancer*) é a mais bem conhecida. HBOC é uma síndrome de alta penetrância com padrão de herança autossômico dominante e associada a mutações herdadas nos genes *BRCA1* e *BRCA2*. Estima-se que 5-7% de todos os casos de câncer mama estejam associados à HBOC (Roy et al., 2012). Já em mulheres com

história pessoal de CM, aproximadamente 30% e 29% apresentam mutações herdadas em *BRCA1* e *BRCA2*, respectivamente (**Figura 7**) (Castéra et al., 2014).



Figura 7. Genes associados ao CM hereditário. Distribuição de mutações em genes de predisposição ao câncer identificadas em uma coorte de mulheres com CM (Castéra et al., 2014).

Os primeiros estudos realizados em famílias com forte história familiar estimaram o risco de desenvolvimento de CM em até 85% e 84% para portadores de mutações em *BRCA1* e *BRCA2*, respectivamente (Easton et al., 1995; Ford et al., 1995). Mais recentemente, estudos avaliando pacientes independentemente de suas histórias familiares, demonstraram que este risco é relativamente menor, sendo de aproximadamente 60% para portadoras de mutações em *BRCA1* e 30-56% para *BRCA2*, até os 70 anos de idade (Struewing et al., 1997; Thorlacius et al., 1997).

Câncer de mama em pacientes portadoras de mutação ocorre, em geral, mais precocemente do que na população em geral, e não raramente acomete as duas mamas. Adicionalmente, mulheres com mutações em *BRCA1* tem um risco elevado de desenvolver tumores de ovário, trompas de falópio e/ou peritônio (Brose et al., 2002; Finch et al., 2006). Portadores de mutações em *BRCA1* ou *BRCA2* também apresentam um risco maior de desenvolver tumores de próstata e pâncreas (Ferrone et al., 2009; Levy-Lahad and Friedman, 2007).

Mutações germinativas em *BRCA2* também estão associadas a um aumento de aproximadamente 8% no risco de desenvolvimento de tumores da mama ao longo da vida em homens. Embora estes tumores correspondam a menos de 1% dos casos de CM, uma proporção significativa dos casos de CM masculino surgem em um contexto de história familiar de câncer de mama e ovário (Lynch et al., 1998). Já a associação entre mutações em *BRCA1* e o risco de desenvolvimento de CM em homens é menos clara (Tai et al., 2007).

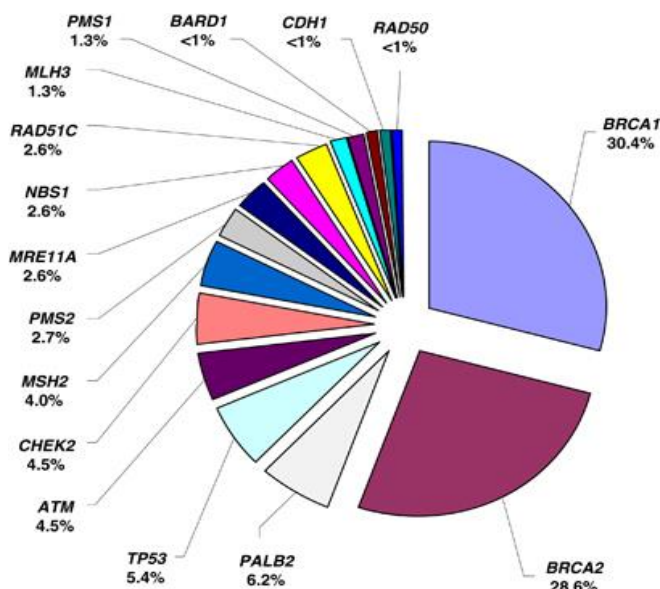
Quando em homozigose, mutações germinativas em *BRCA2* causam anemia de Fanconi. Esta é uma síndrome de instabilidade cromossômica que, entre outros sintomas, predispõe ao desenvolvimento de diversos tumores (Howlett et al., 2002). Mais recentemente relatos de caso revelaram pacientes homozigotos para mutações germinativas em *BRCA1*, com fenótipos graves, semelhantes à anemia de Fanconi (Domchek et al., 2013; Sawyer et al., 2015)

1.3.3 *BRCA1* e *BRCA2*: estrutura e função

BRCA1 é um gene supressor de tumor localizado no braço longo do cromossomo 17, na posição 17q21, e contém 24 exons, sendo 22 codificantes. O alelo selvagem produz um RNA mensageiro de 7,8 kb (LRG_292t1), que codifica a proteína *breast cancer type 1 susceptibility protein* (*BRCA1*), que por sua vez é composta de 1.863 aminoácidos organizados em diferentes domínios proteicos, como um *RING-finger* próximo à cadeia N-terminal, dois domínios de localização nuclear no exon 11, e o domínio BRCT na porção C-terminal (Miki et al., 1994; Narod and Foulkes, 2004; Narod and Offit, 2005).



Figura 8. Domínios funcionais de BRCA1 e BRCA2. O esquema mostra os sítios de interação de BRCA1 com BRCA2 e destas com diversas outras proteínas essenciais para a manutenção da integridade genômica (Retirado de West, 2003).

O gene *BRCA2* está localizado no braço longo do cromossomo 13, na posição 13q12.3, e foi relacionado ao CM em 1995 (Wooster et al., 1995). O gene contém 27 exons, todos codificantes, e distribuídos em aproximadamente 70.000 pb. O alelo selvagem produz um RNA mensageiro de 10,4 kb (LRG 293t1), que codifica uma proteína de 3.418 aminoácidos, a *breast cancer type 2 susceptibility protein* (BRCA2) (Tavtigian et al., 1996; Wooster and Weber, 2003).

Apesar da ampla variedade de funções exercidas por BRCA1 e BRCA2 em inúmeros processos biológicos, classicamente ambas proteínas tem sido descritas por seu papel primário no reparo de quebras bifilamentares do DNA por recombinação homologa (RH) (Moynahan et al., 1999; Moynahan et al., 2001). A RH é um processo complexo e que envolve inúmeras proteínas, muitas delas já conhecidas por seu papel na suscetibilidade ao CM.

A primeira etapa da RH envolve o reconhecimento das quebras bifilamentares de DNA por ATM e ATR, que então fosforilam e ativam CHEK2, p53, BRCA1 e H2AX. BRCA1, por sua vez, juntamente com BARD1 e BRIP1, atuam como organizadores das demais proteínas no sítio de quebra. Um complexo formado pelas proteínas MRE11, RAD50 and NBS1 degrada regiões específicas adjacentes ao local da quebra, permitindo assim que a proteína RPA ligue-se a uma extremidade 3' livre. Nesta etapa do processo a proteína BRCA2 é recrutada com o auxílio de PALB2, permitindo a localização de RAD51 no sítio de dano ao DNA. A partir disso, ocorre a invasão da fita de DNA no cromossomo homólogo, que então serve de molde para a síntese de material genético. A RH é considerada um mecanismo de reparo de DNA conservativo, com alta taxa de fidelidade (Walsh, 2015).

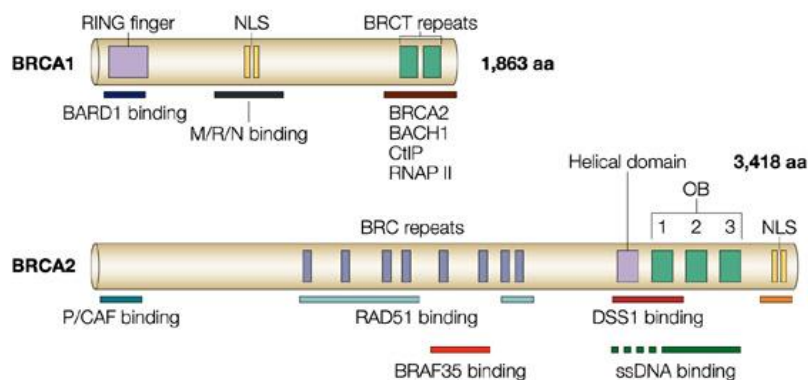
1.3.4 O conceito de letalidade sintética entre BRCA e PARP1

A maioria das novas terapias desenvolvidas para pacientes com mutações herdadas em *BRCA1* ou *BRCA2* exploram o fato destes tumores apresentarem

completa deficiência no mecanismo de reparo de quebras bifilamentares de DNA por RH (Evers et al., 2010). Apesar dos avanços e dos inúmeros estudos clínicos que encontram-se em andamento, atualmente o tratamento para o CM diagnosticado neste subgrupo de pacientes ainda baseia-se na expressão de receptores hormonais e de HER2, exatamente como ocorre com casos esporádicos da doença (Maxwell and Domchek, 2012). Já para o câncer de ovário associado a alterações em *BRCA1* e *BRCA2*, Olaparib (AZD2281 ou Lynparza), uma droga usada no contexto de deficiência de RH, já está aprovada pelo FDA.

O conceito de letalidade sintética tem sido a base para o desenvolvimento das novas drogas direcionadas para tumores que surgem em pacientes diagnosticados com HBOC. Este fenômeno baseia-se na completa deficiência das proteínas BRCA1 ou BRCA2, que ocorre em decorrência de uma mutação germinativa (primeiro evento) acoplada a inativação somática do alelo selvagem (segundo evento), ou a partir de dois eventos somáticos, em conjunto com a inibição farmacológica de uma segunda proteína (**Figura 9**). Neste contexto, as drogas que encontram-se em fases mais adiantadas de estudos clínicos são as chamados inibidoras de PARP (Dedes et al., 2011).



Figura 9. Mecanismo de letalidade sintética. Figura exemplificando o conceito de letalidade sintética entre a deficiência da proteína BRCA1 ou BRCA2 e a inibição farmacológica de PARP (Ashworth et al., 2011).

As PARPs são uma grande família de enzimas, que dentre outras funções, desempenham um papel central no reparo de quebras bifilamentares de DNA através da via de reparo por excisão de bases (*Base Excision Repair*, BER) (Ashworth, 2008). Em 2005 duas publicações simultâneas demonstraram o impacto da inibição da enzima PARP1 (poli ADP-ribose polimerase 1) em células com deficiência completa de BRCA1 e BRCA2 (Bryant et al., 2005; Farmer et al., 2005). O tratamento destas células com Olaparib induziu altos índices de instabilidade genômica, parada de ciclo celular e de apoptose.

Atualmente, Niraparib (MK-4827), BMN 673 e Rucaparib (AG014699) são exemplos de drogas que encontram-se em diferentes fases de testes clínicos, e assim como Olaparib, baseiam-se no contexto de letalidade sintética entre BRCA e inibição de PARP (Sandhu et al., 2013).

1.3.4 Imunofenótipo e genômica do CM associado a mutações em BRCA1/2

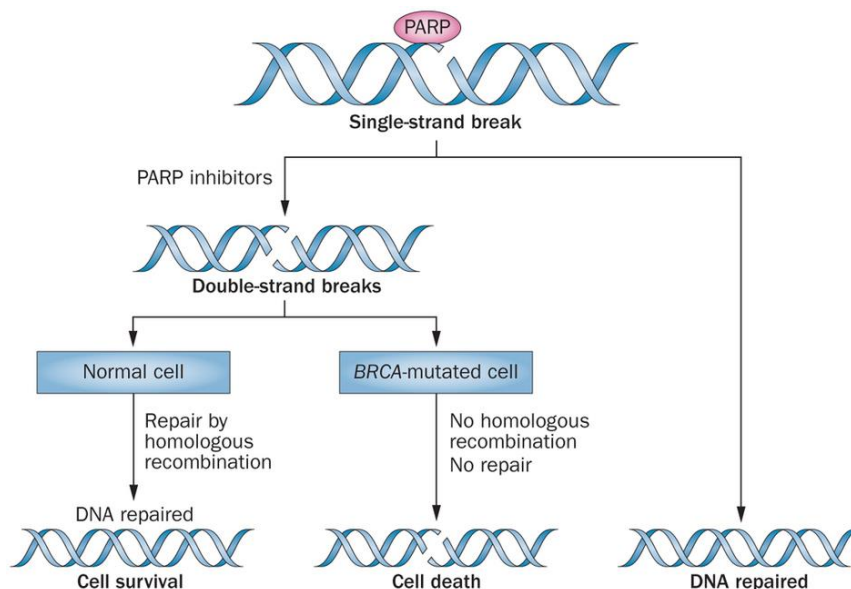
Carcinoma ductal invasor da mama representa o tipo histológico de câncer mais comum em portadores de mutações em *BRCA1* e *BRCA2* (Honrado et al., 2006). Tumores diagnosticados em pacientes com mutações em *BRCA1* apresentam, geralmente, altos índices mitóticos, frequente comprometimento de linfonodos axilares e alto grau (aproximadamente 80% dos casos). Já tumores desenvolvidos por portadores de mutações em *BRCA2* são mais heterogêneos, com aproximadamente 40% e 50% destes sendo de grau 2 e 3, respectivamente.

Apesar do primeiro evento mutacional (mutação germinativa) que confere a predisposição ocorrer em genes com funções relacionadas, tumores da mama diagnosticados em portadores de mutações em *BRCA1* e *BRCA2* apresentam imunofenótipos distintos. Nos casos de CM relacionados a *BRCA1*, aproximadamente 70-80% são negativos para a expressão do receptor de estrógeno (RE), receptor de progesterona (RP) e para HER2, sendo assim classificados como triplo-negativos. Já casos relacionados a *BRCA2* são majoritariamente positivos para RE (Mavaddat et al., 2012). Além disso, alguns trabalhos relatam frequências similares para a expressão de RE e RP entre o casos associados a *BRCA2* e esporádicos (Palacios et al., 2005).

Por muito tempo se especulou a possível relação entre fenótipo triplo-negativo do CM e alterações no gene *BRCA1*. Apesar de muitas questões ainda não terem sido respondidas, alguns estudos *in vitro* demonstraram uma regulação direta do RE por *BRCA1* (Gorski et al., 2009). Além disso, também foi demonstrado experimentalmente que estes tumores originam-se de células progenitoras do lúmen mamário, e que estas são fundamentalmente negativas para a expressão do RE (Molyneux et al., 2010). Alguns autores sugerem que os casos de CM associados a *BRCA1* e positivos para a expressão do RE (20-30% dos casos) não estão relacionados a deficiência de *BRCA1*, mas sim, constituem doenças de caráter esporádico.

Apesar de poucos trabalhos terem avaliado a composição das alterações somáticas presentes nos tumores associados aos genes *BRCA1* e *BRCA2*, algumas características já são conhecidas. Estudos realizados utilizando sequenciamento de nova geração (do inglês *Next Generation Sequencing*, NGS) demonstraram, em um pequeno número de casos, que do ponto de vista molecular estes tumores são bastante heterogêneos. O único gene que parece estar mutado em alta frequência (80%) entre os casos associados a *BRCA1* é *TP53* (Crook et al., 1997; Martins et al., 2012). Amplificação do oncogene *MYC* também ocorre em uma parcela significativa dos casos associados tanto a *BRCA1* quanto a *BRCA2* (Palacios et al., 2003).

Em um estudo realizado por Martins et al. (2012) a cronologia dos eventos moleculares do CM desenvolvido por portadores de mutações germinativas em *BRCA1* foi investigada ao nível de células únicas (*single cell approach*). Através da análise de três principais marcadores moleculares, que incluiu mutações no gene *TP53*, perda da proteína PTEN e perda do alelo selvagem de *BRCA1* (perda de heterozigossidade), foi demonstrado que o primeiro evento mutacional mais provável nestes tumores é a inativação de PTEN. Mutações em *TP53* constituem o segundo evento mutacional mais frequente seguido por perda de heterozigossidade de *BRCA1*. O estudo também sugeriu que estes resultados teriam importante impacto terapêutico, visto que apenas uma pequena parcela dos casos apresentou perda do alelo selvagem de *BRCA1* como um primeiro evento mutacional. Para o CM relacionado a *BRCA2*, até o momento nenhum

estudo investigou as características moleculares e a evolução clonal destes tumores (Martins et al., 2012).

Capítulo II. Justificativa e objetivos

Os avanços científicos e tecnológicos da genômica revolucionaram não somente as áreas básicas do conhecimento, mas também, de forma translacional, a prática clínica. Estes avanços estão sendo aplicados diretamente nas sessões de aconselhamento genético, permitindo um acompanhamento mais efetivo dos pacientes, testes genéticos mais precisos e rápidos, delineamento de novas estratégias terapêuticas e a proposição de medidas redutoras de risco. Além disso, o surgimento de alguns consórcios internacionais como o TCGA (do inglês, *The Cancer Genome Atlas*) estão contribuindo substancialmente para a identificação de novos *drivers* de câncer e alvos terapêuticos para tipos específicos de neoplasias. Apesar dos avanços, poucos são os estudos que focam, especificamente, naqueles tumores de etiologia hereditária. Como consequência, tratamentos específicos para este subgrupo de pacientes são escassos. Da mesma forma, estudos funcionais que visam elucidar os mecanismos patofisiológicos associados a mutações são realizados apenas para uma parcela pequena das alterações identificadas.

No sul do Brasil, a presença de uma mutação fundadora encontrada em 0.3% da população geral, a mutação R337H, está relacionada a um aumento do risco para uma série de neoplasias do espectro da SLF/LFL. Apesar dos avanços no entendimento de aspectos clínicos em portadores de R337H e outras mutações em *TP53*, pouco se conhece de mecanismos funcionais associados ao efeito destas alterações. Além disso, estudos prévios do nosso e de outros grupos de pesquisa apontam para alterações bioenergéticas em pacientes com LFS/LFL, sendo que alguns autores sugerem que o uso de substâncias antioxidantes potencialmente teriam um efeito na profilaxia do câncer nesta síndrome.

Já em relação ao câncer de mama associado aos genes *BRCA1* e *BRCA2*, alguns estudos prévios demonstraram que uma parcela destes tumores pode não apresentar perda somática do alelo selvagem de *BRCA1* no tumor e, em outros casos, essa inativação pode ser subclonal. Visto que inativação completa de *BRCA1* ou *BRCA2* (dois eventos mutacionais) é necessária para deficiência completa do processo de reparo de DNA por RH e, conseqüentemente, resposta ao tratamento com inibidores de PARP e platinas, a identificação da frequência

destas alterações torna-se fundamental para predição de resposta terapêutica destes tumores. Além disso, estudos avaliando a composição genômica e grau de heterogeneidade intratumoral ainda são escassos para o câncer de mama hereditário associado aos genes *BRCA1* e *BRCA2*.

Sendo assim, objetivo geral desta tese foi investigar diferentes aspectos genéticos/genômicos, funcionais e clínicos relacionados a mutações germinativas nos genes *TP53*, *BRCA1* e *BRCA2*. O conteúdo apresentado aqui teve como foco de pesquisa duas síndromes hereditárias de predisposição ao câncer distintas, cada qual com seus objetivos específicos descritos a seguir:

Estudo da Síndrome de Li-Fraumeni (Capítulos III-VI)

- Investigar o papel de uma variante genética na região 3'UTR do gene *TP53* em famílias com critérios clínicos para SLF/LFL;
- Estudar o papel de alguns polimorfismos genéticos sobre a heterogeneidade das manifestações clínicas encontradas em portadores da mutação R337H;
- Estudar o perfil metabólico e de resposta a dano de DNA em fibroblastos primários de pacientes portadores da mutação R337H e clássicas no gene *TP53*;
- Avaliar o perfil de dano de DNA e de citocinas pro e anti-inflamatórias em plasma de pacientes portadores da mutação *TP53* R337H e controles saudáveis;
- Estudar o efeito da suplementação com substâncias antioxidantes sobre o fenótipo bioquímico de estresse oxidativo em pacientes portadores da mutação *TP53* R337H.

Estudo do câncer de mama hereditário associado aos genes *BRCA1* e *BRCA2* (Capítulos VII e VIII)

- Revisar aspectos clínico-histopatológicos bem como genéticos e funcionais do câncer de mama hereditário associado aos genes *BRCA1*, *BRCA2* e *PALB2*;

- Caracterizar o perfil mutacional, de variação no número de cópias e estabelecer a frequência clonal dos eventos somáticos em tumores de mama associados a mutações germinativas nos genes *BRCA1* e *BRCA2*;

O trabalho desenvolvido durante o período de doutorado apresentado nesta tese resultou em seis artigos científicos, sendo que quatro deles foram desenvolvidos no Brasil, e focados em diferentes aspectos da Síndrome de Li-Fraumeni (capítulos III-VI). Os outros dois artigos, sendo um de revisão e o outro original, foram elaborados durante o período de doutorado sanduíche no *Memorial Sloan Kettering Cancer Center* em Nova Iorque, e estão relacionados a análise genômica do câncer de mama hereditário associado aos genes *BRCA1* e *BRCA2* (capítulos VII e VIII).

Capítulo III. Rare germline variant (rs78378222) in the TP53 3' UTR: Evidence for a new mechanism of cancer predisposition in Li-Fraumeni syndrome.

Artigo publicado no periódico *Cancer Genetics* em 2016.



ELSEVIER

Cancer Genetics ■■■ (2016) ■■■■■

**Cancer
Genetics**

ORIGINAL ARTICLE

Rare germline variant (rs78378222) in the *TP53* 3' UTR: Evidence for a new mechanism of cancer predisposition in Li-Fraumeni syndrome

Gabriel S. Macedo ^{a,b,1,*}, Igor Araujo Vieira ^{a,b,1}, Ana Paula Brandalize ^b,
Juliana Giacomazzi ^{b,d}, Edenir Inez Palmero ^e, Sahlua Volc ^e,
Vanessa Rodrigues Paixão-Côrtes ^f, Maira Caleffi ^g, Michele Silva Alves ^h,
Maria Isabel Achatz ⁱ, Pierre Hainaut ^j, Patricia Ashton-Prolla ^{a,b,c,k}

^a Post-Graduate Program in Genetics and Molecular Biology, Universidade Federal do Rio Grande do Sul (UFRGS), Porto Alegre, 15053, Rio Grande do Sul, Brazil; ^b Genomic Medicine Laboratory, Experimental Research Center, Hospital de Clínicas de Porto Alegre (HCPA), Porto Alegre, 1247, Rio Grande do Sul, Brazil; ^c Department of Genetics, UFRGS, Porto Alegre, 15053, Rio Grande do Sul, Brazil; ^d Hospital Tacchini, Bento Gonçalves, Rio Grande do Sul, Brazil; ^e Molecular Oncology Research Center, Hospital do Câncer de Barretos, Barretos, 65009, São Paulo, Brazil; ^f Biology Department, Universidade Federal da Bahia, Salvador, 2600, Bahia, Brazil; ^g Hospital Moinhos de Vento, Porto Alegre, 21254, Rio Grande do Sul, Brazil; ^h Service of Medical Physics and Radioprotection, HCPA, Porto Alegre, 1247, Rio Grande do Sul, Brazil; ⁱ Oncogenetics Department, International Research Center, AC Camargo Cancer Center, National Institute of Oncogenomics, São Paulo, 01508-010, São Paulo, Brazil; ^j Institut Albert Bonniot- INSERM 823, University Grenoble-Alpes, Grenoble, France; ^k Medical Genetics Service, HCPA, Porto Alegre, 1247, Rio Grande do Sul, Brazil

Germline mutations in *TP53* are the underlying defects in Li-Fraumeni syndrome (LFS) and its variant, Li-Fraumeni-like (LFL) Syndrome, autosomal dominant disorders that are characterized by predisposition to multiple early onset cancers. Here, we identified rs78378222 (A > C), a rare variant that is located in the 3' untranslated region (3' UTR) of *TP53*, in 7 probands (5.4%) of a cohort from LFS/LFL patients without *TP53* germline mutations in the coding regions. To support its association with the LFS/LFL phenotype, we assessed p53 expression in tumor specimens and fibroblasts from rs78378222[C] carriers. Additionally, we investigated using *in silico* tools the evolutionary conservation and whether rs78378222[C] affects microRNA (miRNA) binding sites in the 3' UTR of *TP53* mRNA. We found lower p53 protein levels in biological samples from rs78378222[C] carriers. Additionally, we showed that rs78378222[C] could interfere with a putative target site of miR-545-3p, a novel miRNA that is predicted to directly target the 3' UTR *TP53*. To our knowledge, this is the first description of rs78378222[C] in LFS/LFL patients. Moreover, these findings suggest that rs78378222[C] lead to haploinsufficiency of p53, a new mechanism of carcinogenesis in LFS/LFL.

Keywords 3' UTR, Li-Fraumeni syndrome, haploinsufficiency, rs78378222

© 2015 Elsevier Inc. All rights reserved.

Introduction

The tumor suppressor protein p53, which is encoded by the *TP53* gene, has been recognized for over two decades to be a key player in both sporadic and inherited cancers. p53 is a critical regulator that protects cells against genomic instability. Acting as a transcriptional factor, p53 induces the expression of genes that are involved in cell cycle arrest, apoptosis,

Received June 27, 2015; received in revised form December 10, 2015; accepted December 29, 2015.

* Corresponding author.

E-mail address: gmacedoufrgs@gmail.com

¹ Co-first authors.

2210-7762/\$ - see front matter © 2015 Elsevier Inc. All rights reserved.
<http://dx.doi.org/10.1016/j.cancergen.2015.12.012>

senescence, inhibition of angiogenesis and metabolism (1,2). Tumor-associated (somatic) *TP53* mutations are present in more than 50% of tumor types and are consistently associated with poor prognosis (3). In contrast, germline *TP53* mutations are the underlying defects in most patients with Li-Fraumeni (LFS) and Li-Fraumeni-like (LFL) Syndromes, both autosomal dominant disorders that are characterized by increased predisposition to a wide spectrum of early onset cancers (4,5). *TP53* mutations have been detected in 77% of LFS and 40% of LFL families (6), and most of these mutations are missense mutations that are located from exons 5–8, corresponding to the DNA-binding domain (DBD) of p53 (3,7).

In 2011, a GWAS study identified a rare new sequence variant in the 3' UTR of the *TP53* gene. This variant, rs78378222 (A > C), was found to be strongly associated with skin basal cell carcinoma (OR = 2.16, $P = 2.2 \times 10^{-20}$). At a frequency of 0.0192 in the Icelandic population, this rare variant changes the highly conserved polyadenylation signal (PAS) sequence (AATAAA to AATACA), leading to impaired 3'-end processing of the *TP53* transcript (8). In addition to directly modifying a highly conserved region of this gene, Li et al. showed that the presence of the rs78378222[C] allele dramatically lowers *TP53* mRNA levels and results in reduced p53 expression and cellular apoptosis (9). Further studies revealed the association of the rs78378222[C] allele with other types of cancer, including some of the tumors that are described in LFS/LFL families, such as central nervous system (CNS) tumors and prostate cancer but not breast cancer (BC) (8,10–13).

In this study, we aimed to determine the prevalence of rs78378222[C] in a cohort of LFS/LFL families from southern and southeastern Brazil, as well as its possible association with hereditary and/or sporadic BC in the same population. Given the observed association of the rs78378222[C] with tumors of the LFS/LFL phenotype, we aimed to further characterize p53 expression in tumor specimens and normal fibroblasts from rs78378222[C] carriers compared to wild-type (WT) controls or carriers of germline *TP53* mutations. Because miRNA target sites (miRTS) are mainly located in the 3' UTR of mRNAs and germline variants in these target sequences may significantly impact gene expression by abolishing, weakening or creating miRTS (14–16), we also investigated the potential effects of rs78378222[C] on miRTS in the *TP53* 3' UTR.

Materials and methods

Study groups and ethical aspects

In this study, 512 women were recruited from southern and southeastern Brazil, including 299 breast cancer-unaffected women from the general population and 213 BC-affected patients who were further classified in three subgroups (Table 1). The first subgroup (“high risk group”) included women with a positive family history of BC and other tumors and whose pedigrees met criteria for HBOC, Hereditary Breast and Ovarian Cancer, or HBCC, Hereditary Breast and Colon Cancer (17,18), and did not meet the criteria for LFS/LFL. The second subgroup (“intermediate risk”) included women with BC and a family history of breast and other cancers not fulfilling criteria for any

Table 1 Study groups and ages at cancer diagnosis (cases) or recruitment (no cancer-affected LFS/LFL patients and controls)

Characteristics	Study groups			Average risk	TP53-germline-mutation carrier		Controls	
	Breast cancer-affected women* (n = 213)	LFS/LFL patients (n = 259)			Cancer-affected	No cancer		Non-carrier (all cancer-affected)
		High risk	Intermediate risk					
Number of patients, n (%)	98 (46)	25 (11.7)	67 (25.9)	90 (42.3)	63 (24.3)	129 (49.8)	299	
Age at diagnosis/recruitment (y)	47.0 (11.9)	42 (8.7)	24.7 (20.7)	58.1 (6.9)	33.1 (16.0)	29.9 (20.1)	52.5 (6.9)	
Mean (±SD)								
Median	45.0	43.0	27.5	56.5	33.5	31	52.0	

* Subgroups of breast cancer (BC) cases: (a) High risk: women whose family history met criteria for HBOC (Hereditary Breast and Ovarian Cancer) and/or HBCC (Hereditary Breast and Colon Cancer), excluding the LFS/LFL phenotype; (b) Intermediate risk: family history of breast and other cancers not fulfilling criteria for any of the known breast cancer predisposition syndromes, including BC cases that were diagnosed before the age of 50 years; (c) Average risk: sporadic BC (age at diagnosis >50 years) and no family history of cancer.

of the known BC predisposition syndromes. The third subgroup ("average risk") included women who were diagnosed with sporadic BC. The patients in this group were diagnosed with BC after the age of 50 years and had no family history of cancer. The control group was composed of women with no clinical evidence and/or suspicion of BC, and their family histories were not consistent with hereditary BC syndromes. Furthermore, the individuals who were included in this group reported normal (BIRADS 1 or 2) mammography results within the last 12 months prior to sample collection.

An additional group of 259 probands from LFS/LFL families with ($n = 130$) and without ($n = 129$) identifiable *TP53* germline mutations was included in this study (Table 1). The LFS/LFL phenotype was defined by the classic (19), Birch, Chompret and Eeles criteria (4,20–24). Mutation testing was performed using Sanger sequencing of the entire coding region (exons 2–11) of *TP53* according to standard protocols (25). The family histories of all of the study subjects were recorded in detailed pedigrees that included a minimum of three generations. This study was approved by the institutional research and ethics committees of the coordinating center (protocols # 08–080, 08–022, 08–023 and 100405) and by the National Brazilian Research Ethics Commission (CONEP; protocol # 14821). The individuals who were recruited for this study provided written informed consent and authorized the publication of their pedigrees.

Genotyping

Peripheral blood samples were collected in EDTA vials, and DNA was isolated using the GE extraction kit (GE Healthcare Life Sciences, BR). *TP53* rs7837822 genotyping was performed in duplicate by real-time PCR using allele-specific TaqMan® probes (Life Tech. Inc., USA, reference number AHHS2U2, PN4331349). Briefly, each reaction contained 20 ng of genomic DNA, 6.25 μ l of 2 \times Master Mix Genotyping TaqMan (Applied Biosystems Inc.), 0.31 μ l of probes that were specific for each allele (40 \times) and 4.94 μ l of DNase-free water. A StepOne PCR Real-Time System was used for every experiment, with an initial cycle of 10 minutes at 95°C, followed by 45 cycles of 15 seconds at 92°C and one minute at 60°C. The genotype of the rs7837822[C] carriers was confirmed using Sanger sequencing; details of the primers that were used are available on request.

p53 expression analyses

A set of formalin-fixed, paraffin-embedded (FFPE) tumor/metastatic tissue specimens from cancer-affected probands of LFS/LFL families was available for study. The samples were divided into (a) derived from LFS/LFL probands with germline-coding *TP53* mutations and not carrying rs7837822[C] and (b) LFL rs7837822[C]-positive patients without identifiable germline *TP53* mutations. p53 immunohistochemistry (IHC) staining was performed according to conventional methods. Briefly, a blockade of nonspecific background staining using the Protein Block reagent (Spring Bioscience Inc., USA) was followed by incubation overnight at 4 °C with a monoclonal anti-p53 antibody (1:200 dilution, DO-7; Dako Corp., Denmark). The primary antibody was detected via the application of the streptavidin-biotin-peroxidase complex (Polyvalent HRP

Plus Kit, Spring Bioscience) and visualized with 3,3'-diaminobenzidine (DAB Substrate System, Spring Bioscience) according to the manufacturer's protocol. Counter staining was performed with Harris hematoxylin. Breast tumor sections with known high p53 expression were used as positive controls, and a tumor section that was stained without the primary antibody was used as a negative control.

Primary fibroblast cultures were grown in a humidified incubator at 5% CO₂ and 37 °C and maintained in DMEM medium that was prepared with 1% penicillin/streptomycin and supplemented with 20% fetal bovine serum (all of the reagents were from Gibco Laboratories, USA). Cultured cell flasks from each patient with distinct *TP53* genotypes either were exposed to ionizing radiation (treated cells) at a dose of 1 Gy or not irradiated (untreated controls). Treated and untreated fibroblasts were collected and lysed 20 h after DNA damage induction and prepared for western blotting as previously described with minor modifications (26). A total of 15 μ g of protein was separated by SDS-PAGE and electroblotted to PVDF membranes, which were incubated overnight at 4 °C with primary antibody against p53 (1:500; DO-1; Santa Cruz Biotechnology, CA), followed by incubation with anti-mouse horseradish peroxidase-conjugated secondary antibody (1:4000; GE Healthcare Life Sciences) for 2 h at 4 °C. β -actin was used as an endogenous control, and the band density was analyzed using the ImageJ software.

Bioinformatic analysis

The evolutionary conservation of the *TP53* polyadenylation signal was analyzed with tools that were available from the USCS Genome Browser (27). Several *in silico* algorithms (Table S1) were used to investigate whether SNP rs7837822 alters and/or creates any miRTS in the *TP53* 3' UTR (28–34). Most of them require a stringent base complementarity between the miRNA seed sequence (nucleotides 2–8 at the miRNA 5' end) and its miRTS in the mRNA 3' UTR, which is often sufficient for functional binding specificity (16,30,35). The miRNA sequences were obtained from the miRBase database release 21 (<http://mirbase.org/>) and the *TP53* 3' UTR sequence corresponding to the NM_000546 was used as a WT reference.

Statistical analysis

Differences in the genotype/allele distribution of SNP rs7837822 A > C between groups were evaluated using χ^2 -analysis, which was also used to test for Hardy–Weinberg equilibrium. A *P*-value < 0.05 was considered statistically significant. SPSS V.18.0 (SPSS Inc., Chicago, IL) was used for data handling and for all of the analyses.

Results

rs78378222 frequency in BC cases and controls

The study groups are detailed in Table 1. In the high-risk group, most of the patients fulfilled the HBOC criteria. In the intermediate-risk group, a significant proportion (32.0%) had at least one BC-affected relative, and most patients (64.0%)

Table 2 rs78378222 (A > C) genotyping results

Genotype	Breast cancer-affected women			LFS/LFL patients			P
	High risk	Intermediate Risk	Average risk	TP53-germline-mutation carrier	Non-carrier	Controls	
	No. (%)	No. (%)	No. (%)	No. (%)	No. (%)	No. (%)	
	n = 98	n = 25	n = 90	n = 130	n = 129	n = 299	
AA	98 (100)	25 (100)	90 (100)	130 (100)	122 (94.6)	296 (99.0)	
AC	0	0	0	0*	7 (5.4)*, ^a	3 (1.0)*, ^a	0.002*
CC	0	0	0	0	0	0	
C allele frequency	0	0	0	0	0.027	0.005	

* Comparison between LFS/LFL subgroups with and without germline TP53 mutations and controls (Fisher exact test).

^a Comparison between LFS/LFL patients without pathogenic germline TP53 mutations and controls: $P = 0.015$ (Yates's continuity correction).

were diagnosed with BC before the age 50 years. In the average-risk group, all women were diagnosed with BC after the age of 50 years and had no family history of cancer (Table S2).

The rs78378222 genotyping results are summarized in Table 2. We did not identify an association between the presence of the rs78378222[C] allele and BC risk. The risk allele was not identified among the BC patients in this series

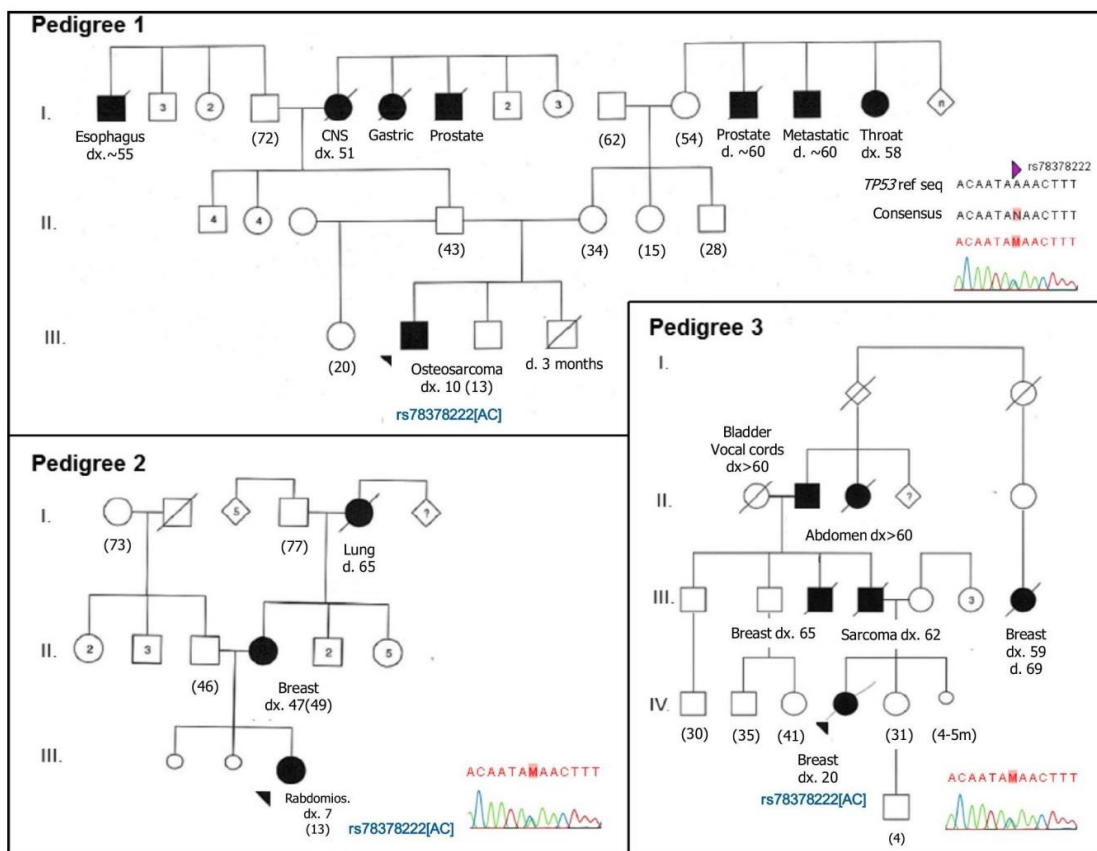

Figure 1 Pedigrees of the rs78378222[C] carriers LFL patients without identifiable germline TP53 mutations. p53 expression was analyzed in tumor/metastatic specimens from probands of the pedigrees 1–3 and primary cultured fibroblasts obtained from proband 4. Arrows indicate the proband. Cancer-affected relatives are represented by blackened symbols. Dx indicates age at diagnosis; (n) indicates current age; d, death age; CNS, central nervous system.

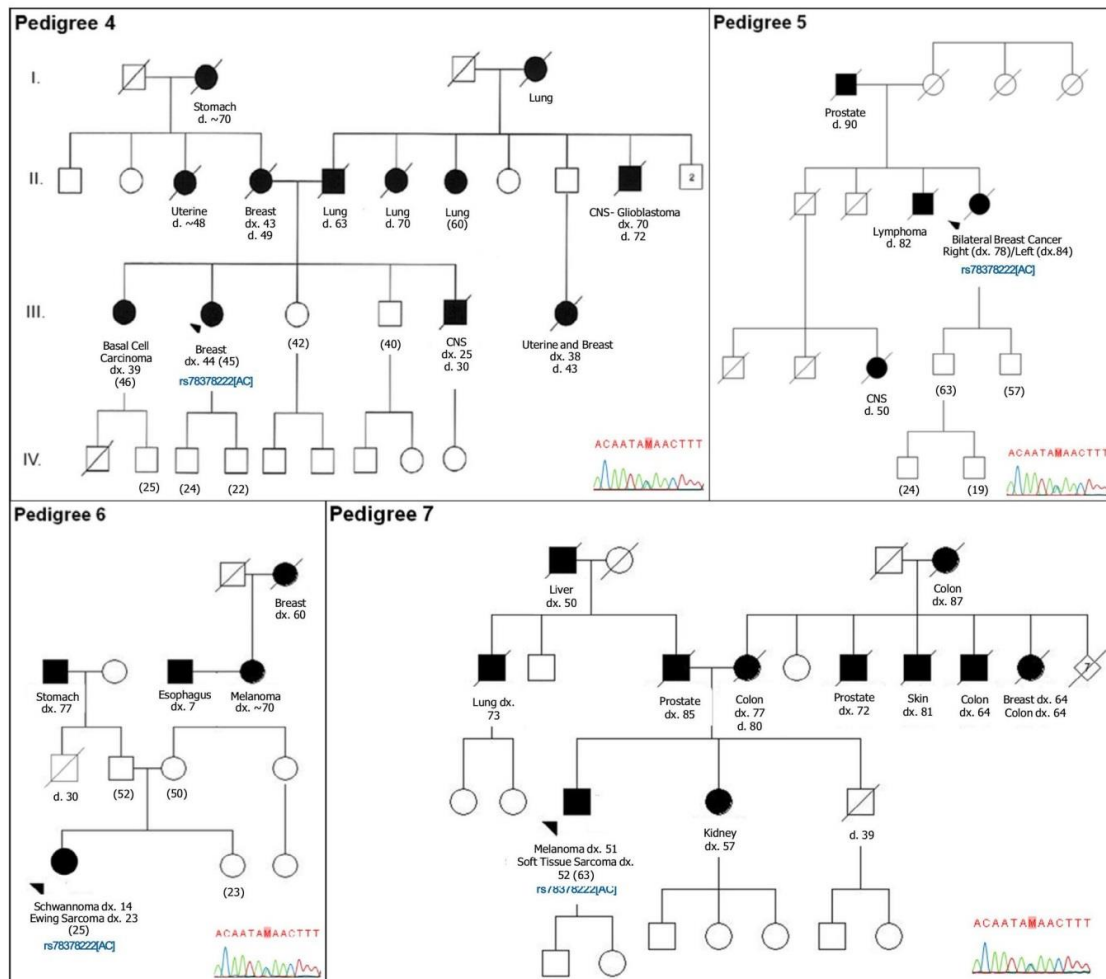

Figure 1 (continued)

(excluding LFS/LFL phenotype). However, risk allele was found in 3 individuals of the control group with a family history of cancer (pedigrees in Figure S1). The genotypic frequencies in all of the groups were in Hardy–Weinberg equilibrium.

rs78378222 frequency in the LFS/LFL probands

Among the 130 LFS/LFL patients with germline *TP53* mutations included in this study, 120 (92.31%) were carriers of the founder *TP53* p.R337H mutation, and 9 (6.92%) were carriers of a *TP53* DBD mutation (Table S3). The rs7837822[C] allele was not identified in any of the individuals carrying germline *TP53* mutations but was present in 7 of the 129 LFS/LFL probands without coding *TP53* mutations (Table 2 and Figure S2). The variant frequency was significantly different in this group of probands compared to that observed in the control group ($P = 0.015$) (Table 2). The genotypic frequencies in the LFS/LFL groups were in Hardy–Weinberg

equilibrium. Pedigrees of the rs7837822[C] carriers are shown in Figure 1. All 7 of the probands carrying the 3' UTR variant were affected by cancer and had familial histories that were consistent with LFL phenotype (one family fulfilling Eeles 1, two families fulfilling Eeles 2 criteria and the other four Chompret criteria).

p53 expression in LFL rs78378222[C] carriers

We assessed p53 expression using IHC in primary and/or metastatic tumor specimens from two groups of patients: (a) LFL patients carrying rs7837822[C] and (b) LFS/LFL probands with known pathogenic germline *TP53* mutations. The clinical features and sample characteristics are shown in Table S4. In group (a), the primary tumor specimen of only one rs7837822[C] carrier was available (Figure 2 A1), whereas for the remaining patients, metastatic tissue samples were obtained (Figure 2 A2, A3). In this group, we observed weak and

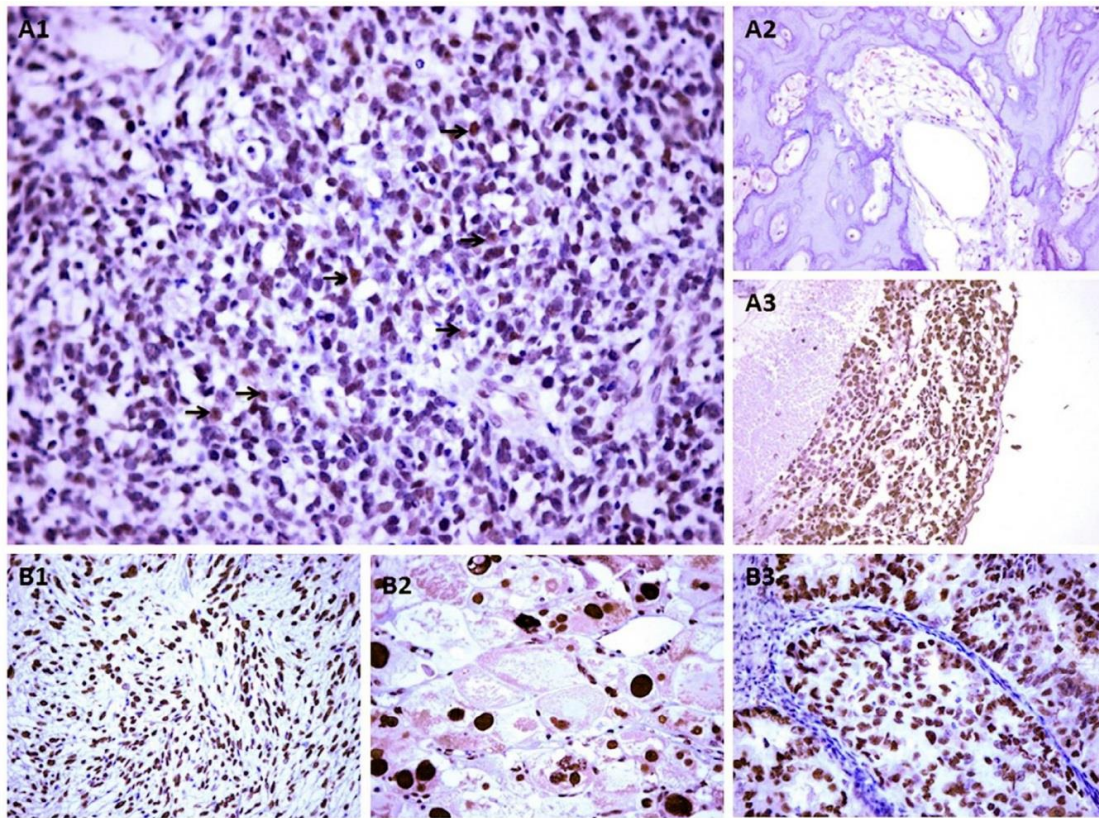

Figure 2 Immunohistochemical analysis of p53 expression in primary tumor and metastatic tissue sections from LFS/LFL patients with different *TP53* germline alterations. (A1, A2, A3) Specimens of rs78378222[C] carriers without coding region *TP53* germline mutations: rhabdomyosarcoma section with arrows showing cells positive for p53 (A1); lung section (metastasis of osteosarcoma) (A2); and pleura biopsy (metastasis of breast cancer) (A3). (B1, B2) Samples from carriers of coding germline *TP53* mutations: sarcoma section from a p.R273H mutation carrier (B1); and section of adrenocortical carcinoma from a p.R337H mutation carrier (B2). Positive control (breast tumor section) is also shown (B3). p53 is seen as brown particles and is located both in cytoplasm and nucleus. All magnifications $\times 400$.

focal p53 immunostaining regardless of specimen origin. In contrast, in group (b), comprising samples from probands with known pathogenic germline *TP53* mutations, the tumors showed an intense nuclear accumulation of p53 (Figure 2 B1, B2).

In addition, we also found lower p53 protein levels in fibroblasts harboring the rs78378222[C] allele compared to fibroblasts with WT *TP53* under both non-irradiated conditions and 20 hours after radiation-induced DNA damage (Figure 3). The p53 protein levels of fibroblasts harboring the rs78378222[C] allele were similar to that found in p.R337H/WT, but lower when compared to p.R337H/p.R337H and p.R273H/WT mutants. These data indicate that the rs78378222 variant hinders p53 expression at the baseline and after exposure to cellular stress.

Evolutionary conservation

We retrieved the sequence of the *TP53* polyadenylation signal (AAUAAA) for all 63 therian mammals, including three *Homo*

species: sequences that were derived from the human genome assembly NCBI Build 37/hg19 and from Neanderthal and Denisova specimens (data not shown in the Figure 4). None of these organisms presented any variation in the locus of the variant rs78378222 (1175 A > C, Chromosome 17:7571752) (Figure 4 and Figure S3).

Prediction of miRTS around rs78378222 in the *TP53* 3' UTR

Computational tools indicated that the rs78378222 variant is located in a putative miRTS. Although the SNP is not exactly located in a predicted seed match, it lies within a site at which there is perfect base complementarity between the human *TP53* 3' UTR and the 3' end of hsa-miR-545-3p (Figure S4 and Table S5), a miRNA not reported previously to target the human *TP53* gene (9,36,37). According to RNAhybrid and PITA, the WT *TP53* 3'UTR seemed more favorable for the binding of miR-545-3p, evidenced by a lower (more

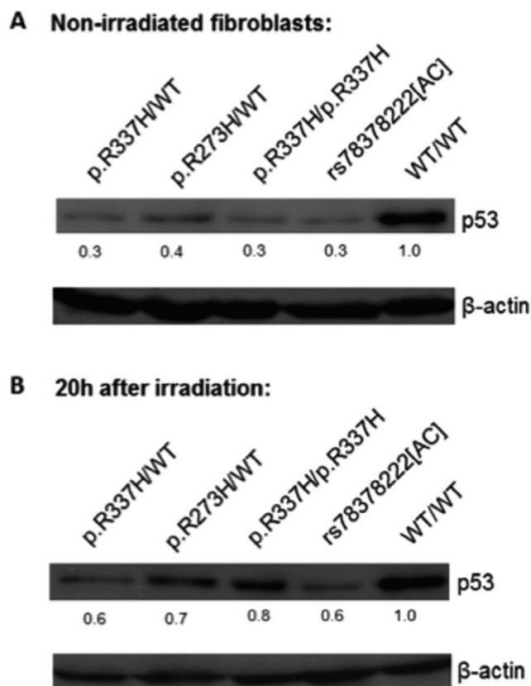

Figure 3 Western blot of p53 expression in non-irradiated fibroblasts (A) and fibroblasts 20 hours after irradiation (B) from rs78378222[C] carrier with the LFL phenotype compared to a p.R337H/WT, p.R273H/WT, p.R337H/p.R337H mutants and control individual (WT/WT). β -actin was used as a control. The band intensity of p53 in relation to the control individual is indicated. WT, wild-type allele.

negative) minimum free energy for hybridization and lower $\Delta\Delta G$ scores compared to “variant 3’ UTR” containing rs78378222[C] (Figure S5). All miRNAs predicted to target the WT and variant 3’ UTR were the same, suggesting that rs78378222[C] does not create a new *TP53* miRTS (Table S6). Taken together, these data suggest that the binding of miR-545-3p to the putative *TP53* miRTS could be weakened by rs78378222[C].

Discussion

In this study, we hypothesized and attempted to confirm that the *TP53* rs78378222[C] variant could be directly associated with LFS/LFL. Initially, we assessed the variant prevalence in four distinct cohorts: population controls, non-LFS/LFL BC-affected women, and LFS/LFL families with and without germline *TP53* mutations. The variant was not identified in BC-affected women from different risk categories. These findings agree with the study of Stacey et al., who assessed rs78378222[C] prevalence in a large series of BC patients and did not find an association between the variant and disease (8). However, when analyzing probands with the LFS/LFL phenotype, although rs78378222[C] was not identified in individuals

harboring a germline *TP53* mutation, it was encountered in probands without identifiable coding *TP53* mutations. Finally, rs78378222[C] was also encountered at a lower frequency, in cancer-unaffected individuals (control group). A careful review of the pedigrees from two of the three controls showed that although these controls did not meet any LFS/LFL criteria, they had relatives with CNS tumors and BC. We had no access to the pedigree of the third family.

Germline mutations in the coding region of *TP53* are the only known genetic defects underlying LFS/LFL. Currently, molecular diagnosis consists of mutation screening in the coding (exons 2–11) and flanking intronic regions by gene sequencing, as well as gene rearrangement analysis using MLPA or equivalent methods. Usually, the *TP53* germline alterations that are associated with these syndromes are missense mutations that cluster in highly conserved regions of the DBD (38). Here, we identified rs78378222[C] at a high frequency (5.4%) in a cohort of LFS/LFL patients without coding *TP53* mutations. All 7 of the probands carrying the 3’ UTR variant were affected by cancer and had familial histories that were consistent with LFL phenotype (one family fulfilling Eeles 1, two families fulfilling Eeles 2 criteria and the other four Chompret criteria). The tumors that were found in these families, such as osteosarcomas, rhabdomyosarcomas, brain tumors and BC, are typical of the syndrome phenotype. Although rs78378222[C] was previously associated with certain tumor types that belong to the SLF/LFL spectrum (8,11–13), this is the first description of rs78378222[C] in association with LFS/LFL.

We then assessed the functional implications of *TP53* rs78378222[C]. Previously, Stacey et al. (2011) demonstrated that rs78378222[A/C] heterozygotes expressed “somewhat lower” *TP53* transcript levels than WT homozygotes ($P = 0.041$) and that correctly terminated polyA(+) mRNAs were produced predominantly (73%) from the WT allele in peripheral blood specimens and adipose tissue ($P = 1.6 \times 10^{-6}$) (8). This latter finding was also reported in samples from two rs78378222 heterozygous primary neuroblastomas (12). Because the 3’ UTR variant occurs in the PAS sequence of *TP53*, none of the downstream p53 protein modifications are expected to be affected. In this study, although limited by sample size and tumor tissue availability, we identified a distinct profile of p53 immunostaining in rs78378222[C] samples (weak and focal signal) compared to that in tumors from coding-*TP53*-mutation carriers (i.e., p.R337H and p.R273H), which were characterized by nuclear accumulation of p53. In agreement with the analysis of the tumors, the assessment of protein expression in the fibroblasts that were submitted to radiation-induced DNA damage showed that rs78378222[C] carrier cells maintained lower p53 protein levels than those of the p.R337H/p.R337H, p.R273H/WT mutants and *TP53* WT cells. We assume that this observation could be due to the faster depletion of *TP53* transcripts harboring rs78378222[C], which has impaired polyadenylation. These findings confirm a previous report of *in vitro* analyses involving p53-null cells that were transfected with exogenous p53 constructs containing the rs78378222[C] allele (9).

An analysis of the evolutionary conservation of the *TP53* PAS sequence (AAUAAA) through of all 63 of the therian mammals also corroborates a functional impact of the variant. The *TP53* PAS sequence is identical, supporting findings from more than 30 years ago that the hexanucleotide AAUAAA

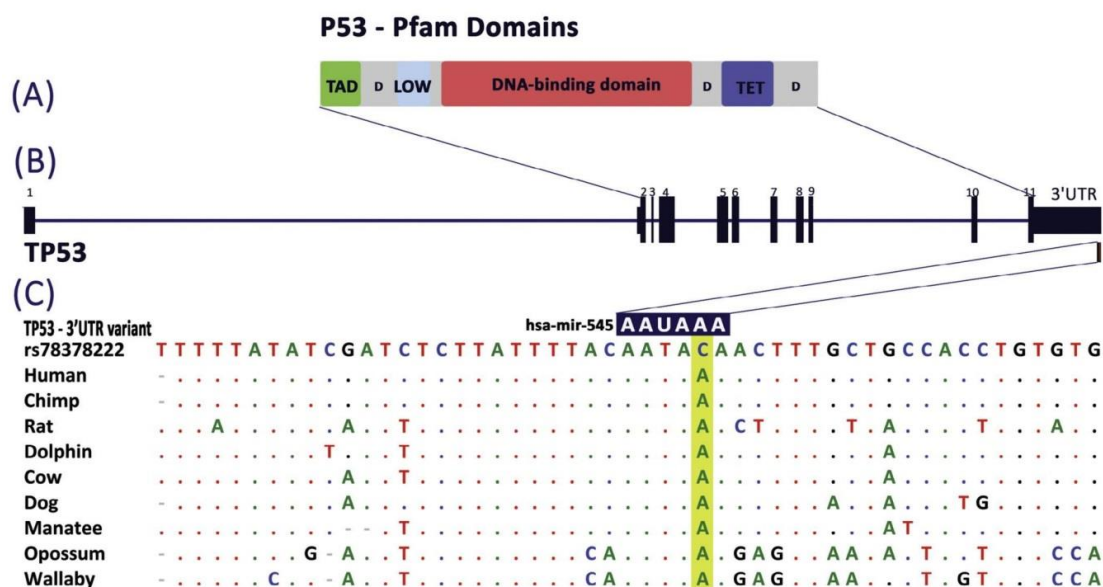

Figure 4 *TP53* gene structure and protein domains showing a sequence alignment of human and a few other species highlighting the rs78378222 and nucleotides up and downstream of the variant.

is highly conserved in eukaryotic mRNAs (39–42). In agreement with this observation, a recent study suggests that the PAS is under purifying selection in mammals (43). Based on outputs from computational algorithms, we observed the prediction of miR-545-3p (also referred simply as miR-545) as a possible novel miRNA to directly target the *TP53* 3' UTR and that its putative miRTS in this 3' UTR sequence encompasses the rs78378222 position. In addition, energetic scores that were computed using RNAhybrid and PITA algorithms suggested that rs78378222[C] could weaken the binding of this candidate miRNA to its putative *TP53* miRTS, but it seems not to create a new miRTS in this transcript. These *in silico* predictions do not explain the reduced *TP53* mRNA levels detected in rs78378222[C] carriers but suggest a new aspect associated with this variant that needs to be experimentally elucidated.

Ultimately, several lines of evidence support the hypothesis that rs78378222 may be the molecular alteration that is responsible for the LFL phenotype. First, many of the tumors that were identified in the 7 variant-positive families are characteristic of the syndrome. Second, previously published data (8,9) along with those presented here demonstrate that rs78378222 is a functional variant that impairs the proper termination and polyadenylation of the *TP53* transcript, resulting in reduced p53 expression. Third, the rs78378222[C] allele does not seem to co-segregate with other germline pathogenic *TP53* mutation because it was not present in any mutation carrier and was only encountered in mutation-negative probands. Fourth, the polyadenylation signal sequence within which the variant occurs, the hexanucleotide AAUAAA, is located 10–30 bases upstream of the cleavage/

polyadenylation site and is present in 90% of all polyadenylation elements known to date, being recognized as one of the most highly conserved sequence elements (44,45).

In summary, our findings suggest a new mechanism by which *TP53* promotes cancer predisposition and that is likely related to a reduction in *TP53* dosage (haploinsufficiency). Our findings also highlight the need for a more comprehensive analysis of the *TP53* gene in the molecular diagnosis routine, including this gene and the remaining regulatory gene regions. However, further functional characterization studies and an analysis of larger series of families with the LFS/LFL phenotype should be undertaken to confirm rs78378222[C] to be a pathogenic variant that is associated with this disorder.

Conflict of interest

The authors declare no conflict of interest.

Acknowledgments

We are grateful to Bárbara B. Alemar, Clévia Rosset and Cristina Brinckmann Netto for their valuable contributions and support. The authors also wish to thank Flávia Giusti and Rafael Bringhenti from Unidade de Patologia Experimental, Centro de Pesquisa Experimental—HCPA, for their help with technical procedures and for the interpretation of the IHC analyses. This work was supported by fellowships from Conselho Nacional de Desenvolvimento Científico e Tecnológico (CNPQ) and Coordenação de Aperfeiçoamento de Pessoal de Nível

Superior (CAPES) and funded in part by Fundação de Amparo à Pesquisa do Estado do Rio Grande do Sul (FAPERGS-PPSUS) (grant # 09/0103-0), FAPERGS-PRONEX (Grant #10/0051-9), Fundo de Incentivo à Pesquisa do Hospital de Clínicas de Porto Alegre (FIPE-HCPA) and CNPQ (Grant #478430/2012-4).

Supplementary data

Supplementary data related to this article can be found online at doi:10.1016/j.cancergen.2015.12.012.

References

- Levine AJ. p53, the cellular gatekeeper for growth and division. *Cell* 1997;88:323–331.
- Vogelstein B, Lane D, Levine AJ. Surfing the p53 network. *Nature* 2000;408:307–310.
- Petitjean A, Mathe E, Kato S, et al. Impact of mutant p53 functional properties on TP53 mutation patterns and tumor phenotype: lessons from recent developments in the IARC TP53 database. *Hum Mutat* 2007;28:622–629.
- Li FP, Fraumeni JF, Mulvihill JJ, et al. A cancer family syndrome in twenty-four kindreds. *Cancer Res* 1988;48:5358–5362.
- Malkin D, Li FP, Strong LC, et al. Germ line p53 mutations in a familial syndrome of breast cancer, sarcomas, and other neoplasms. *Science* 1990;250:1233–1238.
- Varley JM. Germline TP53 mutations and Li-Fraumeni syndrome. *Hum Mutat* 2003;21:313–320.
- Hainaut P, Hollstein M. p53 and human cancer: the first ten thousand mutations. *Adv Cancer Res* 2000;77:81–137.
- Stacey SN, Sulem P, Jonasdottir A, et al. A germline variant in the TP53 polyadenylation signal confers cancer susceptibility. *Nat Genet* 2011;43:1098–1103.
- Li Y, Gordon MW, Xu-Monette ZY, et al. Single nucleotide variation in the TP53 3' untranslated region in diffuse large B-cell lymphoma treated with rituximab-CHOP: a report from the International DLBCL Rituximab-CHOP Consortium Program. *Blood* 2013;121:4529–4540.
- Zhou L, Yuan Q, Yang M. A functional germline variant in the P53 polyadenylation signal and risk of esophageal squamous cell carcinoma. *Gene* 2012;506:295–297.
- Egan KM, Nabors LB, Olson JJ, et al. Rare TP53 genetic variant associated with glioma risk and outcome. *J Med Genet* 2012;49:420–421.
- Diskin SJ, Capasso M, Diamond M, et al. Rare variants in TP53 and susceptibility to neuroblastoma. *J Natl Cancer Inst* 2014;106:dju047.
- Enciso-Mora V, Hosking FJ, Di Stefano AL, et al. Low penetrance susceptibility to glioma is caused by the TP53 variant rs7837822. *Br J Cancer* 2013;108:2178–2185.
- Endale Ahanda ML, Fritz ER, Estellé J, et al. Prediction of altered 3'-UTR miRNA-binding sites from RNA-Seq data: the swine leukocyte antigen complex (SLA) as a model region. *PLoS ONE* 2012;7:e48607.
- López de Silanes I, Quesada MP, Esteller M. Aberrant regulation of messenger RNA 3'-untranslated region in human cancer. *Cell Oncol* 2007;29:1–17.
- Bartel DP. MicroRNAs: genomics, biogenesis, mechanism, and function. *Cell* 2004;116:281–297.
- Statement of the American Society of Clinical Oncology: genetic testing for cancer susceptibility, adopted on February 20, 1996. *J Clin Oncol* 1996;14:1730–1736; discussion 1737–1740.
- Meijers-Heijboer H, Wijnen J, Vasen H, et al. The CHEK2 1100delC mutation identifies families with a hereditary breast and colorectal cancer phenotype. *Am J Hum Genet* 2003;72:1308–1314.
- Li FP, Fraumeni JF. Soft-tissue sarcomas, breast cancer, and other neoplasms. A familial syndrome? *Ann Intern Med* 1969;71:747–752.
- Birch JM, Hartley AL, Tricker KJ, et al. Prevalence and diversity of constitutional mutations in the p53 gene among 21 Li-Fraumeni families. *Cancer Res* 1994;54:1298–1304.
- Birch JM, Alston RD, McNally RJ, et al. Relative frequency and morphology of cancers in carriers of germline TP53 mutations. *Oncogene* 2001;20:4621–4628.
- Chompret A, Brugières L, Ronsin M, et al. P53 germline mutations in childhood cancers and cancer risk for carrier individuals. *Br J Cancer* 2000;82:1932–1937.
- Chompret A, Abel A, Stoppa-Lyonnet D, et al. Sensitivity and predictive value of criteria for p53 germline mutation screening. *J Med Genet* 2001;38:43–47.
- Eeles RA. Germline mutations in the TP53 gene. *Cancer Surv* 1995;25:101–124.
- IARC, International Agency for Research on Cancer, 2014. Detection of TP53 Mutations by Direct Sequencing. Available at: p53.iarc.fr/download/tp53_directsequencing_iarc.pdf. Accessed 11 August, 2014.
- Zamin LL, Dillenburg-Pilla P, Argenta-Comiran R, et al. Protective effect of resveratrol against oxygen-glucose deprivation in organotypic hippocampal slice cultures: involvement of PI3-K pathway. *Neurobiol Dis* 2006;24:170–182.
- Fujita PA, Rhead B, Zweig AS, et al. The UCSC Genome Browser database: update 2011. *Nucleic Acids Res* 2011;39(Database issue):D876–D882.
- Krüger J, Rehmsmeier M. RNAhybrid: microRNA target prediction easy, fast and flexible. *Nucleic Acids Res* 2006;34(Web Server issue):W451–W454.
- Kertesz M, Iovino N, Unnerstall U, et al. The role of site accessibility in microRNA target recognition. *Nat Genet* 2007;39:1278–1284.
- Friedman RC, Farh KK, Burge CB, et al. Most mammalian mRNAs are conserved targets of microRNAs. *Genome Res* 2009;19:92–105.
- Garcia DM, Baek D, Shin C, et al. Weak seed-pairing stability and high target-site abundance decrease the proficiency of lsy-6 and other microRNAs. *Nat Struct Mol Biol* 2011;18:1139–1146.
- Griffiths-Jones S, Saini HK, van Dongen S, et al. miRBase: tools for microRNA genomics. *Nucleic Acids Res* 2008;36(Database issue):D154–D158.
- Sturm M, Hackenberg M, Langenberger D, et al. TargetSpy: a supervised machine learning approach for microRNA target prediction. *BMC Bioinformatics* 2010;11:292.
- Miranda KC, Huynh T, Tay Y, et al. A pattern-based method for the identification of MicroRNA binding sites and their corresponding heteroduplexes. *Cell* 2006;126:1203–1217.
- Bartel DP. MicroRNAs: target recognition and regulatory functions. *Cell* 2009;136:215–233.
- Hu W, Chan CS, Wu R, et al. Negative regulation of tumor suppressor p53 by microRNA miR-504. *Mol Cell* 2010;38:689–699.
- Hermeking H. MicroRNAs in the p53 network: micromanagement of tumour suppression. *Nat Rev Cancer* 2012;12:613–626.
- Malkin D. Li-fraumeni syndrome. *Genes Cancer* 2011;2:475–484.
- Proudfoot NJ, Brownlee GG. 3' non-coding region sequences in eukaryotic messenger RNA. *Nature* 1976;263:211–214.

40. Wickens M, Stephenson P. Role of the conserved AAUAAA sequence: four AAUAAA point mutants prevent messenger RNA 3' end formation. *Science* 1984;226:1045–1051.
41. Manley JL, Yu H, Ryner L. RNA sequence containing hexanucleotide AAUAAA directs efficient mRNA polyadenylation in vitro. *Mol Cell Biol* 1985;5:373–379.
42. Proudfoot N. Poly(A) signals. *Cell* 1991;64:671–674.
43. Derti A, Garrett-Engle P, Macisaac KD, et al. A quantitative atlas of polyadenylation in five mammals. *Genome Res* 2012;22:1173–1183.
44. Tian B, Hu J, Zhang H, et al. A large-scale analysis of mRNA polyadenylation of human and mouse genes. *Nucleic Acids Res* 2005;33:201–212, [in eng].
45. Lutz CS. Alternative polyadenylation: a twist on mRNA 3' end formation. *ACS Chem Biol* 2008;3:609–617.

Capítulo IV. p53 signaling pathway polymorphisms, cancer risk and tumor phenotype in *TP53* R337H mutation carriers.

Artigo a ser submetido ao periódico *Gene*.

**p53 signaling pathway polymorphisms, cancer risk and tumor phenotype in
TP53 R337H mutation carriers**

Gabriel Macedo^{1,2}, Igor Araujo Vieira^{1,2}, Fernanda Sales Luiz Vianna^{1,2}, Barbara Alemar^{1,2}, Juliana Giacomazzi⁴, Maira Caleffi⁵, Edenir Inez Palmero⁶, Maria Isabel Achatz⁷ and Patricia Ashton-Prolla^{1-3,6}.

AFFILIATIONS

¹ Post-Graduate Program in Genetics and Molecular Biology, Universidade Federal do Rio Grande do Sul (UFRGS), Porto Alegre, 15053, Rio Grande do Sul, Brazil

² Genomic Medicine Laboratory, Experimental Research Center, Hospital de Clínicas de Porto Alegre (HCPA), Porto Alegre, 1247, Rio Grande do Sul, Brazil

³ Department of Genetics, UFRGS, Porto Alegre, 15053, Rio Grande do Sul, Brazil

⁴ Hospital Tacchini, Bento Gonçalves, Rio Grande do Sul, Brazil

⁵ Hospital Moinhos de Vento, Porto Alegre, 21254, Rio Grande do Sul, Brazil

⁶ Molecular Oncology Research Center, Hospital do Câncer de Barretos, Barretos, 65009, São Paulo, Brazil

⁷ Oncogenetics Department, International Research Center, AC Camargo Cancer Center, National Institute of Oncogenomics, São Paulo, 01508-010, São Paulo, Brazil

⁸ Medical Genetics Service, HCPA, Porto Alegre, 1247, Rio Grande do Sul, Brazil

Abstract

Li-Fraumeni and Li-Fraumeni-like syndrome (LFS/LFL) are clinically heterogeneous cancer predisposition syndromes characterized by diagnosis of early-onset and often multiple cancers with variable tumor patterns and incomplete penetrance. To date, the genetic modifiers described in LFS/LFL have been shown to map to either *TP53* or its main negative regulator, *MDM2*. Additionally, all studies were focused on families with different *TP53* germline mutations. Hence, in this study we explored the effect of the most studied polymorphisms of p53 pathway genes on cancer risk, age at first diagnosis and tumor type of individuals carrying the founder *TP53* mutation R337H (n=136) and controls (n=186). Cancer-affected carriers had been diagnosed either with adrenocortical carcinoma (ACC, n=29) or breast cancer (BC, n=43). Allelic discrimination using TaqMan assay was used for genotyping *MDM2* SNP 309 (rs2279744) as well as *MDM4* (rs1563828) and *USP7* (rs1529916) polymorphisms. We found significantly higher *MDM2* SNP 309 GG genotype and G allele frequencies in the LFS cohort than in controls. Furthermore, median age at first diagnosis was earlier in GG carriers (*MDM2* SNP309) when compared to other genotypes for both cancers (ACC: age 1 year vs. 2 years; BC: age 35 years vs. 43 years, respectively), although not statistically different. The allelic and genotypic frequencies for all SNPs did not differ between cancer affected and unaffected carriers, neither between patients with ACC or BC. In conclusion, our results suggest that *MDM2* SNP 309 may contribute to the LFL phenotype and also to an earlier age at diagnosis of ACC and BC cancer in carriers of the R337H founder mutation.

Key words: *TP53*, R337H, Li-Fraumeni Syndrome, genetic modifiers, polymorphisms.

Introduction

Li-Fraumeni Syndrome (LFS) and its variant, Li-Fraumeni-like Syndrome (LFL), are clinically heterogeneous cancer predisposition syndromes characterized by an autosomal dominant inheritance pattern, diagnosis of early-onset cancers and multiple primary tumors. The core tumors of LFS/LFL are bone and soft-tissue sarcomas, central nervous system tumors, breast cancer (BC) and adrenocortical carcinoma (ACC) (Li and Fraumeni, 1969b; Li and Fraumeni, 1969a; Li et al., 1988). Currently, germline mutations in the *TP53* gene are the only known genetic alterations underlying LFS/LFL (Malkin et al., 1990).

In Southern and Southeastern regions of Brazil, a specific mutation in the *TP53* gene, R337H (c.1010G>A, p.ArgR337His), has been reported to occur at a high frequency both at population level and among individuals with clinical criteria for LFS/LFL (Achatz et al., 2007; Palmero et al., 2008; Custódio et al., 2013). Carriers display a wide range of cancers, within and beyond the spectrum of core tumors of the syndrome, but tumor penetrance appears to be lower than that observed in carriers of DNA-binding domain (DBD) mutations (Ribeiro et al., 2001; Achatz et al., 2007; Palmero et al., 2008; Giacomazzi et al., 2013). The Arginine residue at codon 337 is a critical part of an alpha-helix motif involved in the protein oligomerization. Functional data have shown that the replacement of arginine by histidine disrupts the tetramer form in a pH-dependent manner, making the domain unable to oligomerize in conditions of slightly elevated pH (DiGiammarino et al., 2002). Some authors have suggested that this peculiarity could explain, at least in part, the reduced penetrance observed in R337H carriers (Malkin, 2011)

The p53 protein acts as a transcriptional factor that, in response to stress, regulates the expression of an array of different genes involved in growth arrest, DNA repair, apoptosis, metabolism and senescence (Vousden and Prives, 2009). Variations in p53 (multiple protein isoforms and/or mutant proteins) and in their partners are thought to underlie the wide range of clinical manifestations observed in the syndrome both within and between families. For instance, single nucleotide polymorphisms (SNPs) in the *TP53* and *MDM2* genes, a negative regulator of p53, have been associated to earlier age at cancer diagnosis in carriers of *TP53* germline mutations (Bougeard et al., 2006; Marcel et al., 2009).

Although significant progresses have been made in our understanding of the molecular biology of p53 and clinical/epidemiologic features of LFS/LFL, knowledge on risk modifiers and its effect on phenotype are still incomplete. Thus, in the present study we aimed to investigate whether selected SNPs in *MDM2*, *MDM4* and *USP7* were associated with cancer risk, age at first diagnosis and specific tumor types in carriers of the germline *TP53* mutation R337H.

Material and Methods

Subjects

For this study a total of 136 subjects were recruited from families attending Cancer Risk Evaluation clinics in the Hospital de Clinicas de Porto Alegre (Porto Alegre, Brazil), Hospital do Câncer A.C. Camargo (São Paulo, Brazil) and Hospital do Câncer de Barretos (Barretos, São Paulo). The LFL group included cancer-unaffected R337H mutation carriers (n=60); R337H mutation carriers with a previous diagnosis of ACC (n=29); and R337H mutation carriers with a previous diagnosis of BC (n=43). In addition, a control group consisted of cancer-unaffected individuals with no family history of cancer in first or second degree and without the R337H mutation (n=186). Controls were recruited from a community based BC prevention program in Southern Brazil (Caleffi et al., 2009). The institutional ethics committees of participating institutions approved the study and all participants provided written informed consent before recruitment.

Polymorphism analyses

Genomic DNA was extracted from white blood cells or non-tumoral tissue using commercial kits (Illustra Blood genomicPrep Mini Spin Kit, GE Healthcare and DNA FFPE Kit, FFPE Qiagen). Mutation testing was previously performed using Sanger sequencing of the entire coding region (exons 2-11) of *TP53* according to standard protocols (p53.iarc.fr/download/tp53_directsequencing_iarc.pdf).

TaqMan allelic discrimination analyses were performed according to Applied Biosystems standard protocols (Applied Biosystems, Carlsbad, USA). The analyzed SNPs were as follows: *MDM4* rs1563828 (C_9493064_10), *USP7*

rs1529916 (C_9688119_1), and *MDM2* rs2279744 for which a custom-made TaqMan assay was made, using forward primer 5'-CGGGAGTTCAGGGTAAAGGT-3', reverse primer 5'-ACAGGCACCTGCGATCATC-3', VIC probe 5'-CTCCCGCGCCGAAG-3' and FAM probe 5'-TCCCGCGCCGAG-3' (Applied Biosystems). PCR cycling reactions were performed on an ABI StepOne System (Applied Biosystems) and consisted of initial denaturation at 95°C for 15 min, 40 cycles with denaturation 95°C for 15 s, and then annealing and extension at 60°C for 1 min.

Statistical analyses

Descriptive statistics was used to determine allelic and genotypic frequencies. Differences in the genotype distribution and Hardy-Weinberg equilibrium were assessed by chi-square analysis. Comparison of the age at first cancer diagnosis according to polymorphism status was assessed by the non-parametric Kruskal-Wallis and Mann–Whitney tests. A p-value of less than 0.05 was considered statistically significant. SPSS V.18.0 (SPSS Inc., Chicago, IL) was used for data handling and for all analyses.

Results

Clinical characteristics of *TP53* R337H carriers and non-carriers enrolled in the study are shown in **Table 1**. Of the 136 carriers, 60 (44%) were cancer-unaaffected, 29 (21%) had a previous diagnosis of ACC, 43 (32%) of BC and 4 (3%) developed other tumors. As expected, the median age of ACC diagnosis was earlier (2.5 years; InterQuartile Range (IQR) 1.0-6.7) than that found in BC cases (42 years; IQR 36-50). In cancer-unaaffected and controls, the median age at recruitment was 33 (IQR 24-45) and 52 (IQR 47-57), respectively.

The genotypic and allele frequencies of *MDM2*, *MDM4* and *USP7* SNPs among R337H carriers (with and without cancer) and controls are presented in **Table 2**. First, we compared the distribution of genotypes and alleles between all R337H mutation carriers, regardless of personal history of cancer, and non-carriers (control group). The genotypic and allelic distribution between groups did not differ significantly for *MDM4* and *USP7* SNPs. In contrast, *MDM2* SNP309

(T>G) was significantly associated to presence of the mutation for both, allelic ($p=0.014$) and genotypic ($p=0.042$) frequencies.

Second, we analyzed the overall impact of each SNP on cancer risk in the group of R337H mutation carriers, irrespective of the cancer type. No statistically significant differences in the allelic and genotypic frequencies of each SNP were found between R337H carriers with and without cancer, indicating similar frequencies among these groups (**Table 2**). Since the mean age at recruitment of cancer-unaffected R337H mutation carriers was earlier than that found in the BC group, meaning that some of these subjects may still develop BC, when we investigated the role of the SNPs on cancer risk we considered two different scenarios: 1) cancer unaffected *versus* all cancer-affected; and 2) cancer unaffected *versus* ACC group. Similar allelic and genotypic frequencies were observed in these comparisons.

Moreover, median age at first diagnosis was earlier in GG carriers (*MDM2* SNP309) when compared to others genotypes for both cancers (age of 23 years vs 37 years), and also separately (ACC: age of 1 year vs 2 years; BC: age of 35 years vs 43 years, respectively, although with no significant difference. For *MDM4* and *USP7* gene SNPs, we did not find any pattern regarding to age at first diagnosis (**Table 3**).

Finally, we investigated the distribution of genotypes/alleles of the three SNPs according to tumor type among cancer-affected R337H mutation carriers. Although there were no differences on genotypic and allelic frequencies between ACC- and BC-affected carriers (**Table 4**) for any of the polymorphisms investigated, the *USP7* rs1529916 AG genotype was found in about 52% of ACC cases in comparison to 30% of the BC cases. Hardy-Weinberg equilibrium was achieved for all polymorphisms in both cases and control group.

Discussion

Mdm2, Mdm4 and Usp7 are three critical p53 regulators. Mdm2 and Mdm4 degrade p53 through the binding and polyubiquitination of the protein, blocking its activity as transcriptional factor (Lee and Gu, 2010). On the other hand, Usp7 play a role as a deubiquitinase, regulating the stability of p53 and the p53-binding

protein Mdm2. (Li et al., 2004; Brooks et al., 2007; Perry, 2010). Given the central role of these proteins on p53 signaling, in this study we investigated the impact of the most studied SNPs in the *MDM2*, *MDM4* and *USP7* genes on clinical manifestation (cancer risk, age at first diagnosis and tumor type) of *TP53* R337H mutation carriers.

To date, only a few genetic alterations have been shown to modify the LFS/LFL phenotype. Among these, a 16 bp duplication in the *TP53* gene, PIN3 (polymorphism intron 3), has been described as the germline variant with strongest modifier effect. In a study published by Marcel et al. the authors have found that cancer diagnosis occurred 19 years later in *TP53* germline mutation carriers with the 16 bp duplicated allele (Marcel et al., 2009). With regard to SNPs in *TP53*-related genes, although conflicting results, several publications have demonstrated the impact of *MDM2* SNP309 (T>G), a SNP located in the promoter region of *MDM2*, on earlier age of tumor onset in LFS patients carrying predominantly *TP53* DBD mutations (Ruijs et al., 2007; Tabori et al., 2007; Pinto et al., 2009; Renaux-Petel et al., 2014).

Here, although not statistically significant, *MDM2* G/G genotype was found in higher frequency in ACC cases, usually a tumor of early-onset, than BC cases (27.6% vs. 15.4%, respectively). In the same way, age at diagnosis was lower in *MDM2* SNP309 GG carriers when compared to other genotypes. The fact that none statistically significant differences were observed between these comparisons might be explained by the lack of statistic power. In this context, it would be required to genotype at least thirty-five subjects in each genotype in order to identify a difference of 10 years in the age at diagnosis, taking into account the dispersal of ages observed in this study (with 80% power and 5% alpha). We can also hypothesize that *MDM2* SNP309 has a limited contribution when isolated assessed. In fact, Renaux-Petel et al. have only observed an effect of *MDM2* SNP309 GG genotype on age of tumor onset when haplotype analyses were performed. The authors showed that *MDM2* SNP309 along with *MDM2* SNP285 (*MDM2* 285-309 G-G) develop tumors 5 years earlier than patients harbouring other haplotypes (Renaux-Petel et al., 2014). In contrast, Wu et al. using a robust and reliable statistical method to evaluate cancer risk attributable to

a measured hereditary susceptibility gene in family studies did not find a statistically significant interaction between *MDM2* SNP309 G allele and *TP53* mutation on cancer incidence (Wu et al., 2011).

Interestingly, we observed an enrichment of the *MDM2* SNP309 G allele in the R337H mutation carriers group (regardless of personal history of cancer) when compared to controls ($p=0.014$), suggesting that this SNP may contribute to the LFL phenotype in families carrying the R337H germline mutation. Similar to our findings, Ruijs et. al showed higher percentage of SNP309 homozygotes (G/G) in *TP53*-negative LFS and LFS-related patients when compared to the general populations. The authors suggested that SNP309 G polymorphism act as an additional disease-causing factor (Ruijs et al., 2007).

We also did not observe a significant association between *MDM4* rs1563828 and *USP7* rs1529916 polymorphisms with cancer risk, age at first diagnosis and tumor type in R337H mutation carriers. Although we have found a higher frequency of *USP7* rs1529916 AG genotype in ACC cases, its potential role on cancer type in R337H mutations should be investigated in a larger series of patients and with other *TP53* germline mutation in order to confirm its potential role as a genetic modifier. If confirmed, these findings may have important clinical implications.

Our study has several limitations that must be considered in the interpretation of the results. Although the relatively small sample size, due to the rarity of the syndrome, this is one of the largest cohorts used in the context of genetic modifiers of LFS/LFL. In addition, we investigated just one SNP of each gene and the haplotype analyses have not been performed at this time. Finally, differently of *MDM2* SNP309, the mechanistic basis of a potential negative effect of *MDM4* and *USP7* on p53 signaling remains unknown. On the other hand, a positive aspect of our study is the homogeneity of the cases. Here, all patients were carriers of a particular germline mutation, the *TP53* R337H. Due the particularities found in the clinical presentation of DBD mutation and R337H carriers, we believe that different SNPs in genes of the p53 pathway may affect the p53 function in different ways. To our knowledge, this is the first study to investigate genetic modifiers in LFL patients carrying the same germline mutation.

The information about polymorphisms with modifier effect of the LFS/LFL phenotype may have important implications in the cancer risk assessment. Although several reports showing the impact of *MDM2* SP309 on clinical manifestations of LFS families carrying mostly *TP53* DBD mutations, our data indicate that this functional SNP may also play a role on age at first diagnosis in patients carrying the R337H germline mutation. The enrichment of G allele and GG genotype in LFL patients, regardless of personal cancer history, also suggest that *MDM2* SP309 may have an additive impact on LFL phenotype. Haplotype analyses as well as a larger number of patients are needed in order to confirm our findings

Table legends:

Table 1. Clinical features of *TP53* R337H carriers and controls.

Table 2. Distribution of *MDM2*, *MDM4* and *USP7* polymorphisms among *TP53* R337H mutation carriers (affected or not by cancer) and controls.

Table 3. Distribution of mean age at first cancer diagnosis according to both polymorphism genotypes and cancer type.

Table 4. Distribution of *MDM2*, *MDM4* and *USP7* polymorphisms in *TP53* R337H carriers, according to tumor type.

Table 1.

	R337H mutation carriers			Controls
	ACC	BC	Cancer-unaffected	
Number of patients	29	43	60	186
Age at diagnosis/recruitment, Median (IQR)	2.5 (1-6.7)	42 (36-50)	33 (IQR 24-45)	52 (IQR 47-57)

* four patients developed other tumors

Table 2.

Polymorphisms	TP53 R337H carriers (cases)		Controls	P cancer vs. no cancer	P cases vs. controls
	non cancer	cancer			
MDM2		N(%)			
TT	18 (30.0)	25 (34.7)	79 (42.5)	0.600	0.042
TG	26 (43.3)	33 (45.8)	83 (44.6)		
GG	16 (26.7)	14 (19.4)	24 (12.9)		
TG + GG	42 (70.0)	47 (65.3)	107(57.5)	0.697	0.074
G	0.483	0.427	0.352		0.014
MDM4					
TT	12 (20.0)	16 (21.3)	25 (13.5)	0.799	0.115
TC	28 (46.7)	38 (50.7)	87 (47.0)		
CC	20 (33.3)	21 (28.0)	73 (35.5)		
TC+TT	40 (66.7)	54 (72.0)	112 (60.5)	0.630	0.119
T	0.433	0.466	0.370		0.217
HAUSP					
AA	5 (8.3)	5 (6.6)	13 (7)	0.792	0.983
AG	26 (43.3)	30 (39.5)	75 (40.5)		
GG	29 (48.4)	41 (53.9)	97 (52.4)		
GA + AA	31 (51.7)	35 (46.1)	88 (47.6)	0.633	0.954
A	0.300	0.263	0.273		0.648

Table 3.

Polymorphisms	Adrenocortical carcinoma			Breast cancer			All cancer cases		
	n (%)	Median (IQR)	<i>P</i>	n (%)	Median (IQR)	<i>P</i>	n (%)	Median (IQR)	<i>P</i>
<i>MDM2</i>									
TT	8 (28.5)	2 (0.7-5.25)	0.415*	15 (38.5)	43 (37-48)	0.638*	23 (34.3)	37 (3-46)	0.481*
TG	13 (46.5)	3 (1.5-10.5)		18 (46.2)	42 (35-52)		31 (46.3)	32 (6-44)	
GG	7 (25.0)	1 (1.0-5.0)		6 (15.4)	35 (25-60)		13 (19.4)	23 (1-41)	
TG + GG	20 (72.4)	2,5 (1.5 - 9.2)	0.412**	24 (61.5)	41 (32-56)	0.452**	44 (65.3)	28 (3.2-42)	0.534*
<i>MDM4</i>									
TT	4 (14.3)	2.5 (1.2-38.2)	0.620*	11 (26.2)	44 (19-57)	0.891*	15 (21.4)	40 (22-50)	0.456*
TC	15 (53.6)	2 (1-6)		19 (45.2)	42 (37-50)		34 (48.5)	36 (2-43)	
CC	9 (32.1)	5 (0.8-11)		12 (28.6)	40 (36-54)		21 (30.0)	32 (5.5-42)	
TC+TT	19 (67.9)	2 (1-6)	0.487**	30 (71.4)	42 (36-50)	0.770**	49 (70.0)	36 (3-45.5)	0.667**
<i>HAUSP</i>									
AA	2 (7.1)	3-22	0.446*	3 (7.0)	36-39	0.821*	5 (7.0)	39 (19.5 - 42.5)	0.442*
AG	14 (50.0)	1.5 (1-10.2)		13 (30.2)	40 (36-54)		27 (38.0)	29 (1-42)	
GG	12 (42.9)	3 (1-5.7)		27 (62.8)	43 (32 -47)		39 (55.0)	36 (6-46)	
GA + AA	16 (57.1)	2 (2.40.2)	0.888**	16 (37.2)	39.5 (36.2 - 37.7)	0.900**	32 (45.1)	36 (2-42)	0.293**

Interquartile Range (IQR)

**Mann-Withney test

*Kruskal-Wallis Test

Table 4.

Polymorphisms	Adrenocortical carcinoma	Breast cancer	P
MDM2			
TT	7 (27.6)	15 (38.5)	0.408
TG	13 (44.8)	18 (46.2)	
GG	8 (27.6)	6 (15.4)	0.498
TG + GG	21 (72.4)	24 (61.5)	
MDM4			
TT	5 (17.2)	11 (26.2)	0.672
TC	15 (51.7)	19 (45.2)	
CC	9 (31)	12 (28.6)	1,000
TC+TT	20 (69.0)	30 (71.4)	
HAUSP			
AA	2 (6.9)	3 (7.0)	0,172
AG	15 (51.7)	13 (30.2)	
GG	12 (41.4)	27 (62.8)	0,122
GA + AA	17 (58.6)	16 (37.2)	

References

- Achatz, M.I., Olivier, M., Le Calvez, F., Martel-Planche, G., Lopes, A., Rossi, B.M., Ashton-Prolla, P., Giugliani, R., Palmero, E.I., Vargas, F.R., Da Rocha, J.C., Vettore, A.L. and Hainaut, P., 2007. The TP53 mutation, R337H, is associated with Li-Fraumeni and Li-Fraumeni-like syndromes in Brazilian families. *Cancer Lett* 245, 96-102.
- Bougeard, G., Baert-Desurmont, S., Tournier, I., Vasseur, S., Martin, C., Brugieres, L., Chompret, A., Bressac-de Paillerets, B., Stoppa-Lyonnet, D., Bonaiti-Pellie, C. and Frebourg, T., 2006. Impact of the MDM2 SNP309 and p53 Arg72Pro polymorphism on age of tumour onset in Li-Fraumeni syndrome. *J Med Genet* 43, 531-3.
- Brooks, C.L., Li, M., Hu, M., Shi, Y. and Gu, W., 2007. The p53--Mdm2--HAUSP complex is involved in p53 stabilization by HAUSP. *Oncogene* 26, 7262-6.
- Caleffi, M., Ribeiro, R.A., Duarte Filho, D.L., Ashton-Prolla, P., Bedin, A.J., Skonieski, G.P., Zignani, J.M., Giacomazzi, J., Franco, L.R., Graudenz, M., Pohlmann, P., Fernandes, J.G., Kivitz, P. and Weber, B., 2009. A model to optimize public health care and downstage breast cancer in limited-resource populations in southern Brazil. (Porto Alegre Breast Health Intervention Cohort). *BMC Public Health* 9, 83.
- Custódio, G., Parise, G.A., Kiesel Filho, N., Komechen, H., Sabbaga, C.C., Rosati, R., Grisa, L., Parise, I.Z., Pianovski, M.A., Fiori, C.M., Ledesma, J.A., Barbosa, J.R., Figueiredo, F.R., Sade, E.R., Ibañez, H., Arram, S.B., Stinghen, S.T., Mengarelli, L.R., Figueiredo, M.M., Carvalho, D.C., Avilla, S.G., Woiski, T.D., Poncio, L.C., Lima, G.F., Pontarolo, R., Lalli, E., Zhou, Y., Zambetti, G.P., Ribeiro, R.C. and Figueiredo, B.C., 2013. Impact of neonatal screening and surveillance for the TP53 R337H mutation on early detection of childhood adrenocortical tumors. *J Clin Oncol* 31, 2619-26.
- DiGiammarino, E.L., Lee, A.S., Cadwell, C., Zhang, W., Bothner, B., Ribeiro, R.C., Zambetti, G. and Kriwacki, R.W., 2002. A novel mechanism of tumorigenesis involving pH-dependent destabilization of a mutant p53 tetramer. *Nat Struct Biol* 9, 12-6.
- Giacomazzi, J., Selistre, S.G., Rossi, C., Alemar, B., Santos-Silva, P., Pereira, F.S., Netto, C.B., Cossio, S.L., Roth, D.E., Brunetto, A.L., Zagonel-Oliveira, M., Martel-Planche, G., Goldim, J.R., Hainaut, P., Camey, S.A. and Ashton-Prolla, P., 2013. Li-Fraumeni and Li-Fraumeni-like syndrome among children diagnosed with pediatric cancer in Southern Brazil. *Cancer* 119, 4341-9.
- Lee, J.T. and Gu, W., 2010. The multiple levels of regulation by p53 ubiquitination. *Cell Death Differ* 17, 86-92.
- Li, F.P. and Fraumeni, J.F., 1969a. Rhabdomyosarcoma in children: epidemiologic study and identification of a familial cancer syndrome. *J Natl Cancer Inst* 43, 1365-73.
- Li, F.P. and Fraumeni, J.F., 1969b. Soft-tissue sarcomas, breast cancer, and other neoplasms. A familial syndrome? *Ann Intern Med* 71, 747-52.
- Li, F.P., Fraumeni, J.F., Mulvihill, J.J., Blattner, W.A., Dreyfus, M.G., Tucker, M.A. and Miller, R.W., 1988. A cancer family syndrome in twenty-four kindreds. *Cancer Res* 48, 5358-62.

- Li, M., Brooks, C.L., Kon, N. and Gu, W., 2004. A dynamic role of HAUSP in the p53-Mdm2 pathway. *Mol Cell* 13, 879-86.
- Malkin, D., 2011. Li-fraumeni syndrome. *Genes Cancer* 2, 475-84.
- Malkin, D., Li, F.P., Strong, L.C., Fraumeni, J.F., Nelson, C.E., Kim, D.H., Kassel, J., Gryka, M.A., Bischoff, F.Z. and Tainsky, M.A., 1990. Germ line p53 mutations in a familial syndrome of breast cancer, sarcomas, and other neoplasms. *Science* 250, 1233-8.
- Marcel, V., Palmero, E.I., Falagan-Lotsch, P., Martel-Planche, G., Ashton-Prolla, P., Olivier, M., Brentani, R.R., Hainaut, P. and Achatz, M.I., 2009. TP53 PIN3 and MDM2 SNP309 polymorphisms as genetic modifiers in the Li-Fraumeni syndrome: impact on age at first diagnosis. *J Med Genet* 46, 766-72.
- Palmero, E.I., Schüler-Faccini, L., Caleffi, M., Achatz, M.I., Olivier, M., Martel-Planche, G., Marcel, V., Aguiar, E., Giacomazzi, J., Ewald, I.P., Giugliani, R., Hainaut, P. and Ashton-Prolla, P., 2008. Detection of R337H, a germline TP53 mutation predisposing to multiple cancers, in asymptomatic women participating in a breast cancer screening program in Southern Brazil. *Cancer Lett* 261, 21-5.
- Perry, M.E., 2010. The regulation of the p53-mediated stress response by MDM2 and MDM4. *Cold Spring Harb Perspect Biol* 2, a000968.
- Pinto, C., Veiga, I., Pinheiro, M., Peixoto, A., Pinto, A., Lopes, J.M., Reis, R.M., Oliveira, C., Baptista, M., Roque, L., Regateiro, F., Cirnes, L., Hofstra, R.M., Seruca, R., Castedo, S. and Teixeira, M.R., 2009. TP53 germline mutations in Portugal and genetic modifiers of age at cancer onset. *Fam Cancer* 8, 383-90.
- Renaux-Petel, M., Sesboüé, R., Baert-Desurmont, S., Vasseur, S., Fourneaux, S., Bessenay, E., Frébourg, T. and Bougeard, G., 2014. The MDM2 285G-309G haplotype is associated with an earlier age of tumour onset in patients with Li-Fraumeni syndrome. *Fam Cancer* 13, 127-30.
- Ribeiro, R.C., Sandrini, F., Figueiredo, B., Zambetti, G.P., Michalkiewicz, E., Lafferty, A.R., DeLacerda, L., Rabin, M., Cadwell, C., Sampaio, G., Cat, I., Stratakis, C.A. and Sandrini, R., 2001. An inherited p53 mutation that contributes in a tissue-specific manner to pediatric adrenal cortical carcinoma. *Proc Natl Acad Sci U S A* 98, 9330-5.
- Ruijs, M.W., Schmidt, M.K., Nevanlinna, H., Tommiska, J., Aittomäki, K., Pruntel, R., Verhoef, S. and Van't Veer, L.J., 2007. The single-nucleotide polymorphism 309 in the MDM2 gene contributes to the Li-Fraumeni syndrome and related phenotypes. *Eur J Hum Genet* 15, 110-4.
- Tabori, U., Nanda, S., Druker, H., Lees, J. and Malkin, D., 2007. Younger age of cancer initiation is associated with shorter telomere length in Li-Fraumeni syndrome. *Cancer Res* 67, 1415-8.
- Vousden, K.H. and Prives, C., 2009. Blinded by the Light: The Growing Complexity of p53. *Cell* 137, 413-31.
- Wu, C.C., Krahe, R., Lozano, G., Zhang, B., Wilson, C.D., Jo, E.J., Amos, C.I., Shete, S. and Strong, L.C., 2011. Joint effects of germ-line TP53 mutation, MDM2 SNP309, and gender on cancer risk in family studies of Li-Fraumeni syndrome. *Hum Genet* 129, 663-73.

Capítulo V. Increased redox metabolism and perturbed DNA damage responses in primary fibroblasts from Li-Fraumeni syndrome patients.

Artigo a ser submetido ao periódico *Scientific Reports*.

Increased redox metabolism and perturbed DNA damage responses in primary fibroblasts from Li-Fraumeni syndrome patients.

Gabriel S. Macedo^{1,2}, Sylvie Sauvaigo³, Ivi Bristot⁴, Rodrigo Ligabue-Braun⁵, Igor Araujo Vieira^{1,2}, Fernanda Timm Seabra Souza⁷, Michele Silva Alves⁶, Sylvain Caillat³, Cristina Brinckmann Oliveira Netto⁷, Mauro Antonio Alves Castro⁸, Pierre Hainaut⁹, Fabio Klamt⁴, Patricia Ashton-Prolla^{1,2,7}

¹Post-Graduate Program in Genetics and Molecular Biology, Universidade Federal do Rio Grande do Sul (UFRGS), Porto Alegre, 15053, Rio Grande do Sul, Brazil.

²Genomic Medicine Laboratory, Experimental Research Center, Hospital de Clínicas de Porto Alegre (HCPA), Porto Alegre, 1247, Rio Grande do Sul, Brazil.

³LXRepair, Grenoble, France.

⁴Laboratory of Cellular Biochemistry, Department of Biochemistry, Universidade Federal do Rio Grande do Sul, Porto Alegre, RS, Brazil.

⁵Center of Biotechnology, Universidade Federal do Rio Grande do Sul Porto Alegre, RS, Brazil.

⁶Service of Medical Physics and Radioprotection, HCPA, Porto Alegre, 1247, Rio Grande do Sul, Brazil

⁷Serviço de Genética Médica, Hospital de Clínicas de Porto Alegre (HCPA), Porto Alegre, RS, Brazil

⁸Bioinformatics and Systems Biology Laboratory, Federal University of Paraná (UFPR), Polytechnic Center, Curitiba, Brazil

⁹Institut Albert Bonniot- INSERM 823, University Grenoble-Alpes, Grenoble, France.

Correspondence:

Gabriel de Souza Macedo

Laboratório de Medicina Genômica, Centro de Pesquisa Experimental, Hospital de Clínicas de Porto Alegre

Rua Ramiro Barcelos, 2350

Porto Alegre 90035-903, RS, Brazil

Telephone: +55 51 3359.7661

Fax number: +55 51 3359.8761

e-mail: gmacedoufrgs@gmail.com

Conflict of interest: The authors have no conflicts of interest to declare.

Abstract

Background: Li-Fraumeni Syndrome (LFS) is a familial cancer predisposition syndrome associated with *TP53* germline mutations and characterized by high risk for multiple early-onset cancers. While many *TP53* mutations occur at hotspot within the DNA binding domain of the protein, studies in families from Southern and Southeastern Brazil have identified a frequent penetrant founder *TP53* mutation, R337H, occurring in the C-terminal oligomerisation domain. Here we have investigated redox metabolism and DNA damage response, two essential biological processes controlled by p53, in primary fibroblasts of Brazilian LFS subjects carrying R337H or classical “hotspot” *TP53* mutations. **Methods:** Primary fibroblast cultures from patients with *TP53* genotypes R337H/WT (n=3), R337H/R337H (n=1), G245S/WT (n=1), R273H/WT (n=1) and from subjects with wild-type *TP53* (controls, n=3) were studied. DNA damage was induced using UVB (0.2 W/m²) or ionizing irradiation (IR) (1 Gy). DNA damage responses were assessed using a multiplexed enzymatic DNA repair assay on biochip and redox metabolism was analyzed with high-resolution respirometry and conventional methodologies. **Results:** Compared to wild-type controls, fibroblasts with mutant *TP53* appeared to have higher levels of Reactive Oxygen Species (ROS) and this effect was more marked for R337H/R337H cells than for cells harboring heterozygote mutations. Increased mitochondrial respiration was seen exclusively in fibroblasts of a patient carrying a hotspot mutation (R273H). DNA repair activities in response to UV or IR damage showed that activities in R337H heterozygote cells were essentially comparable to control cells, whereas R337H/R337H cells exhibited significantly increased repair activities at 24h after damage, suggesting the persistence of significant DNA damage in these cells. Interestingly, all mutant p53 fibroblasts showed higher repair activity of apurinic/pyrimidinic (AP) sites, a DNA lesion caused mainly by intensive ROS exposure. **Conclusions:** These results show that normal cells from LFS subjects have an hyperoxic phenotype characterized by high ROS levels, associated with a tendency for slower repair and more persistent DNA damage. These results suggest that anti-oxidant prevention may have an impact to reduce cancer risk in LFS.

Introduction

Li-Fraumeni syndrome (LFS) is a rare hereditary disorder that greatly increases the risk of developing several early-onset cancers, including sarcoma, brain tumours, adrenal cortical carcinoma and early breast cancer¹. The only known genetic defect underlying LFS is germline *TP53* mutation, which is commonly found in about 30% of the families matching current clinical criteria². The vast majority of germline *TP53* mutations are distributed in highly conserved regions encoding exons 5-8, corresponding to the DNA-binding domain (DBD) of p53 (<http://www-p53.iarc.fr/index.html>). The main mutational hotspots are R175, G245, R248, R249, R273 and R282, all resulting in missense substitutions that directly hamper DNA binding³.

It is estimated that germline *TP53* mutations occur at an average frequency of 1/10,000-1/25,000 births⁴. In Southern and Southeastern Brazil, however, a founder *TP53* mutation has been detected in many families that show predisposition to at least some of the cancers of the LFS spectrum^{5,6}. This mutation, R337H (c.1010G>A, p.Arg337His), is thought to occur in about 1/300 births in Southern Brazil^{7,8}. Unlike hotspot mutations, it affects an arginine residue located in the oligomerisation domain (OD) of p53. This domain mediates the association of p53 into tetramers, the preferred configuration for high-affinity binding to DNA⁹. Structure prediction and biochemical studies suggest that R337H precludes correct p53 oligomerisation at intracellular pH in the higher physiological range (7.5-8.0)^{10,11}. However, the precise mechanistic impact of this mutation on p53 protein activities is still unknown.

The p53 protein is a crucial tumor suppressor which regulates multiple anti-proliferative pathways in response to diverse stress signals, including genotoxic damage, physical stress, oncogene activation and nutrient or oxygen deprivation¹². The protein is a transcription factor which binds to response elements (REs) in regulatory regions of multiple target genes, including genes mediating cell cycle arrest, apoptosis, autophagy, senescence, and DNA repair¹³. In recent years, it has emerged that p53 is a major regulator of cell bioenergetic metabolism that promotes oxidative phosphorylation, dampens glycolysis, and controls the intracellular production of ROS¹⁴⁻¹⁶, raising the hypothesis that

constitutive *TP53* deficiency in LFS may cause a metabolic cancer-prone syndrome. Indeed, mice with disrupted *trp53* alleles show severe impairment of oxidative metabolism. Quite surprisingly, however, *TP53* mutation carriers have increased mitochondrial function and oxidative phosphorylation of skeletal muscle as compared to non-carrier controls¹⁷. Compatible with these observations, we have observed that R337H mutation carriers had increased indicators of plasma protein and lipid damage associated with altered anti-oxidant balance, as compared to non-carriers¹⁸. Thus, presence of a germline *TP53* mutation appears to cause a baseline defect in redox metabolism, which in turn may increase the formation of oncogenic DNA damage, thus increasing the probability of developing early cancer.

In this study, we have used primary fibroblasts derived from *TP53* mutation carriers to investigate the impact of constitutive germline *TP53* mutation on p53-dependent responses regulating oxidative metabolism and DNA repair. We have used fibroblasts derived from patients carrying typical hotspot p53 mutations (R273H, R245G) as well as from patients carrying the Brazilian founder mutation R337H. Although germline *TP53* mutation is usually inherited as an heterozygous trait (one mutant and one wild-type allele), in Brazil, the high population prevalence of R337H causes rare cases of bi-allelic (homozygous) mutations inherited from parents who are both carriers⁸, and we have also used primary fibroblasts derived from such a patient. To investigate DNA damage responses, we have applied innovative biochip assays for measuring excision/synthesis and base-excision repair activities towards several common types of DNA lesions (Exy-SPOT and Glyco-SPOT assays, LX Repair, Grenoble, France). Our results further demonstrate that germline *TP53* mutation causes disruption of baseline redox metabolism and results in imbalance in DNA repair, and that the extent of these effects may differ between hotspot mutations in the DNA-binding domain and R337H mutation in the C-terminal oligomerisation domain.

Material and methods

Subjects, fibroblast cultures and ethical aspects

Primary fibroblast cultures were obtained by skin biopsy. Briefly, skin fragments of 2 mm in diameter from 9 different individuals were collected under aseptic conditions and immediately transferred to sterile Petri dishes containing HAM-F10 cell culture medium plus 20% fetal bovine serum (FBS). These fragments were cut into several pieces and then transferred to the polystyrene cell culture flask Falcon T25 type containing HAM-F10 cell culture medium plus 20% FBS. When cells from the skin fragments presented adequate growth, they were detached from the bottom of the flask with 0.25% trypsin-EDTA and transferred to two new sterile flasks containing DMEM cell culture medium plus 10% FBS and kept in incubators at 37 °C.

TP53 genotypes of the eight individuals biopsied were: R337H/WT (n=2), R337H/R337H (n=1), G245S/WT (n=1), R273H/WT (n=1) and WT/WT (n=3). All individuals recruited for this study had been previously ascertained as being carriers or non-carriers of *TP53* germline mutations by standard sequencing protocols (http://www-p53.iarc.fr/Download/TP53_DirectSequencing_IARC.pdf). All patients were in remission and/or asymptomatic for at least 36 months at the time of inclusion in the study. The study was approved by the Institutional Ethics Committee of Hospital de Clínicas de Porto Alegre under protocol number 10-0405. All participants were recruited only after informed consent (provided by legal representatives in the case donors aged less than 18 years).

Cell culture and DNA damage induction

Fibroblasts (3-6 passages) were grown in humidified incubators at 5% CO₂ and 37°C and maintained in DMEM medium that was prepared with 1% penicillin/streptomycin and supplemented with 10% fetal bovine serum (all reagents were from Gibco Laboratories, USA). Cultured cell flasks from each subject with distinct *TP53* genotypes were exposed either to UVB (0.2W/m²) or ionizing radiation (IR) at a dose of 1 Gy (treated cells) or not irradiated (untreated controls). Treated cells were used for DNA damage response experiments and untreated cells were used for metabolism analyses as well as for DNA damage response experiments.

ROS production and Mitochondrial density

ROS production was measured by immunofluorescence using the DCF-DA (2',7'-dichlorodihydrofluorescein diacetate) probe^{19,20}. Briefly, the culture medium was removed and 10 μ M DCF-DA was added. Fluorescence was measured in a plate reader (Spectra Max GEMINI XPS, Molecular Devices, USA) with excitation at 485 nm and emission at 520 nm. Mitochondrial density was obtained by using MitoTracker Orange CMTMRos (Molecular probes M-7510, Oregon, USA). Briefly, cells were washed in PBS 1X and then incubated for 30 min in growth medium containing 300nM of probe. After staining the solution was replaced by fresh prewarmed media²¹. Cells were visualized in a fluorescence microscope (BX51; Olympus, Tokyo, Japan).

Cellular oxygen consumption

Cellular oxygen consumption was quantified by high-resolution respirometry using the Oroboros® Oxygraph-2K (Oroboros Instruments, Innsbruck, Austria). Respiration was measured at 37°C with about 0,7-1,5 million intact fibroblasts in each chamber containing 2 mL of DMEN (without fetal bovine serum). Flux control ratios (FCRs) were calculated to express respiratory control independent of mitochondrial content and cell size. FCRs were normalized for maximum flux in a common reference state, to define theoretical lower and upper limits of 0.0 and 1.0²².

DNA repair activities and data treatment

The fibroblasts from each individual were plated in six 125cm² flasks for DNA damage response experiments. Two flasks were treated with UVB, two treated with IR and the two remaining were used as untreated controls. Twenty-four hours after treatments, cells were trypsinized and pelleted by centrifugation at 2000 rpm for 10 min. The pellets were suspended in DMEM medium with 10% DMSO and frozen in liquid nitrogen until the preparation of cell extracts. Cell nuclear extracts were prepared as previously described²³ and protein content was determined using the BCA kit (Interchim, Montlucon, France). Two distinct repair assays were performed using two different biochips^{23,24}. The first assay (Exy-

SPOT) enables the quantification of excision/synthesis repair activities towards six different lesions, including: photoproducts (cyclobutane pyrimidine dimers and 6-4 photoproducts; CPD-64), 8-oxoguanine (8-oxoG), alkylated bases (AlkB), cisplatin adducts (CisP), abasic sites (AbaS) and cytosine and thymine glycols (glycol)²³. The second assay (Glyco-SPOT) enables the quantification of base- excision repair activities for the following target lesions: 8-oxoguanine paired with A, A paired with 8-oxoguanine, ethenoadenine, thymine glycol, uracil (paired either with G or A), hypoxanthine and abasic site²⁴. Results were expressed as the ratio of (fluorescence intensity) FI obtained for each lesion and treatment condition between the treated (T) and non-treated (NT) samples. Raw values from DNA repair intensity estimates were transformed in order to share the scale among the different assays and Z scores were calculated relative to the average of subgroups tested in each case. Unsupervised clustering analysis was performed in *R* (<https://www.r-project.org/>) and a multi-scale resampling approach accessed the stability of the clustering using the package *pvclust*²⁵ which executes a bootstrap analysis (n=1000) and counts how many times a given cluster can be observed from the bootstrap subsamples (the approximate unbiased p-values (AU) and bootstrap probability p-values (BP) are expressed as percentages and indicate how strongly the cluster is supported by the data).

Protein analysis by Western Blot

Treated (IR) and untreated fibroblasts were collected and lysed 24 hours after DNA damage induction and prepared for western blotting as previously described, with minor modifications^{18,26}. Primary antibodies used were: Glutathione peroxidase 1 (1:500, Cell Signalling, Beverly, MA), Superoxide dismutase 2 (1:1000, Cell Signalling, Beverly, MA), Apurinic/aprimidinic (AP) endonuclease (1:500, Cell Signalling, Beverly, MA) and TP53-inducible glycolysis and apoptosis regulator (TIGAR) (1:500, Santa Cruz Biotechnology). β -actin (1:70000) was used as an endogenous control and the band density was analyzed using the ImageJ software.

Results

Baseline cell metabolism analysis

Figure 1a summarizes the characteristics of the primary fibroblasts donors who participated to this study, including their *TP53* genotypes. The age of the donors ranged from 14 to 55 years. Carriers of R337H included one carrier without cancer diagnosed at the age of 41 years and two carriers who developed adrenal cortical carcinoma in early childhood. Among these two patients, one was heterozygote and the other homozygote for the mutation. Schematic diagram (**Figure 1b**) and tridimensional structure (**Figure 1c**) of the p53 protein indicating domains and mutation location are also shown. The familial and clinical profile of this patient has been documented elsewhere. Of note, this patient does not appear to show a more severe clinical pattern than heterozygote mutation carriers.

To study the functional impact of different p53 mutants on baseline cell metabolism (minimal stress from cell culture in the absence of irradiation treatments), we first investigated several parameters of mitochondrial physiology in primary fibroblast cultures from patients carrying distinct *TP53* mutations and from controls. As shown in **Figure 2a**, fibroblasts expressing p53 mutant had higher baseline levels of Reactive Oxygen Species (ROS) than fibroblasts with wild-type p53. The increase in ROS levels as compared to controls was lower for heterozygote carriers (average: +33% in R337H heterozygotes, +50% in heterozygote carriers of hotspot mutations, $p=0.013$ and $p=0.199$, respectively). In contrast, a much higher increase (+159%, $p=0.009$) was seen in the fibroblasts from the homozygote R337H carrier. Additionally, SOD2 and GPX1, two antioxidant proteins, were detected at consistently higher levels in R337H homozygote (both) and heterozygote (only SOD2) fibroblasts, suggesting antioxidant response to increased ROS production (**Figure 2b**).

We next performed high-resolution respirometry (HRR) in intact cells to examine mitochondrial function. Although some variations were detected, all parameters (routine, ATP-linked, extramitochondrial, reserve and maximal respiration as well as H⁺ leak) were essentially similar in fibroblasts from R337H heterozygote and homozygote carriers, as compared to controls. In the R273H heterozygote fibroblasts, however, all parameters were significantly increased,

demonstrating a clear increased in mitochondrial oxidative activity (**Figure 2c** and **d**). Notably, mitochondrial density was consistently increased in fibroblasts from *TP53* mutation carriers than in fibroblasts from noncarriers (**Figure 2e**). Overall, these results suggest that constitutive *TP53* mutation is associated with an increase in intracellular ROS production, which may in turn result from enhance mitochondrial oxidative activity. While this effect is marginal in R337H heterozygote cells, probably due to partial compensation by the remaining wild-type *TP53* allele, it is much stronger in homozygote mutant cells, probably due to the compound effect of the biallelic mutation.

DNA repair analysis in response to DNA damage

In a previous study, we have shown increased ROS-induced damage to lipid and proteins in the plasma of *TP53* mutation carriers¹⁸. To determine whether increased ROS levels may also impact on DNA repair in response to DNA damage, we next studied the impact of germline mutations on DNA damage response in primary fibroblasts submitted to UVB or ionizing radiation (IR). DNA repair was analyzed using biochip-based assays that detect and quantify the capacity of cell extracts to perform the repair of specific lesions in DNA fragments immobilized on a matrix (see methods). Using these assays, we investigated nucleotide excision repair (NER) activities (CPD and 6-4PPs, Pso lesions) and base excision repair (BER) activities (8oxoG, AlkB, AbaS and glycol lesions) in untreated cells and after UVB or IR-induced DNA damage. Principal Component Analysis (PCA) analysis of the DNA repair of different lesions in distinct conditions is shown in **Figure S1**. The axis of the analysis successfully discriminated the fibroblasts by separating the three cellular conditions: non-treated, UVB and IR, indicating that treatments were effective.

Results for NER activities (Exy-Spot assay, **Figure 3a** and **b**) clearly distinguished between two different types of responses to DNA damage among the tested primary fibroblast cultures. With UV (**Figure 3a**), WT/WT (control) and R337H/WT fibroblasts retained constant or even slightly decreased DNA repair activities for all lesions 24h after treatment. In contrast heterozygote hotspot mutants and the R337H homozygote fibroblasts showed increased DNA repair

activities 24h after treatment. With IR (**Figure 3b**), only R337H homozygote fibroblasts showed increased DNA repair activities 24h after treatment, in contrast to all heterozygote fibroblasts as well as controls showing the same DNA repair activity as at baseline (untreated fibroblasts).

Results for BER activities showed that DNA repair activities 24h after treatment were identical to baseline for all lesions except apurinic/pyrimidinic (AP) sites (THF-A), at type of DNA lesions caused mainly by ROS attack, in *TP53* mutated fibroblasts when compared to controls (**Figure 4a-c**). In contrast to WT/WT fibroblasts in which unchanged repair activity after UVB and IR treatments was observed, p53 mutant cell showed high repair activity of THF-A, indicating that in the latter cells a substantial DNA damage response was still ongoing at 24h after treatment. Western blot analysis of Ape1 protein levels, the enzyme that recognizes abasic sites, revealed that in response to DNA damage (IR), Ape1 was downregulated in mutant p53 fibroblasts when compared to controls (**Figure 4d**).

Discussion

It is well known that p53 is a tumor suppressor protein that responds to multiple stress signals by inducing cell cycle arrest, apoptosis and senescence¹³. In recent years, a number of studies have shown that in addition to these functions, p53 also operates as a regulator of cell oxidative metabolism and energy production²⁷⁻²⁹. Although hundreds of studies have characterized the role of the wild-type p53 and its multiple tumor suppression activities³⁰⁻³², the functional impact of mutant p53, especially those found in Li-Fraumeni patients, is not completely understood. Thus, here we aimed to characterize the functional impact of *TP53* germline mutations identified in Brazilian families, especially the R337H founder mutation. Our data indicate an hyperoxic phenotype characterized by high ROS levels, associated with a tendency for slower repair and more persistent DNA damage in normal cells (fibroblasts) from LFS patients.

Recently, we have shown that subjects who carry the *TP53* R337H in their germline have higher levels of several parameters of oxidative stress as well as alterations in their antioxidant content in plasma when compared to subjects who do not carry a *TP53* mutation¹⁸. In the present study, we provided further evidence

of oxidative imbalance in Li-Fraumeni syndrome. The increased ROS production found in all mutant p53 fibroblasts when compared to controls corresponds at cell level to the hyperoxic phenotype previously observed in blood. Although not common to all mutated p53 cells, GPX1 and SOD2 protein expression appear to be higher in mutant cells than in controls, with a remarkable GPX1 expression in fibroblasts from the R337H homozygote carrier. These results suggest an antioxidant response to increased ROS production. Our findings are also in agreement to the initial description of the wild-type p53 role on ROS downregulation. In this study Sablina *et al.* demonstrated that wild-type p53 up regulates several genes with antioxidant functions, including GPX1 and sestrins. The authors also found that mutant p53 increased intracellular ROS leading to genomic instability and karyotype abnormalities³³. Taking together, these findings indicate that R337H and at least some DBD (e.g R273H) mutations result in a hyperoxic phenotype probably due to an antioxidant deficiency. We can also conclude that this effect is attenuated by the remaining *TP53* wild-type, so that it is subtle in R337H heterozygote cells, but remarkable in R337H homozygote fibroblasts.

The role of p53 in mitochondrial respiration and glucose metabolism is emerging¹⁵. Several studies have found that p53 can limit glycolytic flux through a number of mechanisms, such as gene repression of glucose transporters, insulin receptor, phosphoglycerate mutase (PGM) and *TP53*-induced glycolysis and apoptosis regulator (TIGAR). On the other hand, p53 seems to promote oxidative phosphorylation (OXPHOS), therefore, favoring the use of TCA for energy production¹⁶. Wang *et al.* demonstrated increased mitochondrial function associated to high levels of mitochondrial transcription factor A (TFAM) and the synthesis of cytochrome *c* oxidase 2 (SCO2), two mitochondrial biogenesis regulators, in cultured lymphocytes and myoblasts from p53 DBD mutation carriers. Increased mitochondrial function was also supported by studies in LFS mouse model (Wang *et al.*, 2013). Thus, our study was designed to verify whether this metabolic phenotype is also found in a mutant outside of the DBD of p53, such as R337H. Although all p53 mutant fibroblasts appear to have higher mitochondrial biomass, in agreement with previous findings¹⁷, substantial oxygen consumption

was not seen in R337H heterozygote and homozygote cells, but in R273H fibroblasts (DBD mutation). Moreover, while R337H heterozygote cells showed similar profile to wild-type p53 cells in most of parameters, R337H homozygote fibroblasts were characterized by lower production of ATP and higher H⁺ Leak (linked to ROS production). As expected, all parameters except reserve respiration capacity were higher in the DBD p53 mutated fibroblasts, meaning that these cells are using almost all of their maximal respiration to produce the same percentage of ATP than wild-type or R337H heterozygote cells. Thus, our results suggest that DBD mutations are associated to an increase in the oxygen consumption rate (gain-of-function), while R337H (OD mutation) is associated exclusively to antioxidant function deficiency (loss-of-function).

Although several *in vitro* studies have been performed to predict response and potential consequences of radiation exposure in LFS/LFL patients³⁴⁻³⁶, to the best of our knowledge this is the first study to investigate repair of specific DNA lesions/pathways in a context of inherited p53 defects. Here, we observed distinct DNA repair patterns, according to DNA damage inducing treatment used and *TP53* genotype. Fibroblasts carrying a DBD mutation (G245S) showed a poor DNA repair capacity for all lesions in response to both UVB and IR. In fact, the G245S mutant protein has been shown to cause a local conformation distortion and it is unable to bind to p53 target response elements^{37,38}. Several other studies also reported impaired apoptotic response and G1/G2 arrest after DNA damage induced by radiation in LFS patient-derived cells carrying DBD mutations³⁹⁻⁴¹. With regard to R337H mutation, DNA damage seems to persist 24 hours after treatment, with a more pronounced DNA repair activity in homozygote cells. In contrast, p53 wild-type fibroblasts repair DNA very quickly and are back to baseline at a time mutant cells are still repairing DNA lesions. Although our functional analyses reveal differences between R337H homozygous and heterozygous fibroblasts, from a clinical point of view *TP53* R337H homozygote do not have a more severe disease phenotype than do heterozygote carriers⁵. Overall DNA damage response experiments show that DNA repair is slower and maybe partial in LFS fibroblasts. It may be due to ROS damage overwhelming the DNA repair machinery, but additional experiments are needed in order to confirm it.

The Glyco-SPOT assay revealed a higher excision rate of apurinic/pyrimidinic (AP) sites (THF-A) in all mutant p53 fibroblasts when compared to their wild-type counterparts. Interestingly, AP sites are DNA lesions caused mainly by ROS attack⁴², so this aligned with our observation of increased ROS production in p53-mutated cells. Although we have observed increased AP sites repair in p53 mutant fibroblasts, Ape1 (Apurinic/Apyrimidmic Endonuclease 1) expression, a protein that plays a central role in base excision repair (BER) pathway, appeared to be downregulated in response to IR in cells from Li-Fraumeni patients. In fact, it has been shown recently that DNA damage accumulation activates p53, which in turn triggers a downregulation of APE1 (Poletto et al., 2016).

Our data provide evidence to suggest that R377H (OD) is associated with impaired redox homeostasis and sustained DNA repair activity, with a remarkable hyperoxic phenotype in R337H homozygote fibroblasts. Moreover, while the *TP53* R337H mutant appears to impair exclusively the antioxidant function of p53, a DBD mutation (R273H) also cause gain-of-function in terms of oxygen consumption rate. Although we observed similarities in the DNA damage response from R337H heterozygotes when compared to wild-type *TP53* cells, R337H homozygous fibroblasts show an entirely different DNA repair response. These findings provide further evidence of a defective bioenergetic profile in LFS, which may in turn be associated to cancer development.

Acknowledgments

This study was supported by grants from the Conselho Nacional de Desenvolvimento Científico e Tecnológico (CNPq), Fundação de Amparo à Pesquisa do Estado do Rio Grande do Sul, and Fundo de Incentivo à Pesquisa e Eventos at the Hospital de Clínicas de Porto Alegre.

Figure S1.

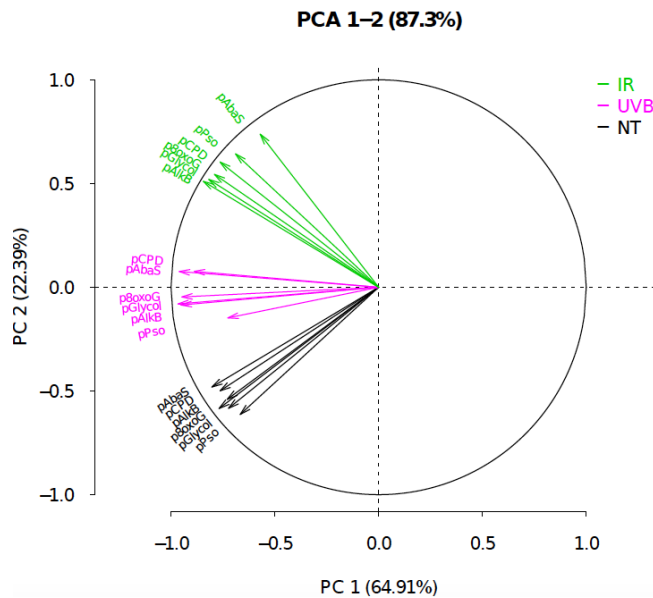

Figure S1. Principal component analysis (PCA). Correlation circle of principal component analysis (PCA) performed on the interaction between the different DNA lesions and treatments. Neighboring arrows reflect strong correlations between the different lesions in the same treatment. IR (Ionizing radiation); NT (non-treated).

Figure 1

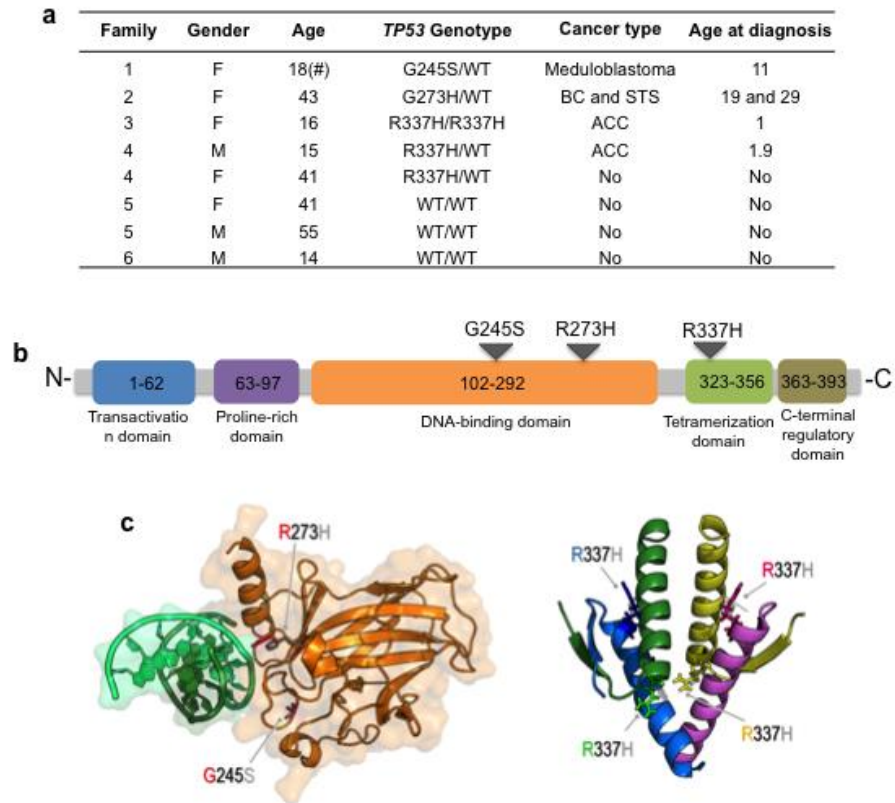

Figure 1. Clinical features of subjects and mutation location in carriers. (a) Patient information including family, gender, current age, genotype, cancer type and age at diagnosis. # indicate dead. Schematic diagram (b) and tridimensional structure (c) of p53 protein, indicating domains and mutations evaluated in this study (G245S, R273H and R337H).

Figure 2

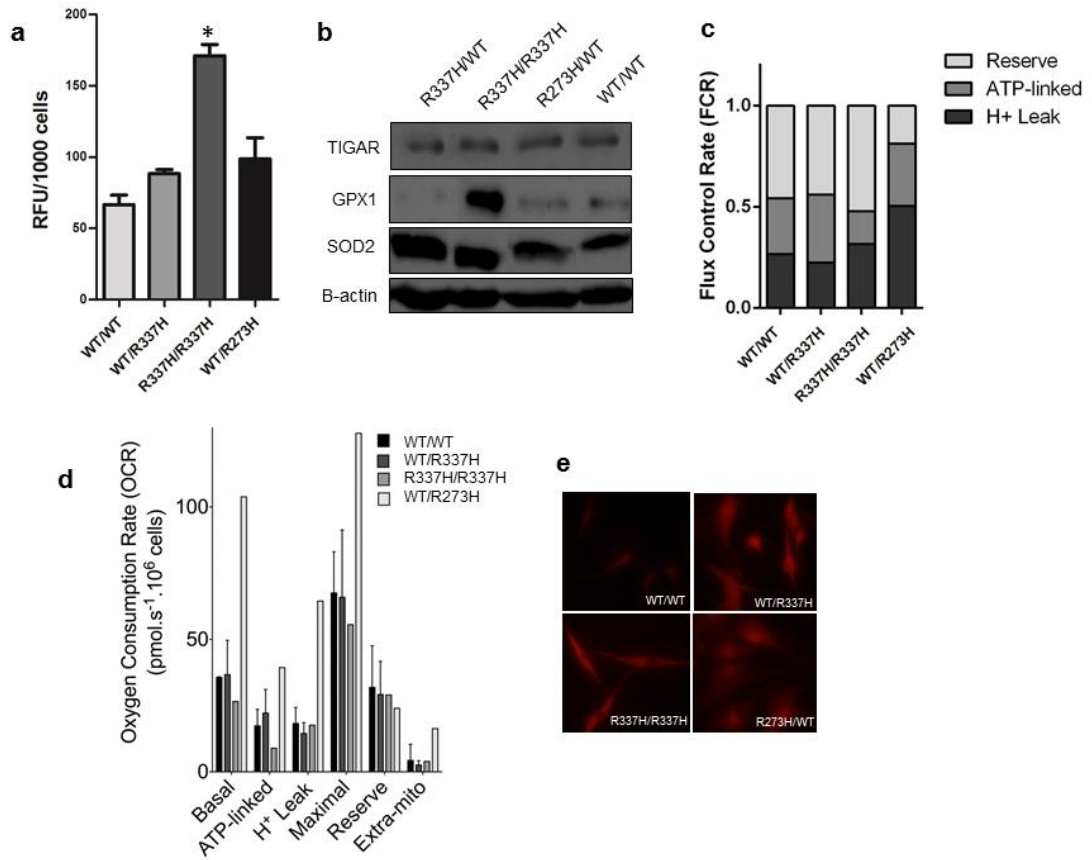

Figure 2. Mitochondrial physiology parameters. (a) ROS production. Each bar represents the mean \pm standard deviation for experiments performed in triplicate, * $P < 0.05$ (b) TIGAR, GPX1 and SOD2 expression in baseline conditions (c) Flux Control Rate (FCR) showing reserve, ATP-linked respiration as well as H⁺ leak (d) Panel showing the rates of oxygen consumption by fibroblasts controls (n=2), WT/R337H (n=2), R337H/R337H (n=1) and WT/R273H (n=1) (e) Immunostaining showing mitochondrial density in fibroblasts from subjects carrying different *TP53* mutations.

Figure 3

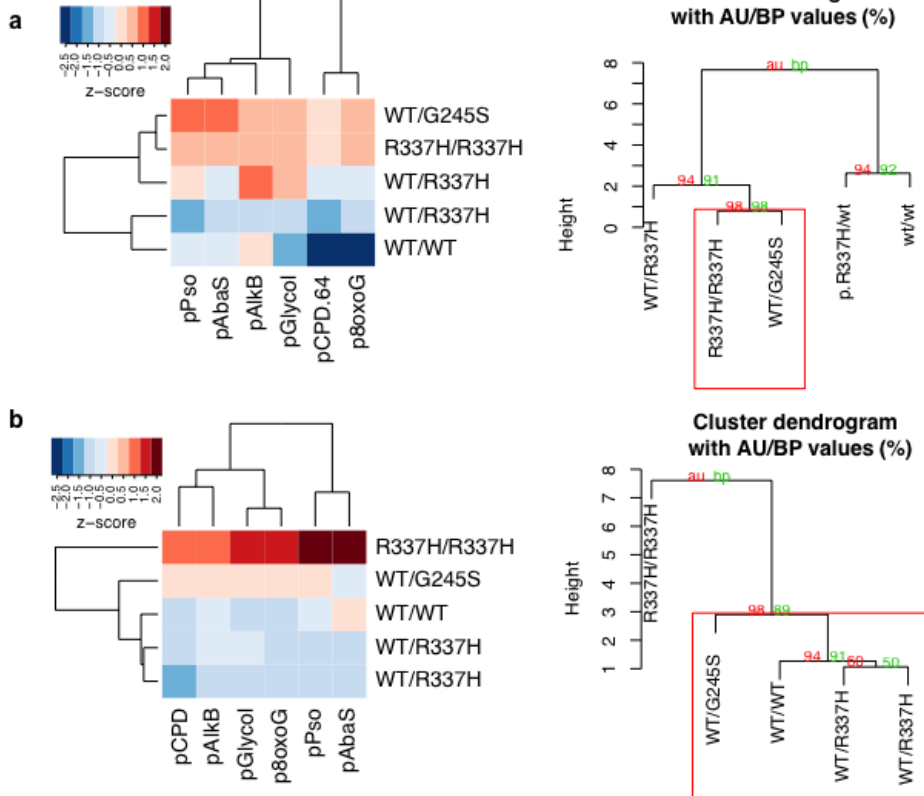

Figure 3. DNA damage response (Exy-SPOT). Heatmap and clustering analysis of Exy-SPOT assay showing DNA damage response after (a) UVB treatment (b) IR treatment. AU, Approximate Unbiased p-values; BP, Bootstrap Probability p-values.

Figure 4a

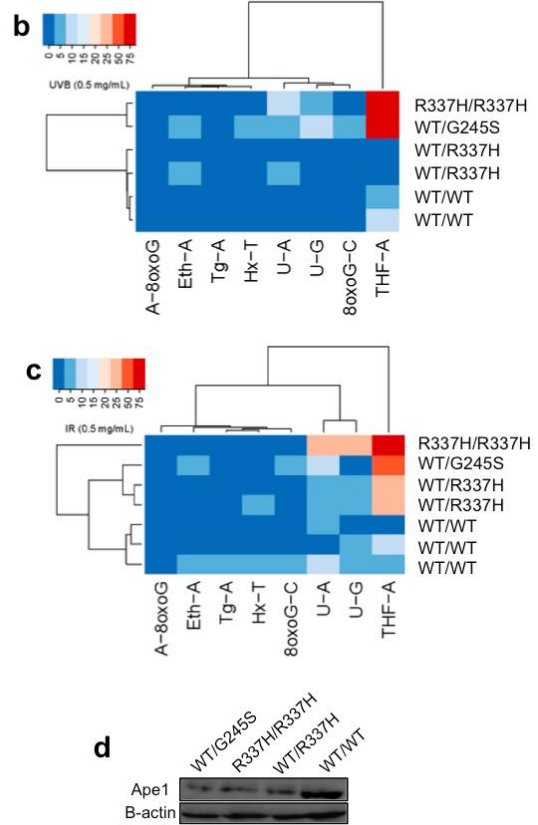
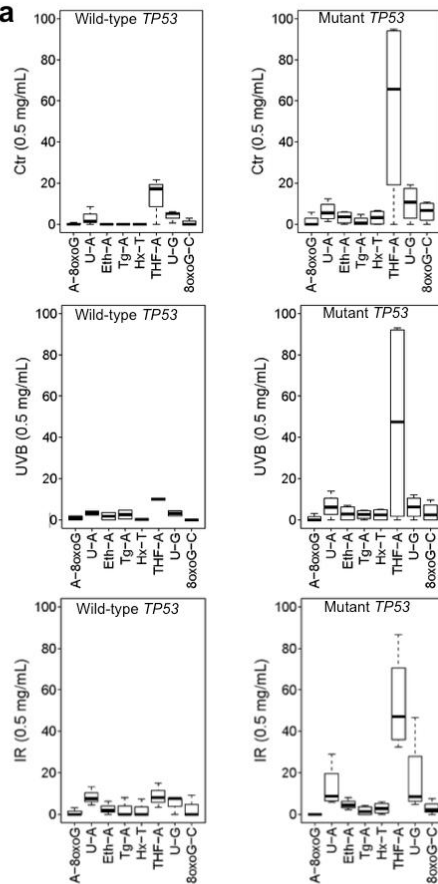

Figure 4. DNA damage response (Glyco-SPOT). (a) Box-plot showing the repair of different DNA lesions in wild-type and mutated p53 fibroblasts in nontreated and after UVB and IR treatment. Heatmap and clustering analysis of Glyco-SPOT assay showing DNA damage response after (b) UVB treatment (c) IR treatment. (d) Ape1 protein expression.

References

- 1 Malkin, D. *et al.* Germ line p53 mutations in a familial syndrome of breast cancer, sarcomas, and other neoplasms. *Science* **250**, 1233-1238 (1990).
- 2 Gonzalez, K. D. *et al.* Beyond Li Fraumeni Syndrome: clinical characteristics of families with p53 germline mutations. *J Clin Oncol* **27**, 1250-1256, doi:JCO.2008.16.6959 [pii] 10.1200/JCO.2008.16.6959 (2009).
- 3 Petitjean, A. *et al.* Impact of mutant p53 functional properties on TP53 mutation patterns and tumor phenotype: lessons from recent developments in the IARC TP53 database. *Hum Mutat* **28**, 622-629, doi:10.1002/humu.20495 (2007).
- 4 Evans, D. G. *et al.* Long-term outcomes of breast cancer in women aged 30 years or younger, based on family history, pathology and BRCA1/BRCA2/TP53 status. *Br J Cancer* **102**, 1091-1098, doi:10.1038/sj.bjc.6605606 (2010).
- 5 Giacomazzi, J. *et al.* Li-Fraumeni and Li-Fraumeni-like syndrome among children diagnosed with pediatric cancer in Southern Brazil. *Cancer* **119**, 4341-4349, doi:10.1002/cncr.28346 (2013).
- 6 Achatz, M. I. *et al.* The TP53 mutation, R337H, is associated with Li-Fraumeni and Li-Fraumeni-like syndromes in Brazilian families. *Cancer Lett* **245**, 96-102, doi:S0304-3835(06)00005-X [pii] 10.1016/j.canlet.2005.12.039 (2007).
- 7 Palmero, E. I., Achatz, M. I., Ashton-Prolla, P., Olivier, M. & Hainaut, P. Tumor protein 53 mutations and inherited cancer: beyond Li-Fraumeni syndrome. *Curr Opin Oncol* **22**, 64-69, doi:10.1097/CCO.0b013e328333bf00 (2010).
- 8 Custódio, G. *et al.* Impact of neonatal screening and surveillance for the TP53 R337H mutation on early detection of childhood adrenocortical tumors. *J Clin Oncol* **31**, 2619-2626, doi:10.1200/JCO.2012.46.3711 (2013).
- 9 Chène, P. The role of tetramerization in p53 function. *Oncogene* **20**, 2611-2617, doi:10.1038/sj.onc.1204373 (2001).
- 10 DiGiammarino, E. L. *et al.* A novel mechanism of tumorigenesis involving pH-dependent destabilization of a mutant p53 tetramer. *Nat Struct Biol* **9**, 12-16, doi:nsb730 [pii] 10.1038/nsb730 (2002).
- 11 Hainaut, P. Tumor-specific mutations in p53: the acid test. *Nat Med* **8**, 21-23, doi:nm0102-21 [pii] 10.1038/nm0102-21 (2002).
- 12 Vogelstein, B., Lane, D. & Levine, A. J. Surfing the p53 network. *Nature* **408**, 307-310, doi:10.1038/35042675 (2000).
- 13 Biegging, K. T., Mello, S. S. & Attardi, L. D. Unravelling mechanisms of p53-mediated tumour suppression. *Nat Rev Cancer* **14**, 359-370, doi:10.1038/nrc3711 (2014).
- 14 Hafsi, H. & Hainaut, P. Redox control and interplay between p53 isoforms: roles in the regulation of basal p53 levels, cell fate, and senescence. *Antioxid Redox Signal* **15**, 1655-1667, doi:10.1089/ars.2010.3771 (2011).

- 15 Kruiswijk, F., Labuschagne, C. F. & Vousden, K. H. p53 in survival, death and metabolic health: a lifeguard with a licence to kill. *Nat Rev Mol Cell Biol* 16, 393-405, doi:10.1038/nrm4007 (2015).
- 16 Vousden, K. H. & Ryan, K. M. p53 and metabolism. *Nat Rev Cancer* 9, 691-700, doi:nrc2715 [pii] 10.1038/nrc2715 (2009).
- 17 Wang, P. Y. et al. Increased oxidative metabolism in the Li-Fraumeni syndrome. *N Engl J Med* 368, 1027-1032, doi:10.1056/NEJMoa1214091 (2013).
- 18 Macedo, G. S. et al. Increased oxidative damage in carriers of the germline TP53 p.R337H mutation. *PLoS One* 7, e47010, doi:10.1371/journal.pone.0047010 (2012).
- 19 Wang, H. & Joseph, J. A. Quantifying cellular oxidative stress by dichlorofluorescein assay using microplate reader. *Free Radic Biol Med* 27, 612-616 (1999).
- 20 Halliwell, B. & Whiteman, M. Measuring reactive species and oxidative damage in vivo and in cell culture: how should you do it and what do the results mean? *Br J Pharmacol* 142, 231-255, doi:10.1038/sj.bjp.0705776 (2004).
- 21 Poot, M. et al. Analysis of mitochondrial morphology and function with novel fixable fluorescent stains. *J Histochem Cytochem* 44, 1363-1372 (1996).
- 22 Pesta, D. & Gnaiger, E. High-resolution respirometry: OXPHOS protocols for human cells and permeabilized fibers from small biopsies of human muscle. *Methods Mol Biol* 810, 25-58, doi:10.1007/978-1-61779-382-0_3 (2012).
- 23 Millau, J. F. et al. A microarray to measure repair of damaged plasmids by cell lysates. *Lab Chip* 8, 1713-1722, doi:10.1039/b806634e (2008).
- 24 Sauvaigo, S. et al. An oligonucleotide microarray for the monitoring of repair enzyme activity toward different DNA base damage. *Anal Biochem* 333, 182-192, doi:10.1016/j.ab.2004.06.046 (2004).
- 25 Suzuki, R. & Shimodaira, H. Pvclust: an R package for assessing the uncertainty in hierarchical clustering. *Bioinformatics* 22, 1540-1542, doi:10.1093/bioinformatics/btl117 (2006).
- 26 Zamin, L. L. et al. Protective effect of resveratrol against oxygen-glucose deprivation in organotypic hippocampal slice cultures: Involvement of PI3-K pathway. *Neurobiol Dis* 24, 170-182, doi:S0969-9961(06)00144-6 [pii] 10.1016/j.nbd.2006.06.002 (2006).
- 27 Bensaad, K. & Vousden, K. H. p53: new roles in metabolism. *Trends Cell Biol* 17, 286-291, doi:S0962-8924(07)00095-5 [pii] 10.1016/j.tcb.2007.04.004 (2007).
- 28 Matoba, S. et al. p53 regulates mitochondrial respiration. *Science* 312, 1650-1653, doi:10.1126/science.1126863 (2006).
- 29 Gottlieb, E. & Vousden, K. H. p53 regulation of metabolic pathways. *Cold Spring Harb Perspect Biol* 2, a001040, doi:10.1101/cshperspect.a001040 (2010).
- 30 Yonish-Rouach, E. et al. Induction of apoptosis by transiently transfected metabolically stable wt p53 in transformed cell lines. *Cell Death Differ* 1, 39-47 (1994).

- 31 Kuerbitz, S. J., Plunkett, B. S., Walsh, W. V. & Kastan, M. B. Wild-type p53 is a cell cycle checkpoint determinant following irradiation. *Proc Natl Acad Sci U S A* 89, 7491-7495 (1992).
- 32 Serrano, M., Lin, A. W., McCurrach, M. E., Beach, D. & Lowe, S. W. Oncogenic ras provokes premature cell senescence associated with accumulation of p53 and p16INK4a. *Cell* 88, 593-602 (1997).
- 33 Sablina, A. A. et al. *The antioxidant function of the p53 tumor suppressor.* *Nat Med* 11, 1306-1313, doi:nm1320 [pii] 10.1038/nm1320 (2005).
- 34 Mirzayans, R., Severin, D. & Murray, D. Relationship between DNA double-strand break rejoining and cell survival after exposure to ionizing radiation in human fibroblast strains with differing ATM/p53 status: implications for evaluation of clinical radiosensitivity. *Int J Radiat Oncol Biol Phys* 66, 1498-1505, doi:10.1016/j.ijrobp.2006.08.064 (2006).
- 35 Mirzayans, R., Andrais, B., Scott, A., Wang, Y. W. & Murray, D. Ionizing radiation-induced responses in human cells with differing TP53 status. *Int J Mol Sci* 14, 22409-22435, doi:10.3390/ijms141122409 (2013).
- 36 Zhou, P. K. et al. *The radiosensitivity of human fibroblast cell lines correlates with residual levels of DNA double-strand breaks.* *Radiother Oncol* 47, 271-276 (1998).
- 37 Brosh, R. & Rotter, V. When mutants gain new powers: news from the mutant p53 field. *Nat Rev Cancer* 9, 701-713, doi:10.1038/nrc2693 (2009).
- 38 Wong, K. B. et al. *Hot-spot mutants of p53 core domain evince characteristic local structural changes.* *Proc Natl Acad Sci U S A* 96, 8438-8442 (1999).
- 39 Camplejohn, R. S. et al. *A possible screening test for inherited p53-related defects based on the apoptotic response of peripheral blood lymphocytes to DNA damage.* *Br J Cancer* 72, 654-662 (1995).
- 40 De Moura, J. et al. *Heterozygous TP53stop146/R72P fibroblasts from a Li-Fraumeni syndrome patient with impaired response to DNA damage.* *Int J Oncol* 36, 983-990 (2010).
- 41 Boyle, J. M. et al. *Delayed chromosome changes in gamma-irradiated normal and Li-Fraumeni fibroblasts.* *Radiat Res* 157, 158-165 (2002).
- 42 Wiseman, H. & Halliwell, B. Damage to DNA by reactive oxygen and nitrogen species: role in inflammatory disease and progression to cancer. *Biochem J* 313 (Pt 1), 17-29 (1996).

Capítulo VI. Inflamação e efeito de substâncias antioxidantes sobre o fenótipo bioquímico de estresse oxidativo em portadores da mutação R337H.

Dados em preparação.

Os resultados apresentados nesta sessão da tese encontram-se em fase de análises laboratoriais e não serão apresentados no formato de artigo. No entanto, uma breve introdução sobre o tema, descrição de nossa hipótese de pesquisa, bem como os objetivos do estudo e resultados preliminares serão descritos, como segue abaixo. A discussão referente aos achados deste capítulo será apresentada na discussão final da tese (página 173).

Motivados pelo estudo de Sablina *et al.* (2005), que demonstrou pela primeira vez a função central de p53 na regulação do metabolismo celular redox, nós recentemente investigamos parâmetros de estresse oxidativo em plasma de indivíduos portadores da mutação R337H (denominado P) em comparação com indivíduos não portadores de mutações no gene *TP53* (denominado NP). Dentre os principais achados, foi demonstrado que o grupo P apresentava um aumento significativo no dano oxidativo tanto a proteínas ($P = 0.46 \pm 0.10$, NP = 0.23 ± 0.05 , $P = 0.035$) quanto a lipídios ($P = 160.5 \pm 0.88$, NP = 40.20 ± 0.71 , $P < 0.0001$) em relação ao grupo NP. Além disso, a investigação de parâmetros antioxidantes demonstrou que P apresentam baixa dosagem de ácido ascórbico ($P = 2.33 \pm 0.15$, NP = 3.84 ± 0.15 , $P < 0.0001$) e um aumento no conteúdo total de antioxidantes não enzimáticos ($P = 1.47 \pm 0.04$, NP = 1.30 ± 0.04 , $P = 0.007$), sugerindo uma resposta antioxidante adaptativa ao estresse metabólico. Estes achados foram independentes da história pessoal de câncer, indicando que as alterações encontradas são um efeito direto da mutação e não da manifestação da doença. Nossos resultados demonstraram, pela primeira vez, que uma mutação em *TP53* estava associada a uma perda da função antioxidante de p53, induzindo assim, um fenótipo bioquímico de estresse oxidativo. De maneira complementar, os resultados apresentados no capítulo V desta tese (estudo funcional da mutação R337H) confirmaram estes achados a nível celular.

Sendo assim, nosso objetivo neste estudo foi verificar o efeito da suplementação com diferentes substâncias antioxidantes (N-acetilcisteína, Coenzima Q10 e Idebenona) sobre o fenótipo bioquímico de estresse oxidativo identificado em portadores da mutação R337H. Para tanto, um estudo clínico do tipo randomizado, duplo-cego e placebo-controlado foi delineado. No total foram

recrutados 30 indivíduos, sendo 14 portadores da mutação R337H e 16 não portadores de mutações em *TP53*. Coletas de sangue periférico para isolamento de plasma foram realizadas antes e após o período de suplementação (14 dias). A fim de verificar o potencial efeito destas substâncias, biomarcadores de dano oxidativo a proteínas, como conteúdo de carbonilas e ácido ditionitrobenzóico (DTNB), e lipídios, incluindo conteúdo de malondialdeído (MDA) e ácido tiobarbitúrico (TBA-RS), foram avaliados nestes dois momentos.

Além disso, devido a bem descrita associação entre estresse oxidativo e inflamação, 30 marcadores inflamatórios, incluindo citocinas, quimiocinas e fatores de crescimento, foram dosados em plasma antes do início das suplementações.



Figura 1. Figura esquemática mostrando o delineamento do estudo. Parâmetros inflamatórios foram dosados apenas na coleta 1 e marcadores de estresse oxidativo nas coletas 1,2,3,4.

Tabela 1. Características clínicas dos indivíduos portadores da mutação R337H e controles recrutados para o estudo.

		R337H carriers (N=14)	Controls (N=16)
		Mean (Min - Max)	
Age		42,7 (20,1 - 63,8)	53,4 (22,7 - 73,8)
		N (%)	
Gender			
	Female	9 (64)	15 (94)
	Male	5 (36)	1 (6)
Previous cancer diagnosis			
	Yes	0 (0)	11 (69)
	No	14 (100)	5 (31)
Smoking			
	Never	12 (86)	11 (69)
	Current	0 (0)	0 (0)
	Past	2 (14)	5 (31)
In-use medications			
	Yes	12 (86)	13 (81)
	No	2 (14)	3 (19)
Affected by adverse effects			
	Phase I	8 (57) ¹	8 (50) ³
	Phase II	6 (43) ²	4 (25) ⁴
Adhesion (%)		Mean (Min - Max)	
	Phase I	95,2 (78 - 100)	93,8 (82 - 100)
	Phase II	92,7 (62 - 100)	94,1 (78 - 100)

(1) Six cases with effects possibly non-related to treatment; in one case the causal relation cannot be excluded, and in one case the relationship between treatment and effect was not described.

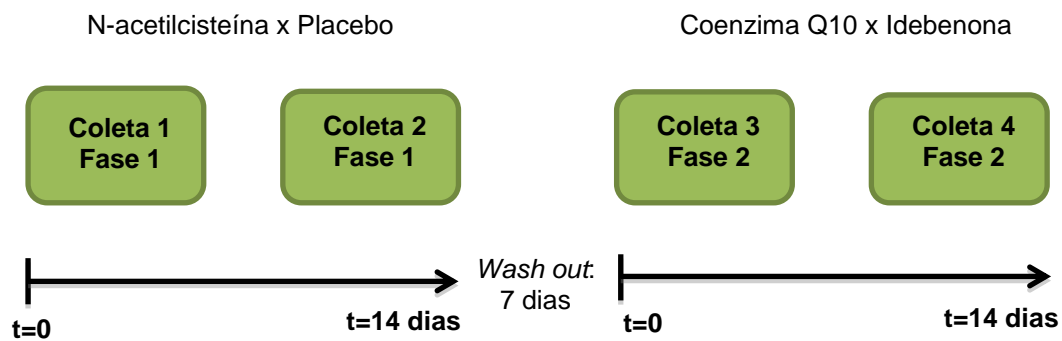
(2) Two patients with effects possibly non-related to treatment. Two patients did not attend to this phase.

(3) Four patients with effects possibly non-related to treatment and two with effects non-related to treatment. In two patients the causal relation cannot be excluded.

(4) Two patients without information regarding adverse effects. One patient had an adverse effect possibly related to treatment, and other one had an effect related to treatment. In two cases the relationship between treatment and effect was not described. One patient did not attend to this phase.

Tabela 2. Dosagens de citocinas, quimiocinas e fatores de crescimento em portadores da mutação R337H e controles.

Cytokines and growth factors	Controls	R337H carriers	<i>p</i> (Mann-Whitney Test)
	n=21 Median (IR 25-75)/ (Mean ± SD)	n=18 Median (IR 25-75)/ (Mean ± SD)	
FGF-Basic	7.20 (3.9-12-13)	9.69 (3.24-18.36)	0.352
IL-1b	7.83 (4.61-15.40)	7.82 (2.90-15.45)	0.685
G-CSF	136.2 ± 65.53	161.8 ± 60.28	0.226†
IL-10	11.46 (3.32-34.36)	11.60 (2.43-41.24)	0.789
IL-13	12.48 (11.30-21.24)	11.84 (8.10-36.06)	0.837
IL-6	4.16 (1.82-7.18)	4.89 (2.15-9.90)	0.573
IL-12	143.7 ± 46.07	202.7 ± 50.97	0.001*†
RANTES	1,300.78 (454.73-2,875.54)	11,487.30 (559.25-3,307.93)	0.398
EOTAXIN	33.19 (20-39.72)	28.14 (16.94-37.42)	0.499
IL-17	4.67 (3.56-8.30)	7.45 (4.77-11.69)	0.199
MIP-1a	39.56 (32.44-49.71)	45.07 (39.76-49.68)	0.155
GM-CSF	1.20 (0.56-6.32)	2.72 (0.43-14.26)	0.545
MIP-1b	52.07 (32.01-87.91)	54.35 (42.34-72.01)	0.899
MCP-1	225.41 (185.42-284.56)	241.33 (246.60-256.60)	0.888
IL-15	54.33 (25.99-95.73)	54.32 (37.21-118.26)	0.642
EGF	13.34 (6.85-21.92)	10.93 (9.24-27.26)	0.642
HGF	156.26 (108.62-190.77)	176.79 (120.38-263.30)	0.304
VEGF	3.74 (2.43-4.56)	3.51 (1.38-5.66)	0.579
IFN-γ	41.36 (19.64-50.17)	49.24 (34.51-51.99)	0.147
IFN-α	5.69 (3.40-7.93)	6.87 (5.66-8.56)	0.220
IL-1RA	121.57 (83.36-201.40)	140.34 (124.00-230.07)	0.176
TNF-α	3.72 (2.05-6.35)	3.85 (3.14-5.12)	0.455
IL-2	3.51 (2.57-6.25)	4.08 (3.26-9.53)	0.367
IP-10	21.83 (13.04-34.19)	21.70 (15.82-32.83)	0.778
IL-2R	179.84 (119.13-256.27)	193.51 (158.45-280.75)	0.266
MIG	74.58 (33.16-86.75)	66.23 (48.74-92.11)	0.978
IL-4	4.29 (2.66-6.49)	4.02 (2.99-6.42)	0.858
IL-8	9.59 (8.53-13.00)	11.77 (9.26-16.26)	0.091

IR Interquatile Range; p<0.05; † Student's T Test

Abaixo são apresentados os resultados da primeira fase do ensaio clínico (Fase 1) em que portadores e não portadores da mutação R337H foram randomizados quanto ao uso de N-acetilcisteína (900mg/dia) ou placebo (900mg/dia). Conforme mencionado anteriormente, conteúdo de carbonilas, DTNB, TBA-RS e MDA foram dosados antes e após 14 dias de suplementação.

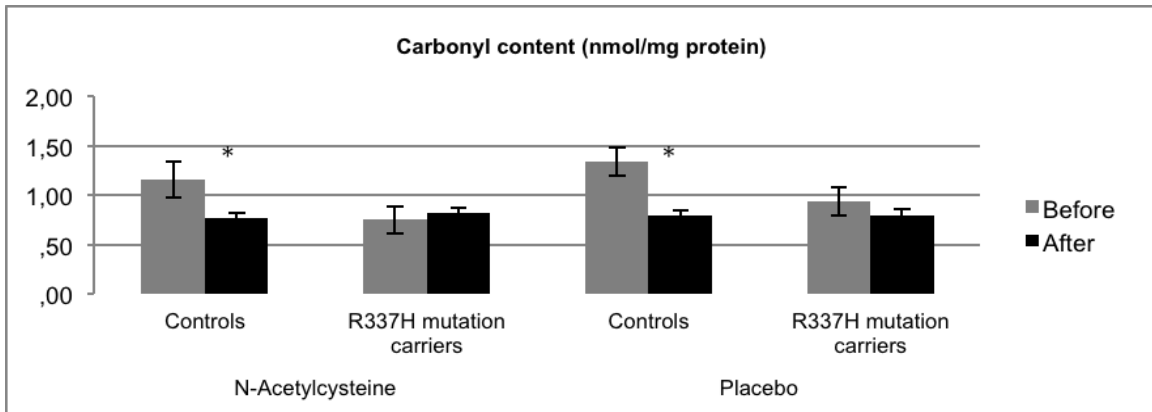

All data are expressed in mean ± standard error (SE) and the level of significance was set at 0.05. P<0.05 (*). Number of analyzed samples: Controls/NAC, n=9; R337H/NAC, n=7; Controls/Placebo, n=8; R337H/Placebo, n=6. Legend: before and after period of supplementation.

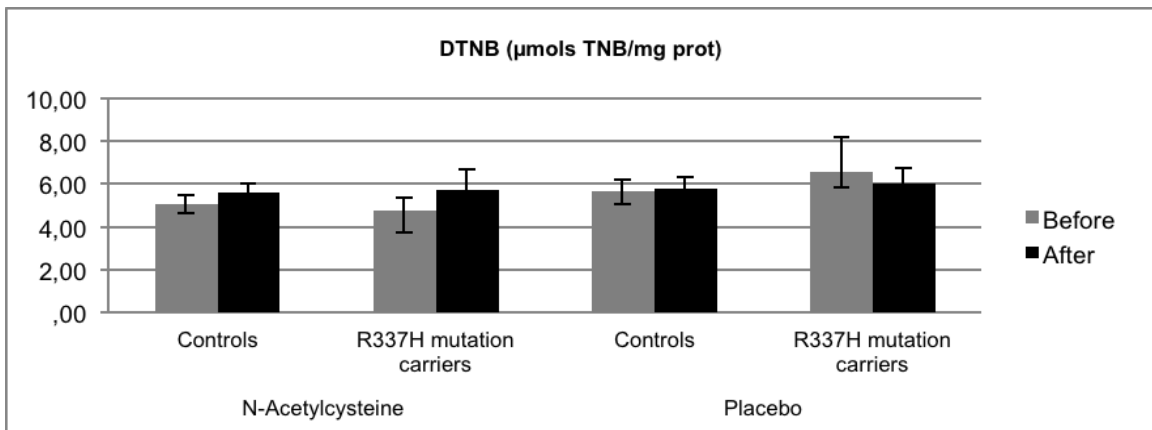

All data are expressed in mean ± standard error (SE) and the level of significance was set at 0.05. P<0.05 (*). Number of analyzed samples: Controls/NAC, n=9; R337H/NAC, n=7; Controls/Placebo, n=6; R337H/Placebo, n=7. Legend: before and after period of supplementation. DTNB, (5,5'-dithiobis-(2-nitrobenzoic acid).

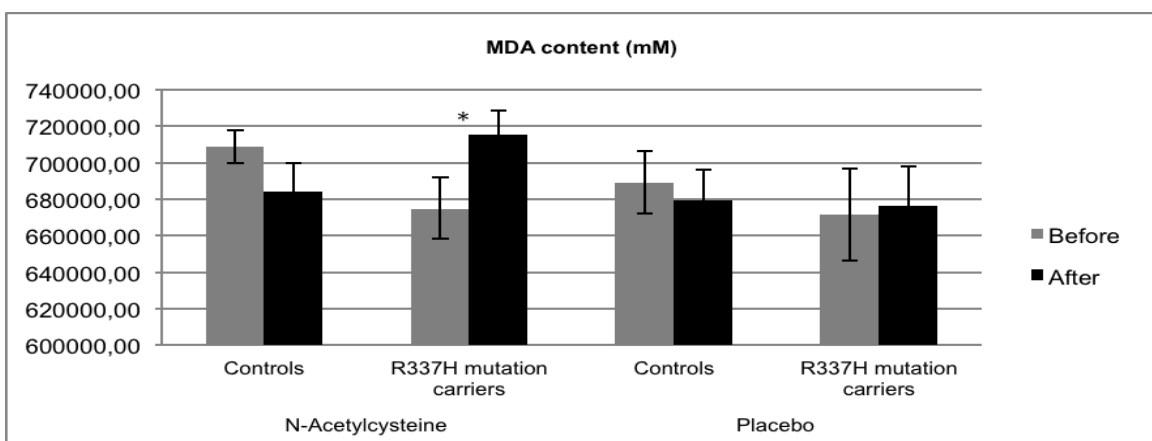

All data are expressed in mean ± standard error (SE) and the level of significance was set at 0.05. P<0.05 (*). Number of analyzed samples: Controls/NAC, n=8; R337H/NAC, n=7; Controls/Placebo, n=7; R337H/Placebo, n=7. Legend: before and after period of supplementation. MDA, Malondialdehyde.

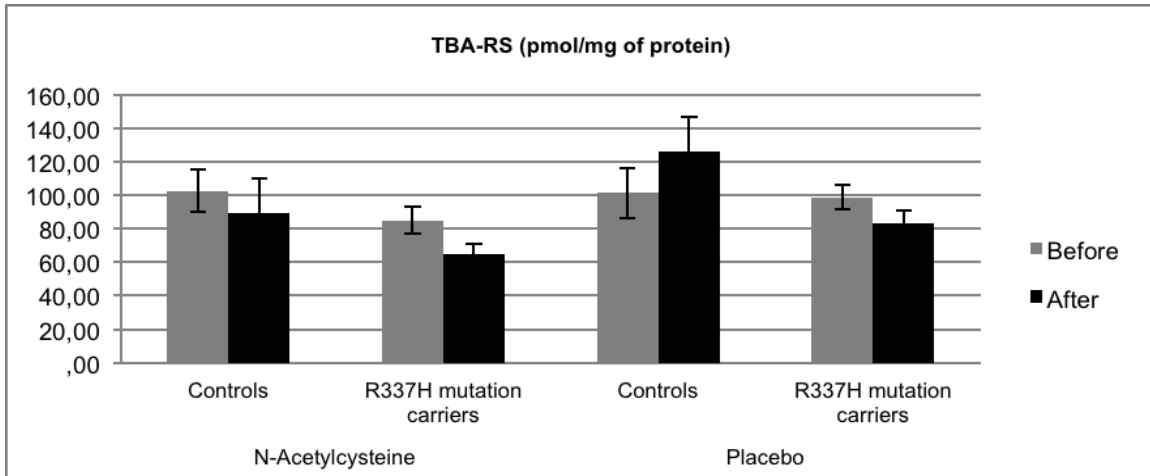

All data are expressed in mean \pm standard error (SE) and the level of significance was set at 0.05. $P < 0.05$ (*). Number of analyzed samples: Controls/NAC, n=9; R337H/NAC, n=6; Controls/Placebo, n=8; R337H/Placebo, n=7. Legend: before and after period of supplementation. TBA-RS, Thiobarbituric Acid Reactive Substances.

Na segunda fase do ensaio clínico (Fase 2) portadores e não portadores da mutação R337H foram randomizados quanto ao uso de Coenzima Q10 (1200mg/dia) ou Idebenona (900mg/dia). Da mesma forma que na primeira fase do estudo, conteúdo de carbonilas, DTNB, TBA-RS e MDA foram dosados antes e após 14 dias de suplementação.

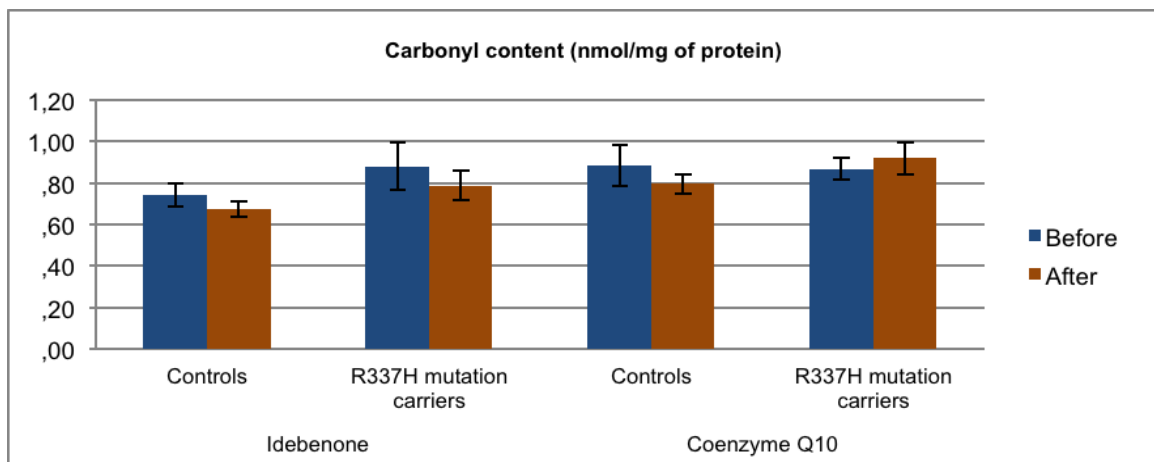

All data are expressed in mean \pm standard error (SE) and the level of significance was set at 0.05. $P < 0.05$ (*). Number of analyzed samples: Controls/Idebenone, n=6; R337H/Idebenone, n=5; Controls/Coenzyme Q10 n=8; R337H/Coenzyme Q10, n=7. Legend: before and after period of supplementation.

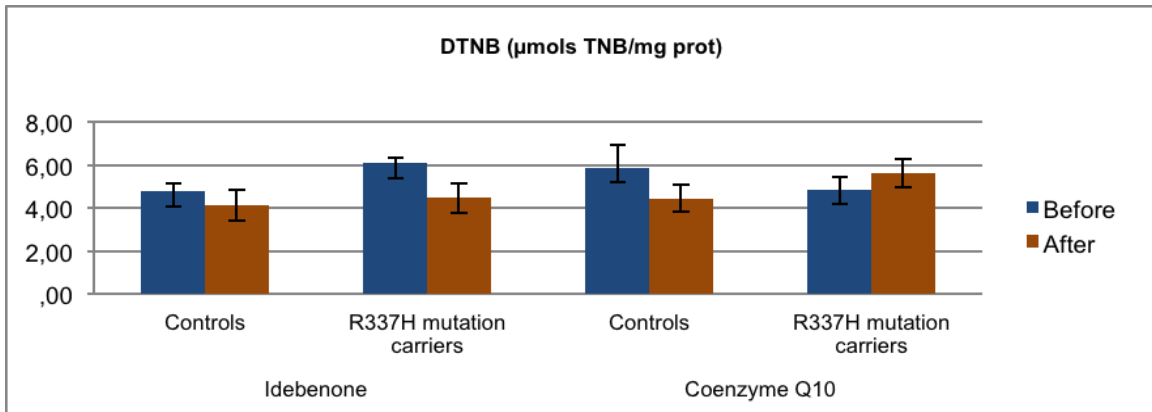

All data are expressed in mean \pm standard error (SE) and the level of significance was set at 0.05. $P < 0.05$ (*). Number of analyzed samples: Controls/Idebenone, $n=8$; R337H/Idebenone, $n=5$; Controls/Coenzyme Q10, $n=6$; R337H/Coenzyme Q10, $n=7$. Legend: before and after period of supplementation. DTNB, (5,5'-dithiobis-(2-nitrobenzoic acid)).

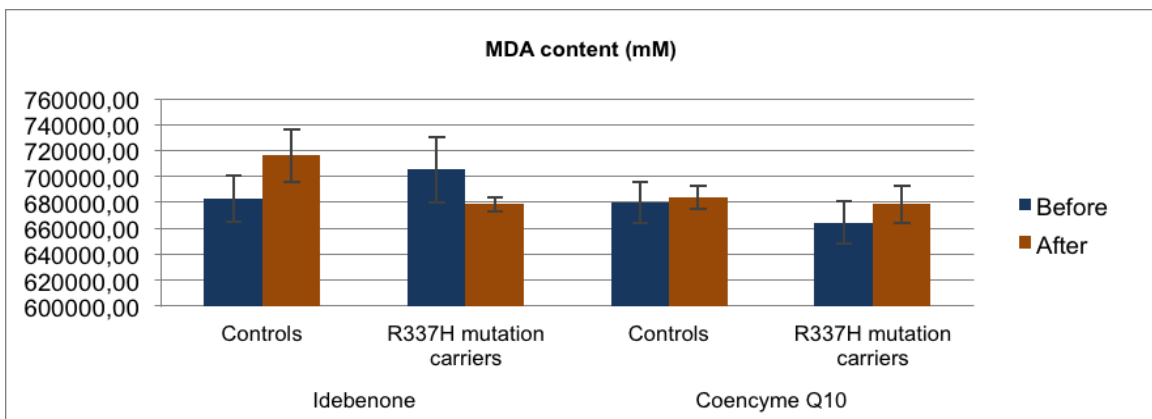

All data are expressed in mean \pm standard error (SE) and the level of significance was set at 0.05. $P < 0.05$ (*). Number of analyzed samples: Controls/Idebenone, $n=8$; R337H/Idebenone, $n=4$; Controls/Coenzyme Q10, $n=7$; R337H/Coenzyme Q10, $n=7$. Legend: before and after period of supplementation. MDA, Malondialdehyde.

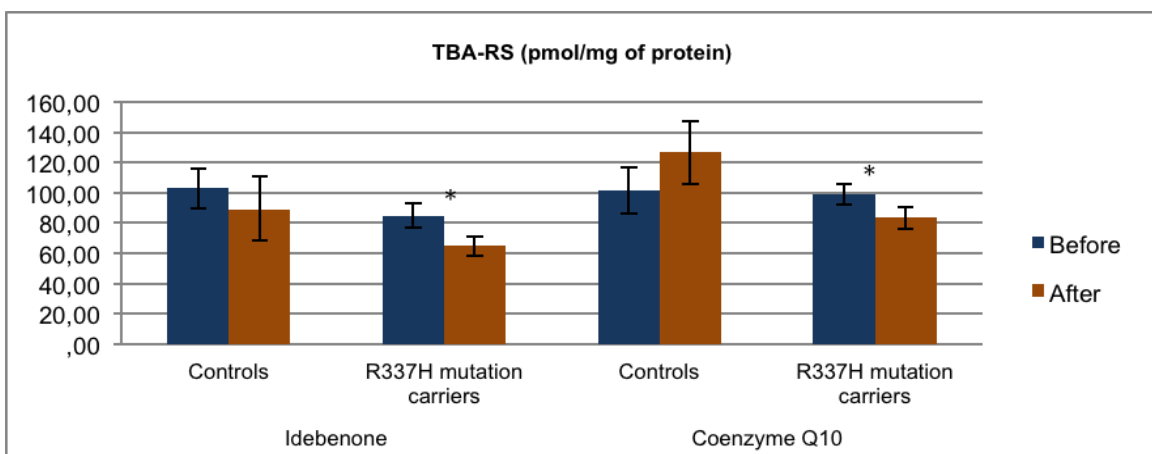

All data are expressed in mean \pm standard error (SE) and the level of significance was set at 0.05. $P < 0.05$ (*). Number of analyzed samples: Controls/Idebenone, $n=8$; R337H/Idebenone, $n=5$; Controls/Coenzyme Q10, $n=8$; R337H/Coenzyme Q10, $n=7$. Legend: before and after period of supplementation. TBA-RS, Thiobarbituric Acid Reactive Substances

Capítulo VII. Pathology of *BRCA1/2* and *PALB2* related cancer.

Artigo a ser publicado no periódico *Endocrine-related cancer* em 2016 (convite ao Dr. Jorge Reis-Filho).

Pathology of *BRCA1/2* and *PALB2* related cancer

Gabriel Macedo^{1,2} and Jorge S Reis-Filho^{1,3}

¹Department of Pathology, Memorial Sloan Kettering Cancer Center, New York, NY, USA

²Post-Graduate Program in Genetics and Molecular Biology, Universidade Federal do Rio Grande do Sul (UFRGS), Porto Alegre, 15053, Rio Grande do Sul, Brazil

³Human Oncology and Pathogenesis Program, Memorial Sloan Kettering Cancer Center, New York, NY, USA

Correspondence:

Dr. Jorge S Reis-Filho, Department of Pathology, Memorial Sloan Kettering Cancer Center, 1275 York Avenue, New York, NY 10065, USA. Phone: 212-639-8054; Fax: 212-639-2502; E-mail: reisfilj@mskcc.org

Conflict of interest: The authors have no conflicts of interest to declare.

Word count: 6.805

Abstract

Germline mutations in *BRCA1* and *BRCA2* (*BRCA1/2*) genes confer high risk of developing tumors, most notably breast and ovarian cancer. Since the cloning of these tumor suppressor genes more than two decades ago, a significant amount of research has been done. More recently, monoallelic loss-of-function mutations in *PALB2* (Partner and Localizer of *BRCA2*) have also been shown to increase the breast cancer risk. The recognition of *BRCA1*, *BRCA2* and *PALB2* as proteins involved in the DNA double-strand break repair by homologous recombination (HR) and of the impact of complete loss of *BRCA1/2* within tumors have allowed the development of novel therapeutic approaches for this subgroup of patients. Despite the advances, especially in the translation of PARP inhibitors to clinic, key gaps remain. Now, new roles for *BRCA1/2* are emerging and old concepts, such as the classical two-hit hypothesis for tumor suppression have been questioned, at least for some *BRCA* functions. Here we review aspects regarding the cancer predisposition, cellular functions, histological and genomic findings in *BRCA1/2* and *PALB2*-related tumors, as well as describe an up-to-date of the evolution and challenges faced by PARP inhibitors from bench to bedside.

BRCA1/2 and PALB2 genes: mutations and associated phenotypes

BRCA1/2 and PALB2-associated phenotypes

Hereditary Breast and Ovarian Cancer (HBOC) syndrome is a highly penetrant autosomal dominant disorder accounting for 5-7% of breast cancers (BCs) and 8-13% of epithelial ovarian cancers (EOCs), caused by germline mutations in either *BRCA1* or *BRCA2* genes (Liu, et al. 2012; Roy, et al. 2012). In *BRCA1* mutation carriers the average cumulative risks of breast and ovarian tumors by the age of 70 years is 65% and 39%, respectively, whereas in *BRCA2* mutation carriers the corresponding estimates are 45% and 11% (Antoniou, et al. 2003). Additionally, women who carry *BRCA1* germline mutations also have increased risk of developing fallopian tube and peritoneal cancers (Brose, et al. 2002; Finch, et al. 2006); men carrying *BRCA1* or *BRCA2* mutations have a higher risk of prostate cancer (Levy-Lahad and Friedman 2007); and patients with *BRCA1* or *BRCA2* mutations also may be at increased risk of pancreatic cancer (Consortium 1999; Ferrone, et al. 2009; Thompson, et al. 2002). More recently, monoallelic loss-of-function mutations in *PALB2* (Partner and Localizer of *BRCA2*) were found to confer predisposition to cancer, with a mean risk of BC in females of 35% by 70 years of age (Antoniou, et al. 2014; Rahman, et al. 2007). Based on data from different populations, *PALB2* germline mutations appear to account for approximately 1.1% of all familial aggregation of BC (Rahman et al. 2007). *PALB2* has also been reported as a susceptibility gene for pancreatic cancer (Jones, et al. 2009b; Slater, et al. 2010; Tischkowitz, et al. 2009).

BRCA1, *BRCA2* and *PALB2* germline mutations also contribute for risk of developing male breast cancer (MBC) (Levy-Lahad and Friedman 2007; Rahman et al. 2007; Thompson et al. 2002). Although corresponding for less than 1% of all BC cases, a significant proportion of MBCs arise in a setting of familial BC (Anderson and Badzioch 1992; Hemminki and Vaitinen 1999; Weiss, et al. 2005). Pathogenic germline mutations in *BRCA2* and *PALB2* have been found in 5-40% (Basham, et al. 2002; Ding, et al. 2011; Thorlacius, et al. 1997) and 1-2% (Ding et al. 2011), respectively, of all MBCs. On the other hand, the association between *BRCA1* germline mutations and MBC is not very well established, although several studies have demonstrated that *BRCA1* germline mutations may contribute to a

small fraction of MBC cases (Csokay, et al. 1999; Ottini, et al. 2009; Sverdlov, et al. 2000). Frank et al. reported *BRCA1/2* germline mutations in 28% of men with BC, of which a substantial proportion (8 of 22) occurred in *BRCA1* (Frank, et al. 2002).

Unlike what found in hereditary BC, in which monoallelic mutations are associated to increased predisposition to several tumors, another genetic disorder is caused by biallelic mutations in a set of DNA repair genes, including *BRCA1/2* and *PALB2* (Howlett, et al. 2002; Reid, et al. 2007; Sawyer, et al. 2015). Fanconi anemia (FA) is a rare recessive genetically heterogeneous chromosomal instability disorder characterized by congenital and developmental abnormalities and a for high predisposition to cancers (especially leukemia) (Tischkowitz and Hodgson 2003). FA is divided into several complementation groups according to mutated gene (Mathew 2006). Biallelic mutations in *BRCA2* (also referred as *FANCD1*) gene are identified in around 3-5% of FA cases and are associated to a high risk of very aggressive embryonal tumors in early childhood (mostly medulloblastomas and neuroblastomas) and/or acute leukemia (Meyer, et al. 2014; Reid, et al. 2005). The cumulative probability of any tumor in these patients was found to be of 97% by age 5.2 years (Alter, et al. 2007). Reid *et al.*, identified *PALB2* (also referred as *FANCM*) pathogenic mutations in families affected with FA and childhood cancer, characterizing a new subtype of the disease (Reid et al. 2007). More recently, it has been reported that biallelic *BRCA1* mutations also cause a Fanconi anemia-like phenotype (Sawyer et al. 2015).

BRCA1/2 and PALB2 mutations

Located on the long arm of chromosome 17 at 17q21 (Miki, et al. 1994), the *BRCA1* tumor suppressor gene is composed of 24 exons encoding for a protein of 1863 amino acids (Connor, et al. 1997; Teng, et al. 2008). *BRCA2* gene maps to chromosome 13 (13q12.3) (Connor et al. 1997) and consists of 27 exons coding for 3418 amino acids (Tavtigian, et al. 1996). The largest exon in both genes is exon 11, which harbors the vast majority of the mutations identified in patients with BC. Most of them are frameshift mutations resulting in missing and nonfunctional proteins (Al-Mulla, et al. 2009).

The overall prevalence of *BRCA1/2* mutation carriers is estimate to be from 1 in 400 to 1 in 800, but varies considerably between ethnic groups (Whittemore et al. 1997; Ford et al. 1995). For instance, in the Ashkenazi Jewish population two common mutations in the *BRCA1* gene (c.68_69delAG, formerly known as 185delAG, and c.5266dupC, also known as 5382insC) and one common mutation in *BRCA2* gene (c.5946delT, formerly known as 6174delT) are highly prevalent (approximately 2%) (Gabai-Kapara, et al. 2014; Struewing, et al. 1997). The most common types of deleterious mutation found in *BRCA1/2* are small frameshift deletions or insertions, nonsense and splice site mutations (Borg, et al. 2010). Interestingly, the genomic regions of both *BRCA1* and *BRCA2* genes are composed by a very high density of repetitive DNA elements, comprising approximately 47% of *BRCA1* (42% Alu sequences and 5% non-Alu repeats) and *BRCA2* (20% Alu and 27% LINE and MER repetitive DNA) sequence (Welcsh and King 2001). Given these characteristics, it is not surprising that Alu-mediated genomic rearrangements within both genes have been observed. Nevertheless, large rearrangements have been estimated to occur in 0-40% of carriers, depending of the population, and should be investigated when initial sequencing analysis not sensitive for their detection are reported as negative (Ewald, et al. 2009).

A large number of rare germline variants has been reported throughout both genes according to the Breast Cancer Information Core website (BIC) (approximately 1800 mutations in *BRCA1* and 2000 mutations in *BRCA2*), and the vast majority have not been reported as recurrent (Breast Cancer Information Core; www.research.nhgri.nih.gov/bic). Moreover, in the absence of any clearly pathogenic variant, around 15% of DNA sequencing of the *BRCA1 and BRCA2 genes result in the identification of Variants of Uncertain Significance (VUS)*, which include missense changes, small in-frame deletions or insertions, as well as alterations in non-coding or in untranslated regions (Plon, et al. 2008). Identification of VUS has become a major challenge when tailoring genetic counseling and disease prevention strategies related to HBOC syndrome (Cheon, et al. 2014).

The spectrum of *PALB2* mutations is similar to that found in *BRCA1* and *BRCA2* genes, in which protein truncating mutations are distributed throughout the coding regions. However, in contrast to its partners, there is no evidence of the pathogenicity of missense mutations and their role in BC predisposition (Southey, et al. 2013). Interestingly, in the Finnish population only one single mutation in *PALB2* was described (c.1592delT). This founder mutation occurs in 0.2% of the general population and it is associated with a 6-fold increased risk of BC (Erkko, et al. 2008; Erkko, et al. 2007; Haanpää, et al. 2013).

Biological functions and impact of mutations

BRCA1/2 and PALB2 functions

Few years after the discovery of *BRCA1* and *BRCA2* genes, many studies were able to show aspects regarding the physical and functional interactions made by BRCA proteins in several biological processes, especially in the DNA damage response and maintenance of the chromosomal stability (Venkitaraman 2001). Although *BRCA1* and *BRCA2* have clearly different biochemical functions, the precise mechanisms by which these proteins protect chromosome integrity is not completely understood. The differences in terms of intracellular localization during the cell cycle, the complexity of partners that have been reported to interact with BRCA proteins and the dynamic nature of these properties according to cellular signals suggest that *BRCA1* and *BRCA2* belong to a subset of proteins that work as “hubs” (Venkitaraman 2014). More recently, the functional interaction of *PALB2* and BRCA proteins as well as its role in DNA damage response has been partially revealed (Xia, et al. 2006; (Sy, et al. 2009)

The protein products of the *BRCA1* and *BRCA2* genes have been recognized as crucial for an effective DNA repair of double-strand breaks (DSBs) (Moynahan, et al. 1999; Moynahan, et al. 2001). DSB is one of the most cytotoxic types of DNA damage and potentially trigger genome rearrangements and cell death (Stracker, et al. 2013). The DSB repair is mainly played by homologous recombination (HR) and nonhomologous end-joining (NHEJ), two DNA repair pathways differentially regulated depending on the phase of the cell cycle and nature of the damage (Burma, et al. 2006; Mao, et al. 2008; Sonoda, et al. 2006).

HR, a vital DNA repair pathway that uses the undamaged sister chromatid to repair replication-associated DSBs, is a largely error free pathway especially important during the S and G2 phases of the cell cycle. HR involves proteins (e.g ATM/ATR) that can detect broken ends (sensors), repair the damage (e.g BRCA2 and RAD51) (effectors) and connect both (e.g CHK2 and BRCA1) (mediators) (Roy et al. 2012). PALB2 is immediately downstream of BRCA1 and it has been shown to be required for efficient DNA repair by HR and also as a linker between BRCA1 and BRCA2 (Zhang, et al. 2009). PALB2 absence prevents recruitment of BRCA2 and RAD51 to the DSBs site (Sy et al. 2009; Xia, et al. 2006).

In addition to HR, NHEJ DNA repair pathway may be activated as an alternative mechanism of DSBs repair (Brandsma and Gent 2012). NHEJ is active throughout the cell cycle (favored in G1 cell) and promotes direct ligation of the DSB ends, but in an error-prone manner, frequently resulting in small insertions, deletions and translocations (Lieber 2010). Although there are conflicting results concerning the role of BRCA1 in the NHEJ, this DNA repair pathway has been reported to be unaffected in a BRCA1-deficiency context (Baldeyron, et al. 2002; Gudmundsdottir and Ashworth 2006). This may be due, at least in part, to the differential involvement of this protein in the NHEJ subpathways. Some studies support the promoting role of BRCA1 in precise NHEJ, while being a negative regulation of error-prone NHEJ (Wang, et al. 2006). So far, it seems that BRCA2 and PALB2 are not required for NHEJ DNA repair (Metzger, et al. 2013; Xia, et al. 2001).

It's remarkable that BRCA1/2 and PALB2-deficient cells exhibit spontaneously single sister chromatid breaks, quadri and triradial chromosomes as well as translocations, large deletions, and fusions involving non-homologous chromosomes (Moynahan 2002; Nikkilä, et al. 2013; Shen, et al. 1998; Yu, et al. 2000). Mostly important, DSBs seem to be the typical structural aberrations found in BRCA-deficient cells, suggesting that HR is important for tumor suppression (Venkitaraman 2014). Thus, cells that lack either BRCA1/2 or PALB2 repair the lesions by a error-prone mechanism, such as NHEJ (Obermeier, et al. 2015; Tutt, et al. 2005). This shift is in agreement with aneuploid features and frequently compromised chromosome segregations found in the cells (Venkitaraman 2014).

Taken together, these data revealed that BRCA and PALB2 proteins play an important role in the maintenance of genomic stability, wherein deficiency of these proteins promotes chromosomal instability and carcinogenesis.

More recently, based on the broad variability of abnormalities found in BRCA knockout and mutated cells, several new functions for *BRCA1* and *BRCA2* genes have emerged. BRCA1 has been implicated in the mitotic spindle-pole assembly, via BRCA1/BARD1 complex. The potent ubiquitin E3 ligase activity of this interaction seems to be fundamental for TPX2 accumulation, a major spindle organizer. This previously unrecognized function likely contributes to its chromosome stability control and tumor suppression (Joukov, et al. 2006). Inactivation of BRCA2 also leads to weakened spindle assembly and aneuploidies, suggesting a role of BRCA2 in the spindle assembly checkpoint and kinetochore stability (Choi, et al. 2012). Moreover, BRCA2 also seems to protect the length of nascent strand of DNA from degradation at stalled replication forks, since BRCA2-deficient hamster cells show newly synthesized DNA strands substantially shorter compared to wild-type *BRCA2* cells (Schlacher, et al. 2011). Several other studies have also suggested a role for BRCA proteins in chromatin remodeling (Ye, et al. 2001), gene expression (Hill, et al. 2014), telomere protection (Badie, et al. 2010; French, et al. 2006) and heterochromatin maintenance (Zhu, et al. 2011). However, whether these emerging BRCA function are required for tumor suppression is unknown.

The two-hit model of carcinogenesis

Over 40 years ago, Alfred Knudson proposed a model of carcinogenesis in which recessive mutations in a tumor suppressor gene are required for tumor development (also called Knudson's "Two Hit" Hypothesis) (Knudson 1971). Although this has been accepted for many years, recent new data have shown that inactivation of both alleles may not be a rate-limiting step for some tumor suppressor genes (Berger, et al. 2011). Haploinsufficiency is one of the mechanisms that may explain phenotypes arising in tumors or normal cells heterozygous for such mutations. This phenomenon characterized by reduction in the gene dosage lead to changes of cellular process that may contribute to

tumorigenesis (Santarosa and Ashworth 2004). In agreement with the Knudson hypothesis, seminal studies in mice model showed that complete *Brca1*, *Brca2* and *Palb2* deficiency results in early embryonic lethality. Interestingly, *Brca1*, *Brca2* and *Palb2* heterozygous mice could not be distinguished from wild-type, corroborating the classic recessive model for tumor suppression, at least in animal models (Gowen, et al. 1996; Rantakari, et al. 2010; Sharan, et al. 1997).

In contrast to mice, women heterozygous for *BRCA1/2* and *PALB2* germline mutations are predisposed to several tumors (Antoniou et al. 2003; Antoniou et al. 2014; Liu et al. 2012; Roy et al. 2012) and biallelic mutations in these genes result in Fanconi anemia (Howlett et al. 2002; Reid et al. 2007; Sawyer et al. 2015). Although *BRCA1/2* and *PALB2* have been considered *bona fide* tumor suppressor genes, whose complete loss-of-function due to loss, mutation or gene promoter methylation of the wild-type allele is required for carcinogenesis (Ashworth, et al. 2011; Bowman-Colin, et al. 2013; Narod and Foulkes 2004), new evidence has challenged this notion and demonstrated that heterozygote mutations in these genes may have an impact in cellular biology, affecting DNA repair function and perhaps enabling the development of tumors in humans. Moreover, it is still unclear whether inactivation of the wild-type allele is essential for tumor initiation or occurs stochastically.

Several studies have shown that although loss of the wild-type allele (loss of heterozygosity, LOH) is common in *BRCA*-BCs, not all breast tumors display such characteristic, suggesting that at least a subset of the *BRCA1/2*-mutated BCs can develop in absence of LOH (Martins, et al. 2012; Osorio, et al. 2002; Palacios, et al. 2003; Stefansson, et al. 2011; Tung, et al. 2010). On the other hand, conflicting data for *PALB2*-BCs have been reported. Most data focused on the presence of *PALB2* deletions, however whether the wild-type *PALB2* allele may be silenced through the presence of mutations, somatic rearrangements or epigenetic events remains to be fully established (Casadei, et al. 2011; Erkkö et al. 2007; García, et al. 2009; Hartley, et al. 2014; Tischkowitz, et al. 2007; Tsuda, et al. 1995). Although the reason for disparities between mice and humans is still unknown, the short lifespan, low rate of LOH and the tissue-specific

haploinsufficiency observed in mice may explain these differences (Drost and Jonkers 2009).

Regardless whether loss of the wild-type allele is required or not for BRCA and PALB2-linked tumorigenesis, a number of studies have supported haploinsufficiency for specific phenotypes associated with these genes (Buchholz, et al. 2002; Lim, et al. 2009; Nikkilä et al. 2013). Some data indicate that normal mammary epithelial cells (MEC) from heterozygous for *BRCA1/2* mutations show increased ability for clonal growth, altered differentiation properties and aberrant expression profiles (Bellacosa, et al. 2010; Burga, et al. 2009; Feilotter, et al. 2014; Lim et al. 2009; Proia, et al. 2011). Moreover, supporting haploinsufficiency phenotype, King et al. identified partial or complete LOH involving the mutant rather than wild-type allele in normal epithelium from *BRCA1* and *BRCA2* mutation carriers, possibly due to higher susceptibility to mitotic recombination within of these cells (King, et al. 2007). In a study published recently (Pathania, et al. 2014), a comprehensive analysis using a collection of wild-type versus heterozygous mutant *BRCA1* MECs and fibroblasts have provided clues regarding the biological mechanisms of haploinsufficiency. It was demonstrated that all heterozygote mutant *BRCA1* cells exhibited multiple normal *BRCA1* functions, including the support of homologous recombination-type double-strand break repair, checkpoint functions, centrosome number control and spindle pole formation. However, these cells exhibited innate haploinsufficiency in their ability to support stalled fork repair and to prevent replication stress. In contrast, Martins et al. have identified centrosome abnormalities in the normal breast tissue from *BRCA1* mutations carriers (Martins et al. 2012). Moreover, Konishi et al. demonstrated *in vitro* and *in vivo* that heterozygous *BRCA1* mutation confers impaired homology-mediated DNA repair and hypersensitivity to genotoxic stress in MECs. Additional results also revealed higher gene copy number losses and genomic instability in these cells when compared with their respective controls (Konishi, et al. 2011). Thus, these findings suggest that haploinsufficiency of BRCA1 may accelerate carcinogenesis by facilitating additional genetic alterations. Recently, Savage *et al.* showed that transcription of the *CYP1A* gene, which encodes an estrogen-metabolizing enzyme, is upregulated in *BRCA1* heterozygous cells. In addition, it

was demonstrated that estrogen and estrogen metabolites result in increased DNA DSBs in *BRCA1* heterozygous cells. Altogether, these data suggest that *BRCA1* haploinsufficiency could result in DNA damage in tissues under estrogen stimulation and provide some clues regarding why breast and ovarian tissues are mostly affected by tumors (Savage, et al. 2014).

In contrast to *BRCA1*, much less is known about biological mechanisms associated with *BRCA2* and *PALB2* monoallelic mutations. Arnold *et al.*, using lymphoblastoid cell lines, have shown lower amounts of the full-length *BRCA2* protein in *BRCA2* heterozygote cells compared to *BRCA2* wild-type. This dosage effect of *BRCA2* protein was correlated with an increase in DNA DSBs and an impaired repair of these lesions (Arnold, et al. 2006). For some mutations (e.g. truncal mutations) lower amounts of *BRCA2* protein also lead to increased chromosomal rearrangements and higher rates of sister chromatid exchanges, indicating a higher susceptibility of *BRCA2* heterozygous cells to chromosomal abnormalities (Kim, et al. 2004; Savelyeva, et al. 2001). Finally, defects in recruiting *RAD51* to DSBs sites and activating HR also have been reported in *BRCA2*-deficient cells (Yuan, et al. 1999). In a study published by Nikkila *et al.*, low levels of *PALB2* protein, aberrant DNA replication/damage response, as well as elevated chromosome instability was observed in the *PALB2* heterozygote state (Nikkila, et al. 2013). Moreover, haploinsufficiency of the suppression of error-prone DSB repair, but not reduced HR activities, nor impaired *RAD51* filament assembly has been observed in *PALB2* mutation carriers (Obermeier *et al.* 2015).

Taken together, these findings show that heterozygosity for *BRCA1/2* and *PALB2* mutations may impair different biological mechanisms. Although the impact of these alterations on carcinogenesis remains unknown, these detectable effects of "one hit" potentially represent early molecular changes in tumorigenesis. However, these findings remain inconclusive since most of studies used small number of samples and non-isogenic cell lines.

Tumor phenotype and genomic landscape of *BRCA1/2* and *PALB2*-associated tumors

Histology and Immunophenotype

Invasive ductal carcinoma is the most common histological type of BRCA1 and BRCA2 related breast tumors (Honrado, et al. 2005). Other histological subtypes, including medullary and tubular carcinoma are also found in this subgroup of patients (Mavaddat et al. 2012; Marcus, et al. 1996; Eisinger, et al. 1998). A more detailed examination of morphologic features of these tumors have shown that when compared to sporadic BCs, BRCA1 tumors exhibited higher mitotic counts, more lymphocytic infiltration and greater proportion of the tumor with a continuous pushing margin. On the other hand, BRCA2 tumors are less homogeneous, though exhibiting a higher score for tubule formation, higher proportion of the tumor perimeter with a continuous pushing margin, and a lower mitotic count than sporadic BCs (Lakhani, et al. 1998). The vast majority of BRCA1 tumors are poorly differentiated (grade 3), while BRCA2 tumors are usually moderately (grade 2) or poorly (grade 3) differentiated (Agnarsson, et al. 1998; Lynch, et al. 1998; Palacios et al. 2003).

With regard to pre-invasive lesions, although originally it has been postulated that BRCA1/2-associated BCs show less frequently ductal carcinoma in situ (DCIS) and lobular carcinoma in situ (LCIS) compared to sporadic breast cancer (1997; Arun, et al. 2009; Hoogerbrugge, et al. 2006), results from prophylactic mastectomies indicate that BRCA1/2 tumors have similar or higher frequency of premalignant lesions (Hoogerbrugge, et al. 2006; Isern, et al. 2008; Kauff, et al. 2003).

Despite being driven by germline mutations in functionally related genes, *BRCA1*, *BRCA2* and *PALB2* mutated breast cancers (herein called “BRCA1 tumors”, “BRCA2 tumors” and “PALB2 tumors”) constitute a heterogeneous group of tumors at the immunohistochemical and molecular level (**Table 1**). In a way akin to the morphological findings, at least 70% of the tumors arising in *BRCA1* mutation carriers display a triple-negative phenotype (estrogen receptor (ER)-negative, progesterone receptor (PR)-negative and human epidermal growth factor 2 (HER2)-negative), and are classified as basal-like molecular subtype according to immunohistochemical and microarray data (Badve, et al. 2011; Mavaddat, et al. 2012; Sorlie, et al. 2003). In contrast, BRCA2 tumors have been

classified predominantly as hormone receptor-positive (Mavaddat et al. 2012; Melchor, et al. 2008). A significant proportion of these tumors show unclassified subtype, with intermediate characteristics between Luminal A and B subtypes (Melchor et al. 2008). Furthermore, several reports have shown similar prevalence of ER- and PR-positive disease in *BRCA2* carriers compared with sporadic controls (Armes, et al. 1999; Palacios, et al. 2005). Regarding *PALB2* tumors, a study conducted by Heikkinen et al. found that breast tumors arising in patients carrying a Finnish founder mutation in *PALB2* (c.1592delT) are more likely to have triple-negative phenotype when compared to non-*PALB2* mutation-associated breast cancers. Additionally, these tumors were more often of higher grade, had greater expression of Ki-67 and were associated to reduced survival (Heikkinen, et al. 2009). In the majority of cases, however, the clinical phenotype of *PALB2*-BC resembles that of *BRCA2*-BC, as both are predominantly ER- and PR-positive (Antoniou et al. 2014; Bane, et al. 2007; Cybulski, et al. 2015; Nguyen-Dumont, et al. 2015; Teo, et al. 2013; Tischkowitz et al. 2007). Moreover, minimal sclerosis was identified as a predictor of germline *PALB2* mutation status, distinguishing *PALB2* mutation carriers from *BRCA1* and *BRCA2* mutation carriers (Teo et al. 2013).

In addition to a triple-negative phenotype and expression of basal markers, *BRCA1* tumors are characterized by high proliferation rate (Foulkes, et al. 2003; Lakhani, et al. 2005). Overexpression of proteins associated to cell cycle progression (cyclin E, A and B1) as well as low expression of cyclin D1 and cyclin-CDK complex inhibitors such as p16, p27 and p21 has also been observed (Chappuis, et al. 2005; Honrado, et al. 2006; Palacios et al. 2005). Unlike *BRCA1* tumors, *BRCA2* tumors seem to be characterized by higher expression of cell cycle proteins, including cyclin D1, cyclin D3, p27, p16, p21, CDK4, CDK2 and CDK1 (Palacios et al. 2005). A recent study found that *BRCA* tumors are usually positive for PARP1 (non-cleaved), possibly stimulated by DNA breaks and *BRCA* deficiency. Lower expression of RAD51 and BARD1, two key component of DNA damage repair by HR, were also found in *BRCA1* and *BRCA1/2* tumors, respectively, when compared with sporadic BCs (Aleskandarany, et al. 2015). *PALB2* BCs are not different from other breast tumors regarding cytokeratin 5/6

and 17 expression, but show higher expression of Ki-67 and lower cyclin D1 than other familial and sporadic BCs (Heikkinen et al. 2009).

Link between BRCA1 and ER status

Despite the evident association between BRCA1 tumors and triple-negative phenotype, the complete mechanisms underlying this correlation are still unclear. Findings of *in vitro* studies have suggested that BRCA1 directly modulates ER expression in BC, and that BRCA1 deficiency would result in ER-negative phenotype (Gorski, et al. 2009; Hosey, et al. 2007). Furthermore, there is evidence showing that the differentiation status of breast stem cells may be regulated by BRCA1 and that these breast tumors originate from ER-negative luminal progenitor cells (Lim et al. 2009; Molyneux, et al. 2010). However, at least 20% of all breast tumors arising in *BRCA1* germline mutation carriers express ER (Mavaddat et al. 2012). Some authors argue that these cancers are not linked to *BRCA1* germline mutations, but most likely constitute sporadic ER-positive tumors (Tung et al. 2010). In contrast, Natrajan et al. using whole genome massively parallel sequencing showed that ER-positive and ER-negative *BRCA1* cancers share a very similar genomic landscape, suggesting that at least a subset of ER-positive *BRCA1* mutant tumors are not sporadic, but associated with BRCA1 deficiency. In agreement, there are data suggesting that the prevalence of loss of wild-type *BRCA1* between ER+ and ER- invasive BRCA1 breast tumors do not differ (Natrajan, et al. 2012). Moreover, it seems that absence of *BRCA1* is not sufficient to breast tumors display an ER-negative phenotype (Joesse 2012).

Genomic alterations

It has been posited that the order of genetic alterations in cancer development determines the subsequent repertoire of somatic genetic alterations (Ashworth et al. 2011). Surprisingly, the whole-exome sequencing analyses of BRCA-associated breast and ovarian cancers (Network 2012; Network 2011) carried out to date have demonstrated, in a small number of tumors, that at base pair resolution the repertoire of somatic mutations these cancers harbor is diverse (**Figure 1**). The most frequently mutated gene in both BRCA1 and BRCA2 tumors

(breast and ovarian) is *TP53*. In addition, analysis of the copy number alterations (CNAs) revealed that approximately 30% of these tumors harbored recurrent amplifications of *MYC* and *TERC*. For PALB2-BCs the repertoire of somatic mutations is currently unknown.

A noteworthy genetic alteration observed in BRCA-associated tumors is the high frequency of somatic mutations affecting the *TP53* gene (Crook, et al. 1997; Network 2012; Network 2011). The p53 protein, encoded by *TP53*, is a potent transcription factor involved in many tumor suppressor mechanisms, such as cell cycle arrest, DNA repair, senescence and apoptosis (Vousden and Prives 2009). *TP53* somatic mutation determined by sequencing has been reported in over than 60% of the BRCA1-BCs but in lower frequency in BRCA2 breast tumors (Crook, et al. 1998; Manié, et al. 2009; Network 2012). Interestingly, a significant proportion of *TP53* somatic mutations are protein-truncating (nonsense and frameshift mutations), suggesting strong selection for p53 loss-of-function rather than hotspot mutations (missense) (Holstege, et al. 2009). Moreover, a high prevalence of *TP53* mutations has also been observed in BRCA-associated ovarian cancers (Network 2011). In fact, the contribution of p53 to tumorigenesis of Brca tumors has been demonstrated in mouse models. *Brca1^{+/-}Trp53^{+/-}* and *Brca2^{+/-}Trp53^{+/-}* mice show a slight increase in mammary carcinoma incidence compared with *Trp53^{+/-}* mice (Cressman, et al. 1999; Jonkers, et al. 2001). As shown recently, in BCs *TP53* mutations seem to be the second most common first event (considering PTEN loss and *BRCA1* wild-type LOH) (Martins et al. 2012). In ovarian cancer, *TP53* mutation seems to be a prerequisite to *BRCA1*-associated carcinogenesis, occurring before loss of the wild-type allele (Norquist, et al. 2010).

In addition to *TP53*, *PTEN* (phosphatase and tensin homolog) has also been shown to contribute to carcinogenesis of BRCA1-associated BC (Martins et al. 2012). The protein product of *PTEN* gene is a potent inhibitor of the phosphatidylinositol 3-Kinase (PI3K) pathway, an oncogenic signaling cascade that promotes many of the cancer hallmarks (Carracedo and Pandolfi 2008). Findings of *in vivo* studies have shown that mice carrying heterozygous inactivation of *Pten* develop basal-like mammary tumors (Saal, et al. 2008). Additionally, in breast tumors arising in *BRCA1* mutations carriers PTEN loss has

been detected in more than 80% of the cases (Phuah, et al. 2012; Saal et al. 2008). The inactivation of PTEN seems to contribute to high rate of gene rearrangements involving DNA DSBs, intragenic inversions, insertions and homozygous deletions found in BRCA1 tumors (Saal et al. 2008). Moreover, in BRCA1 breast tumors, loss of PTEN has been shown to precede *BRCA1* LOH and *TP53* mutation (Martins et al. 2012). Interestingly, PTEN deficiency may also result in increased chromosomal instability due to its role in controlling the expression of RAD51 and the cell cycle checkpoint (Gupta, et al. 2009; Shen, et al. 2007).

As mentioned previously, a common genetic alteration of BRCA1 and BRCA2 tumors include LOH. Although different studies have shown that most of BRCA tumors share this feature, findings demonstrating that *BRCA* wild-type allele may be preserved in a subset of cancer cells and that some BRCA tumors may not display loss of *BRCA* wild-type allele at all, have raised issues regarding the true impact of the *BRCA1/2* LOH on tumorigenesis (Martins et al. 2012; Osorio et al. 2002; Stefansson et al. 2011; Tung et al. 2010). Several studies have found that in a substantial proportion of the cases loss of the *BRCA1/2* wild-type allele is not an initial event (Martins et al. 2012; Stefansson et al. 2011). The findings obtained by Stefansson et al., support the hypothesis that loss of the *BRCA2* wild-type allele is a late, rather than early, event in progression of the disease (Stefansson et al. 2011). King et al have suggested that LOH is not required for the tumorigenesis of BRCA breast tumors, since a high level of heterogeneity to this molecular event within and between pre-invasive lesions and invasive cancers was found (King et al. 2007). Contrasting to breast tumors, ovarian carcinomas arising in *BRCA1* and *BRCA2* mutation carriers exhibited complete LOH (King et al. 2007). For PALB2-related BCs, the few reports of have found controversial results regarding LOH of *PALB2* (Hartley et al. 2014; Tischkowitz et al. 2007).

With regard to copy number changes (CNCs), BRCA1 and BRCA2 breast tumors show different patterns of gains and losses compared to sporadic tumors (Jönsson, et al. 2005) and despite overlaps between BRCA1 and BRCA2 tumors, many differences have been observed at the CNC level. The most frequent CNCs found in BRCA1-BCs are gains of 3q, 7p, 8q 10p, 12p, 16p and 17q and loss of

2q, 3p, 4p, 4q, 5q, 12q, 16p and 18q. In *BRCA2*-related BCs, gains of 8q, 17q22-q24 and 20q13 and loss of 8p, 6q, 11q and 13q are common (van der Groep, et al. 2011). For *PALB2* breast tumors, 1q gain, 20q gain, and 18q loss were consistently observed across tumors (Tischkowitz et al. 2007). In *BRCA*-related epithelial ovarian carcinomas the few number of studies have yielded contradictory results. Despite some data indicate that somatic alterations do not differ substantially from the ones occurring in sporadic carcinomas (Kamieniak, et al. 2013), several reports have shown that *BRCA1/2* ovarian cancers exhibit a significantly higher number of chromosomal aberrations and genomic imbalances than sporadic tumors (Israeli, et al. 2003; Walsh, et al. 2008).

New therapeutic approaches

Targeting Homologous recombination deficiency

Many of the therapies newly developed for patients with *BRCA1* and *BRCA2*-mutated BCs explore the fact that these tumors lack of DSB DNA repair by HR (Evers, et al. 2010). The most promising therapies within this category are the inhibitors of poly (ADP-ribose) polymerase (PARP) (Dedes, et al. 2011). The discovery of the synthetic lethality interactions between PARP inhibitors and HR repair deficiency provided the basis for the ongoing clinical trials. Although substantial efforts have been made, none specific treatment has been approved for patients with *BRCA*-mutated BCs and, therefore, the current repertoire of systematic therapies for this subset of patients does not differ from that with sporadic disease of the same immunohistochemical status for ER, PR and HER2 (Maxwell and Domchek 2012).

The PARPs are a large family of enzymes, which in addition to other functions participate in single-strand breaks (SSBs) repair via the base-excision repair (BER) pathway (Ashworth 2008). Despite it is important role in the cellular DNA damage response, *Parp1*^{-/-} mice are viable, fertile and do not develop early onset tumors (Conde, et al. 2001; Wang, et al. 1995). However, the inability of *Parp1*^{-/-} cells repairing SSBs via PARP activity lead to stalling and collapse of replication forks in proliferation cells, transforming SSBs in DSBs, which are potentially repaired by HR (Peng and Lin 2011).

In 2005, two simultaneously publications demonstrated the impact of PARP inhibition in BRCA1 and BRCA2-deficient cells. The results of both studies showed that the complete dysfunction of BRCA proteins linked to PARP1 inhibition lead to chromosomal instability, cell cycle arrest and apoptosis (Bryant, et al. 2005; Farmer, et al. 2005). These findings illustrate the concept of ‘synthetic lethality’, a phenomenon that occurs when the combination of two different mutations or cellular pathways inhibition lead to cell death, whereas one of the two events alone does not (Kaelin 2005).

After *in vitro* and *in vivo* studies proved the synthetic lethality between PARP1 inhibition and *BRCA1/2* dysfunction, an obvious next step was the validation of this paradigm in a clinical setting. Since then, several clinical trials have been launched to test the activity of different PARP inhibitors in the patient’s population carrying *BRCA1/2* germline mutations. Due the small and well-defined target cohort who might derive therapeutic benefit from PARP inhibitors, clinical trials of such agents are being launched in the adjuvant setting even without clear evidence supporting the efficacy in metastatic disease treatment (Sonnenblick, et al. 2015). Several PARP inhibitors, including olaparib, niraparib, rucaparib and BMN-673 are in different clinical phases of testing and have shown promising therapeutic activity as monotherapy (De Bono, et al. 2013; Drew, et al. 2011; (Fong, et al. 2009).

The first-in-human phase I study of olaparib (also known as AZD2281) observed antitumor activity in breast and ovarian tumors arising in *BRCA1/2* carriers, but not in patients without such mutations, as well as absence of toxic effect commonly associated with conventional chemotherapy (Fong et al. 2009). Subsequently, a phase II proof-of-concept trial provided evidences for the efficacy and tolerability of olaparib therapy in women carrying *BRCA1/2* mutation and advanced-stage breast cancer (Tutt, et al. 2010). Similar results were obtained in an independent study including women with confirmed *BRCA1* or *BRCA2* germline mutations and ovarian cancer (Audeh, et al. 2010). More recently, a multicenter open-label phase II study with different tumor type of advanced-stage arising in 298 *BRCA1/2* mutations carries refractory to standard therapy showed clinical benefit of olaparib in prostate and pancreatic cancer and confirmed activity in

ovarian and breast cancer. The tumor response rate observed were 31.1% (60 of 193; 95% CI, 24.6 to 38.1), 12.9% (eight of 62; 95% CI, 5.7 to 23.9), 21.7% (five of 23; 95% CI, 7.5 to 43.7), and 50.0% (four of eight; 95% CI, 15.7 to 84.3) in ovarian, breast, pancreatic, and prostate cancers, respectively (Kaufman, et al. 2015).

Initially found to induce synthetic lethality in preclinical model of loss of BRCA function (Jones, et al. 2009a), the first phase I study of Niraparib (MK-4827) was associated to an overall response rate (ORR) of 50% in a small cohort of *BRCA1/2* mutated patients with BCs (Sandhu, et al. 2013). BMN 673 in another compound belonging to the PARP inhibitors class that has showed encouraging clinical results. Firstly tested *in vitro*, BMN 673 selectively targeted tumor cells with *BRCA1*, *BRCA2*, or *PTEN* gene alterations with 20- to more than 200-fold greater potency than existing PARP1/2 inhibitors (such as olaparib, rucaparib, and veliparib) (Shen, et al. 2013). Early-phase clinical trial testing this novel and potent oral PARP inhibitor enrolled 17 and 8 patients with *BRCA1* and *BRCA2* mutations, respectively, and demonstrated good tolerability and impressive anti-tumor activity. Objective response occurred in almost 65% of the ovarian cancer patients and >30% of the patients with breast tumors (De Bono, et al. 2013). Finally, in a pre-clinical study Rucaparib (AG014699) was cytotoxic to *BRCA1/2* mutated cells and associated to a reduction in growth of xenograft tumors harboring *BRCA1/2* mutations (Drew, et al. 2011). The phase II trial of AG014699 enrolling 41 patients with advanced ovarian and/or locally advanced or metastatic breast cancer (17 breast, 24 ovary; 22 *BRCA1* deficient, 19 *BRCA2* deficient) showed ORR of 5% (2/38) with 26% (10/38) of the patients achieving stable disease for ≥ 4 months (Drew, et al. 2011).

Over the past decade a new concept termed 'BRCAness' has been proposed. BRCAness was described as a phenomenon in which HR deficiency occurs in a tumor not due *BRCA1* or *BRCA2* germline mutation, but by mutations in other genes involved in HR (Lord and Ashworth 2016). Despite PALB2-deficient cells have also been shown to be sensitive to PARP inhibitors (Buisson, et al. 2010), very little is known about what might drive therapeutic response in PALB2-associated tumors.

Resistance mechanisms

Although PARP inhibitors have emerged as promising new therapeutic approaches for tumors arising in *BRCA1/2* mutation carriers, drug resistance has become an important clinical issue. The investigation of the multiple potential resistance mechanisms has led to the identification of both processing operating through the drug target and under *BRCA1*, *BRCA2* and their pathways (Lord and Ashworth 2013).

Discovered independently by two groups, the most known mechanism of acquired resistance in this context is secondary mutations. Edwards *et al.*, using CAPAN1 pancreatic cancer cell line which harbors a *BRCA2* frameshift mutation (c.6174delT) found that resistant clones to PARP inhibitors could form RAD51 nuclear foci and prevent genomic instability, both hallmarks of an efficient HR. These resistant clones displayed a secondary *BRCA2* intragenic deletion of the region containing c.6174delT mutation and restoration of the open reading frame (ORF), resulting in the expression of new *BRCA2* isoforms (Edwards, et al. 2008). Similar results were also observed in cisplatin-resistant *BRCA2*-mutated breast-cancer cell line (Sakai, et al. 2008). Thus, secondary *BRCA2* mutations seem to be commonly associated with acquired resistance in an *in vitro* setting. In ovarian cancers, secondary mutations restoring the *BRCA2* ORF were also observed in patients who become resistant to platinum salts (Edwards et al. 2008; Sakai et al. 2008). Barber et al. analyzed resistance to olaparib in a male patient with BC and a woman with breast and ovarian cancer that were enrolled on a phase II clinical trial. Both were carriers of a truncating *BRCA2* mutation and presented multiple metastatic lesions. Deep sequencing of treatment-naive and olaparib-resistant lesions from both patients indicated the emergence of secondary mutations that potentially restored de ORF of *BRCA2* gene only in the resistant lesions (Barber, et al. 2013). Taken together, these data provide evidence that, at least in a subset of patients, platinum salts and PARP inhibitors require defective HR for their antitumor activity. Although the frequency of secondary *BRCA1/2* mutations is not precisely known, this is the most well validated mechanism of resistance to PARP inhibitors in the population of patients carrying *BRCA* mutations.

Reduced activity of p53 binding protein 1 (53BP1) has also been suggested to be a potential resistance mechanism to PARP inhibitors (Lord and Ashworth 2013). Initial studies have showed that mouse embryonic fibroblasts without a full-length form of Brca1 and deleted to 53BP1 are defective in induction of senescence and cell death. Furthermore, *in vivo* results confirmed that the embryonic lethality associated with complete Brca1-deficiency may be alleviated by 53bp1 deletion (Cao, et al. 2009). On the other hand, 53bp1 depletion did not have any effect on cells with Brca2 deficiency. Bouwman et al showed that loss of 53BP1 partially restores the homologous-recombination defect of Brca1-deficient cells and reverts their hypersensitivity to DNA-damaging agents. Moreover, these findings have potential clinical implications, given that reduced 53BP1 expression was found in a subset of sporadic triple-negative and BRCA-associated breast cancers (Bouwman, et al. 2010). Further study in a mouse model of Brca1 deficiency showed that mammary gland tumors that initially were sensitive to olaparib developed resistance associated with 53bp1 factor. In a subset of the cases (3 out of 11), this resistance was caused by partial restoration of homologous recombination due to somatic loss of 53BP1 (Jaspers, et al. 2013).

Conclusion and perspectives

After two decades of efforts we have witnessed remarkable advances in our understanding of basic aspects of *BRCA1/2* and *PALB2* genes. The roles of these genes on DNA repair by HR and the discovery of synthetic lethal interaction between PARP inhibition and BRCA1 or BRCA2 deficiency allowed us to make progress in the clinical setting. Despite advances have been made, many questions remain. For example, although the identification of abnormal phenotypes even in normal cells of *BRCA1/2* and *PALB2* germline mutation carriers, suggesting haploinsufficiency for specific BRCA functions, the contributions of it for cancer predisposition still remain controversial. Additionally, the molecular basis underlying the tissue-specificity genetic predisposition associated to *BRCA1/2* and *PALB2* mutations, as well as the impact of the *BRCA* or *PALB2* wild-type allele (absence of LOH) within tumors on the DNA repair by HR and response to therapies are still unknown. Finally, the understanding of the

molecular abnormalities associated to BRCA and PALB2-associated tumors will not only provide insights into the pathogenesis of these cancers, but also will help to identify novel targets for therapies as well as predictive markers for HR deficiency and drug response.

TABLES AND FIGURES

Table 1. Pathological and molecular characteristics of *BRCA1*, *BRCA2* and *PALB2*-associated breast tumors.

Table 1.

	BRCA1 breast tumors	BRCA2 breast tumors	PALB2 tumors	References
Immunophenotype				
ER-positive	22%	77%	53%	Mavaddat, et al. 2012 Heikkinen, et al. 2009
PR-positive	21%	64%	43%	Mavaddat, et al. 2012 Heikkinen, et al. 2009
HER2-positive	10%	13%	4%	Mavaddat, et al. 2012 Heikkinen, et al. 2009
Cyclin D1	Usually negative	Usually positive	Usually negative/Low	Palacios, et al. 2005, Heikkinen, et al. 2009 Armes, et al. 1999
Cyclins E, A and B1	Usually positive	Usually negative	-	Palacios, et al. 2005
p16, p27 and p21	Usually negative	Usually positive	-	Palacios, et al. 2005
PTEN loss	>80%	-	-	Phuah, et al. 2012 Saal, et al. 2008
Basal markers	Usually positive	Usually negative	Usually negative	Honrado, et al. 2006, Heikkinen, et al. 2009 Armes, et al. 1999
Ki-67	Higher expression ^a	Similar ^a	Higher expression ^a	Heikkinen, et al. 2009
Genetic alterations				
<i>TP53</i> somatic mutation ^b	67-95%	66.6%	-	Manié, et al. 2009; Crook, et al. 1998
<i>BRCA</i> or <i>PALB2</i> LOH	84-100%	55-83%	0-33%	Martins, et al. 2012; Tung, et al. 2010; Osorio, et al. 2002; Hartley, 2014; Tischkowitz, et al. 2007
<i>MYC</i> amplification	18.-53%	62.%		Network 2012; Palacios et al., 2003
<i>CCND1</i> amplification	0-22%	13-60%		Vaziri et al., 2005; Plevova et al., 2010; Brown et al., 2010;

^acompared to sporadic tumors

^bmutation analysis from exon 2 to 11

References

- BRCA1 and BRCA2: different roles in a common pathway of genome protection.* 1997 Pathology of familial breast cancer: differences between breast cancers in carriers of BRCA1 or BRCA2 mutations and sporadic cases. Breast Cancer Linkage Consortium. *Lancet* 349 1505-1510.
- Agnarsson BA, Jonasson JG, Björnsdóttir IB, Barkardóttir RB, Egilsson V & Sigurdsson H 1998 Inherited BRCA2 mutation associated with high grade breast cancer. *Breast Cancer Res Treat* 47 121-127.
- Al-Mulla F, Bland JM, Serratt D, Miller J, Chu C & Taylor GT 2009 Age-dependent penetrance of different germline mutations in the BRCA1 gene. *J Clin Pathol* 62 350-356.
- Aleskandarany M, Caracappa D, Nolan CC, Macmillan RD, Ellis IO, Rakha EA & Green AR 2015 DNA damage response markers are differentially expressed in BRCA-mutated breast cancers. *Breast Cancer Res Treat* 150 81-90.
- Alter BP, Rosenberg PS & Brody LC 2007 Clinical and molecular features associated with biallelic mutations in FANCD1/BRCA2. *J Med Genet* 44 1-9.
- Anderson DE & Badzioch MD 1992 Breast cancer risks in relatives of male breast cancer patients. *J Natl Cancer Inst* 84 1114-1117.
- Antoniou A, Pharoah PD, Narod S, Risch HA, Eyfjord JE, Hopper JL, Loman N, Olsson H, Johannsson O, Borg A, et al. 2003 Average risks of breast and ovarian cancer associated with BRCA1 or BRCA2 mutations detected in case Series unselected for family history: a combined analysis of 22 studies. *Am J Hum Genet* 72 1117-1130.
- Antoniou AC, Casadei S, Heikkinen T, Barrowdale D, Pylkäs K, Roberts J, Lee A, Subramanian D, De Leeneer K, Fostira F, et al. 2014 Breast-cancer risk in families with mutations in PALB2. *N Engl J Med* 371 497-506.
- Armes JE, Trute L, White D, Southey MC, Hammet F, Tesoriero A, Hutchins AM, Dite GS, McCredie MR, Giles GG, et al. 1999 Distinct molecular pathogeneses of early-onset breast cancers in BRCA1 and BRCA2 mutation carriers: a population-based study. *Cancer Res* 59 2011-2017.
- Arnold K, Kim MK, Frerk K, Edler L, Savelyeva L, Schmezer P & Wiedemeyer R 2006 Lower level of BRCA2 protein in heterozygous mutation carriers is correlated with an increase in DNA double strand breaks and an impaired DSB repair. *Cancer Lett* 243 90-100.
- Arun B, Vogel KJ, Lopez A, Hernandez M, Atchley D, Broglio KR, Amos CI, Meric-Bernstam F, Kuerer H, Hortobagyi GN, et al. 2009 High prevalence of preinvasive lesions adjacent to BRCA1/2-associated breast cancers. *Cancer Prev Res (Phila)*

2 122-127.

Ashworth A 2008 A synthetic lethal therapeutic approach: poly(ADP) ribose polymerase inhibitors for the treatment of cancers deficient in DNA double-strand break repair. *J Clin Oncol* 26 3785-3790.

Ashworth A, Lord CJ & Reis-Filho JS 2011 Genetic interactions in cancer progression and treatment. *Cell* 145 30-38.

Audeh MW, Carmichael J, Penson RT, Friedlander M, Powell B, Bell-McGuinn KM, Scott C, Weitzel JN, Oaknin A, Loman N, et al. 2010 Oral poly(ADP-ribose) polymerase inhibitor olaparib in patients with BRCA1 or BRCA2 mutations and recurrent ovarian cancer: a proof-of-concept trial. *Lancet* 376 245-251.

Badie S, Escandell JM, Bouwman P, Carlos AR, Thanasoula M, Gallardo MM, Suram A, Jaco I, Benitez J, Herbig U, et al. 2010 BRCA2 acts as a RAD51 loader to facilitate telomere replication and capping. *Nat Struct Mol Biol* 17 1461-1469.

Badve S, Dabbs DJ, Schnitt SJ, Baehner FL, Decker T, Eusebi V, Fox SB, Ichihara S, Jacquemier J, Lakhani SR, et al. 2011 Basal-like and triple-negative breast cancers: a critical review with an emphasis on the implications for pathologists and oncologists. *Mod Pathol* 24 157-167.

Baldeyron C, Jacquemin E, Smith J, Jacquemont C, De Oliveira I, Gad S, Feunteun J, Stoppa-Lyonnet D & Papadopoulo D 2002 A single mutated BRCA1 allele leads to impaired fidelity of double strand break end-joining. *Oncogene* 21 1401-1410.

Bane AL, Beck JC, Bleiweiss I, Buys SS, Catalano E, Daly MB, Giles G, Godwin AK, Hibshoosh H, Hopper JL, et al. 2007 BRCA2 mutation-associated breast cancers exhibit a distinguishing phenotype based on morphology and molecular profiles from tissue microarrays. *Am J Surg Pathol* 31 121-128.

Barber LJ, Sandhu S, Chen L, Campbell J, Kozarewa I, Fenwick K, Assiotis I, Rodrigues DN, Reis Filho JS, Moreno V, et al. 2013 Secondary mutations in BRCA2 associated with clinical resistance to a PARP inhibitor. *J Pathol* 229 422-429.

Basham VM, Lipscombe JM, Ward JM, Gayther SA, Ponder BA, Easton DF & Pharoah PD 2002 BRCA1 and BRCA2 mutations in a population-based study of male breast cancer. *Breast Cancer Res* 4 R2.

Bellacosa A, Godwin AK, Peri S, Devarajan K, Caretti E, Vanderveer L, Bove B, Slater C, Zhou Y, Daly M, et al. 2010 Altered gene expression in morphologically normal epithelial cells from heterozygous carriers of BRCA1 or BRCA2 mutations. *Cancer Prev Res (Phila)* 3 48-61.

Berger AH, Knudson AG & Pandolfi PP 2011 A continuum model for tumour

suppression. *Nature* 476 163-169.

Borg A, Haile RW, Malone KE, Capanu M, Diep A, Törngren T, Teraoka S, Begg CB, Thomas DC, Concannon P, et al. 2010 Characterization of BRCA1 and BRCA2 deleterious mutations and variants of unknown clinical significance in unilateral and bilateral breast cancer: the WECARE study. *Hum Mutat* 31 E1200-1240.

Bouwman P, Aly A, Escandell JM, Pieterse M, Bartkova J, van der Gulden H, Hiddingh S, Thanasoula M, Kulkarni A, Yang Q, et al. 2010 53BP1 loss rescues BRCA1 deficiency and is associated with triple-negative and BRCA-mutated breast cancers. *Nat Struct Mol Biol* 17 688-695.

Bowman-Colin C, Xia B, Bunting S, Klijn C, Drost R, Bouwman P, Fineman L, Chen X, Culhane AC, Cai H, et al. 2013 Palb2 synergizes with Trp53 to suppress mammary tumor formation in a model of inherited breast cancer. *Proc Natl Acad Sci U S A* 110 8632-8637.

Brandsma I & Gent DC 2012 Pathway choice in DNA double strand break repair: observations of a balancing act. *Genome Integr* 3 9.

Brose MS, Rebbeck TR, Calzone KA, Stopfer JE, Nathanson KL & Weber BL 2002 Cancer risk estimates for BRCA1 mutation carriers identified in a risk evaluation program. *J Natl Cancer Inst* 94 1365-1372.

Bryant HE, Schultz N, Thomas HD, Parker KM, Flower D, Lopez E, Kyle S, Meuth M, Curtin NJ & Helleday T 2005 Specific killing of BRCA2-deficient tumours with inhibitors of poly(ADP-ribose) polymerase. *Nature* 434 913-917.

Buchholz TA, Wu X, Hussain A, Tucker SL, Mills GB, Haffty B, Bergh S, Story M, Geara FB & Brock WA 2002 Evidence of haplotype insufficiency in human cells containing a germline mutation in BRCA1 or BRCA2. *Int J Cancer* 97 557-561.

Buisson R, Dion-Côté AM, Coulombe Y, Launay H, Cai H, Stasiak AZ, Stasiak A, Xia B & Masson JY 2010 Cooperation of breast cancer proteins PALB2 and piccolo BRCA2 in stimulating homologous recombination. *Nat Struct Mol Biol* 17 1247-1254.

Burga LN, Tung NM, Troyan SL, Bostina M, Konstantinopoulos PA, Fountzilias H, Spentzos D, Miron A, Yassin YA, Lee BT, et al. 2009 Altered proliferation and differentiation properties of primary mammary epithelial cells from BRCA1 mutation carriers. *Cancer Res* 69 1273-1278.

Burma S, Chen BP & Chen DJ 2006 Role of non-homologous end joining (NHEJ) in maintaining genomic integrity. *DNA Repair (Amst)* 5 1042-1048.

Cao L, Xu X, Bunting SF, Liu J, Wang RH, Cao LL, Wu JJ, Peng TN, Chen J, Nussenzweig A, et al. 2009 A selective requirement for 53BP1 in the biological

response to genomic instability induced by Brca1 deficiency. *Mol Cell* 35 534-541.

Carracedo A & Pandolfi PP 2008 The PTEN-PI3K pathway: of feedbacks and cross-talks. *Oncogene* 27 5527-5541.

Casadei S, Norquist BM, Walsh T, Stray S, Mandell JB, Lee MK, Stamatoyannopoulos JA & King MC 2011 Contribution of inherited mutations in the BRCA2-interacting protein PALB2 to familial breast cancer. *Cancer Res* 71 2222-2229.

Chappuis PO, Donato E, Goffin JR, Wong N, Bégin LR, Kapusta LR, Brunet JS, Porter P & Foulkes WD 2005 Cyclin E expression in breast cancer: predicting germline BRCA1 mutations, prognosis and response to treatment. *Ann Oncol* 16 735-742.

Cheon JY, Mozersky J & Cook-Deegan R 2014 Variants of uncertain significance in BRCA: a harbinger of ethical and policy issues to come? *Genome Med* 6 121.

Choi E, Park PG, Lee HO, Lee YK, Kang GH, Lee JW, Han W, Lee HC, Noh DY, Lekontsev S, et al. 2012 BRCA2 fine-tunes the spindle assembly checkpoint through reinforcement of BubR1 acetylation. *Dev Cell* 22 295-308.

Conde C, Mark M, Oliver FJ, Huber A, de Murcia G & Ménissier-de Murcia J 2001 Loss of poly(ADP-ribose) polymerase-1 causes increased tumour latency in p53-deficient mice. *EMBO J* 20 3535-3543.

Connor F, Smith A, Wooster R, Stratton M, Dixon A, Campbell E, Tait TM, Freeman T & Ashworth A 1997 Cloning, chromosomal mapping and expression pattern of the mouse Brca2 gene. *Hum Mol Genet* 6 291-300.

Consortium BCL 1999 Cancer risks in BRCA2 mutation carriers. *J Natl Cancer Inst* 91 1310-1316.

Cressman VL, Backlund DC, Hicks EM, Gowen LC, Godfrey V & Koller BH 1999 Mammary tumor formation in p53- and BRCA1-deficient mice. *Cell Growth Differ* 10 1-10.

Crook T, Brooks LA, Crossland S, Osin P, Barker KT, Waller J, Philp E, Smith PD, Yulug I, Peto J, et al. 1998 p53 mutation with frequent novel condons but not a mutator phenotype in BRCA1- and BRCA2-associated breast tumours. *Oncogene* 17 1681-1689.

Crook T, Crossland S, Crompton MR, Osin P & Gusterson BA 1997 p53 mutations in BRCA1-associated familial breast cancer. *Lancet* 350 638-639.

Csokay B, Udvarhelyi N, Sulyok Z, Besznyak I, Ramus S, Ponder B & Olah E 1999 High frequency of germ-line BRCA2 mutations among Hungarian male breast cancer patients without family history. *Cancer Res* 59 995-998.

Cybulski C, Kluźniak W, Huzarski T, Wokołorczyk D, Kashyap A, Jakubowska A, Szwiec M, Byrski T, Dębniak T, Górski B, et al. 2015 Clinical outcomes in women with breast cancer and a PALB2 mutation: a prospective cohort analysis. *Lancet Oncol* 16 638-644.

Dedes KJ, Wilkerson PM, Wetterskog D, Weigelt B, Ashworth A & Reis-Filho JS 2011 Synthetic lethality of PARP inhibition in cancers lacking BRCA1 and BRCA2 mutations. *Cell Cycle* 10 1192-1199.

Ding YC, Steele L, Kuan CJ, Greilac S & Neuhausen SL 2011 Mutations in BRCA2 and PALB2 in male breast cancer cases from the United States. *Breast Cancer Res Treat* 126 771-778.

Drost RM & Jonkers J 2009 Preclinical mouse models for BRCA1-associated breast cancer. *Br J Cancer* 101 1651-1657.

Edwards SL, Brough R, Lord CJ, Natrajan R, Vatcheva R, Levine DA, Boyd J, Reis-Filho JS & Ashworth A 2008 Resistance to therapy caused by intragenic deletion in BRCA2. *Nature* 451 1111-1115.

Erkko H, Dowty JG, Nikkilä J, Syrjäkoski K, Mannermaa A, Pylkäs K, Southey MC, Holli K, Kallioniemi A, Jukkola-Vuorinen A, et al. 2008 Penetrance analysis of the PALB2 c.1592delT founder mutation. *Clin Cancer Res* 14 4667-4671.

Erkko H, Xia B, Nikkilä J, Schleutker J, Syrjäkoski K, Mannermaa A, Kallioniemi A, Pylkäs K, Karppinen SM, Rapakko K, et al. 2007 A recurrent mutation in PALB2 in Finnish cancer families. *Nature* 446 316-319.

Evers B, Helleday T & Jonkers J 2010 Targeting homologous recombination repair defects in cancer. *Trends Pharmacol Sci* 31 372-380.

Ewald IP, Ribeiro PL, Palmero EI, Cossio SL, Giugliani R & Ashton-Prolla P 2009 Genomic rearrangements in BRCA1 and BRCA2: A literature review. *Genet Mol Biol* 32 437-446.

Farmer H, McCabe N, Lord CJ, Tutt AN, Johnson DA, Richardson TB, Santarosa M, Dillon KJ, Hickson I, Knights C, et al. 2005 Targeting the DNA repair defect in BRCA mutant cells as a therapeutic strategy. *Nature* 434 917-921.

Feilotter HE, Michel C, Uy P, Bathurst L & Davey S 2014 BRCA1 haploinsufficiency leads to altered expression of genes involved in cellular proliferation and development. *PLoS One* 9 e100068.

Ferrone CR, Levine DA, Tang LH, Allen PJ, Jarnagin W, Brennan MF, Offit K & Robson ME 2009 BRCA germline mutations in Jewish patients with pancreatic adenocarcinoma. *J Clin Oncol* 27 433-438.

Finch A, Beiner M, Lubinski J, Lynch HT, Moller P, Rosen B, Murphy J, Ghadirian P, Friedman E, Foulkes WD, et al. 2006 Salpingo-oophorectomy and the risk of ovarian, fallopian tube, and peritoneal cancers in women with a BRCA1 or BRCA2 Mutation. *JAMA* 296 185-192.

Fong PC, Boss DS, Yap TA, Tutt A, Wu P, Mergui-Roelvink M, Mortimer P, Swaisland H, Lau A, O'Connor MJ, et al. 2009 Inhibition of poly(ADP-ribose) polymerase in tumors from BRCA mutation carriers. *N Engl J Med* 361 123-134.

Foulkes WD, Stefansson IM, Chappuis PO, Bégin LR, Goffin JR, Wong N, Trudel M & Akslen LA 2003 Germline BRCA1 mutations and a basal epithelial phenotype in breast cancer. *J Natl Cancer Inst* 95 1482-1485.

Frank TS, Deffenbaugh AM, Reid JE, Hulick M, Ward BE, Lingenfelter B, Gumpfer KL, Scholl T, Tavtigian SV, Pruss DR, et al. 2002 Clinical characteristics of individuals with germline mutations in BRCA1 and BRCA2: analysis of 10,000 individuals. *J Clin Oncol* 20 1480-1490.

French JD, Dunn J, Smart CE, Manning N & Brown MA 2006 Disruption of BRCA1 function results in telomere lengthening and increased anaphase bridge formation in immortalized cell lines. *Genes Chromosomes Cancer* 45 277-289.

Gabai-Kapara E, Lahad A, Kaufman B, Friedman E, Segev S, Renbaum P, Beeri R, Gal M, Grinshpun-Cohen J, Djemal K, et al. 2014 Population-based screening for breast and ovarian cancer risk due to BRCA1 and BRCA2. *Proc Natl Acad Sci U S A* 111 14205-14210.

García MJ, Fernández V, Osorio A, Barroso A, Llorca G, Lázaro C, Blanco I, Caldés T, de la Hoya M, Ramón Y Cajal T, et al. 2009 Analysis of FANCB and FANCN/PALB2 fanconi anemia genes in BRCA1/2-negative Spanish breast cancer families. *Breast Cancer Res Treat* 113 545-551.

Gorski JJ, Kennedy RD, Hosey AM & Harkin DP 2009 The complex relationship between BRCA1 and ERalpha in hereditary breast cancer. *Clin Cancer Res* 15 1514-1518.

Gowen LC, Johnson BL, Latour AM, Sulik KK & Koller BH 1996 Brca1 deficiency results in early embryonic lethality characterized by neuroepithelial abnormalities. *Nat Genet* 12 191-194.

Gudmundsdottir K & Ashworth A 2006 The roles of BRCA1 and BRCA2 and associated proteins in the maintenance of genomic stability. *Oncogene* 25 5864-5874.

Gupta A, Yang Q, Pandita RK, Hunt CR, Xiang T, Misri S, Zeng S, Pagan J, Jeffery J, Puc J, et al. 2009 Cell cycle checkpoint defects contribute to genomic instability in PTEN deficient cells independent of DNA DSB repair. *Cell Cycle* 8 2198-2210.

Haanpää M, Pylkäs K, Moilanen JS & Winqvist R 2013 Evaluation of the need for routine clinical testing of PALB2 c.1592delT mutation in BRCA negative Northern Finnish breast cancer families. *BMC Med Genet* 14 82.

Hartley T, Cavallone L, Sabbaghian N, Silva-Smith R, Hamel N, Aleynikova O, Smith E, Hastings V, Pinto P, Tischkowitz M, et al. 2014 Mutation analysis of PALB2 in BRCA1 and BRCA2-negative breast and/or ovarian cancer families from Eastern Ontario, Canada. *Hered Cancer Clin Pract* 12 19.

Heikkinen T, Kärkkäinen H, Aaltonen K, Milne RL, Heikkilä P, Aittomäki K, Blomqvist C & Nevanlinna H 2009 The breast cancer susceptibility mutation PALB2 1592delT is associated with an aggressive tumor phenotype. *Clin Cancer Res* 15 3214-3222.

Hemminki K & Vaittinen P 1999 Male breast cancer: risk to daughters. *Lancet* 353 1186-1187.

Hill SJ, Rolland T, Adelmant G, Xia X, Owen MS, Dricot A, Zack TI, Sahni N, Jacob Y, Hao T, et al. 2014 Systematic screening reveals a role for BRCA1 in the response to transcription-associated DNA damage. *Genes Dev* 28 1957-1975.

Holstege H, Joosse SA, van Oostrom CT, Nederlof PM, de Vries A & Jonkers J 2009 High incidence of protein-truncating TP53 mutations in BRCA1-related breast cancer. *Cancer Res* 69 3625-3633.

Honrado E, Benítez J & Palacios J 2005 The molecular pathology of hereditary breast cancer: genetic testing and therapeutic implications. *Mod Pathol* 18 1305-1320.

Honrado E, Osorio A, Palacios J & Benitez J 2006 Pathology and gene expression of hereditary breast tumors associated with BRCA1, BRCA2 and CHEK2 gene mutations. *Oncogene* 25 5837-5845.

Hoogerbrugge N, Bult P, Bonenkamp JJ, Ligtenberg MJ, Kiemeny LA, de Hullu JA, Boetes C, Niermeijer MF & Brunner HG 2006 Numerous high-risk epithelial lesions in familial breast cancer. *Eur J Cancer* 42 2492-2498.

Hoogerbrugge N, Bult P, de Widt-Levert LM, Beex LV, Kiemeny LA, Ligtenberg MJ, Massuger LF, Boetes C, Manders P & Brunner HG 2003 High prevalence of premalignant lesions in prophylactically removed breasts from women at hereditary risk for breast cancer. *J Clin Oncol* 21 41-45.

Hosey AM, Gorski JJ, Murray MM, Quinn JE, Chung WY, Stewart GE, James CR, Farragher SM, Mulligan JM, Scott AN, et al. 2007 Molecular basis for estrogen receptor alpha deficiency in BRCA1-linked breast cancer. *J Natl Cancer Inst* 99 1683-1694.

Howlett NG, Taniguchi T, Olson S, Cox B, Waisfisz Q, De Die-Smulders C, Persky N, Grompe M, Joenje H, Pals G, et al. 2002 Biallelic inactivation of BRCA2 in Fanconi anemia. *Science* 297 606-609.

Isern AE, Loman N, Malina J, Olsson H & Ringberg A 2008 Histopathological findings and follow-up after prophylactic mastectomy and immediate breast reconstruction in 100 women from families with hereditary breast cancer. *Eur J Surg Oncol* 34 1148-1154.

Israeli O, Gotlieb WH, Friedman E, Goldman B, Ben-Baruch G, Aviram-Goldring A & Rienstein S 2003 Familial vs sporadic ovarian tumors: characteristic genomic alterations analyzed by CGH. *Gynecol Oncol* 90 629-636.

Jaspers JE, Kersbergen A, Boon U, Sol W, van Deemter L, Zander SA, Drost R, Wientjens E, Ji J, Aly A, et al. 2013 Loss of 53BP1 causes PARP inhibitor resistance in Brca1-mutated mouse mammary tumors. *Cancer Discov* 3 68-81.

Jones P, Altamura S, Boueres J, Ferrigno F, Fonsi M, Giomini C, Lamartina S, Monteagudo E, Ontoria JM, Orsale MV, et al. 2009a Discovery of 2-{4-[(3S)-piperidin-3-yl]phenyl}-2H-indazole-7-carboxamide (MK-4827): a novel oral poly(ADP-ribose)polymerase (PARP) inhibitor efficacious in BRCA-1 and -2 mutant tumors. *J Med Chem* 52 7170-7185.

Jones S, Hruban RH, Kamiyama M, Borges M, Zhang X, Parsons DW, Lin JC, Palmisano E, Brune K, Jaffee EM, et al. 2009b Exomic sequencing identifies PALB2 as a pancreatic cancer susceptibility gene. *Science* 324 217.

Jonkers J, Meuwissen R, van der Gulden H, Peterse H, van der Valk M & Berns A 2001 Synergistic tumor suppressor activity of BRCA2 and p53 in a conditional mouse model for breast cancer. *Nat Genet* 29 418-425.

Josse SA 2012 BRCA1 and BRCA2: a common pathway of genome protection but different breast cancer subtypes. *Nat Rev Cancer* 12 372; author reply 372.

Joukov V, Groen AC, Prokhorova T, Gerson R, White E, Rodriguez A, Walter JC & Livingston DM 2006 The BRCA1/BARD1 heterodimer modulates ran-dependent mitotic spindle assembly. *Cell* 127 539-552.

Jönsson G, Naylor TL, Vallon-Christersson J, Staaf J, Huang J, Ward MR, Greshock JD, Luts L, Olsson H, Rahman N, et al. 2005 Distinct genomic profiles in hereditary breast tumors identified by array-based comparative genomic hybridization. *Cancer Res* 65 7612-7621.

Kaelin WG 2005 The concept of synthetic lethality in the context of anticancer therapy. *Nat Rev Cancer* 5 689-698.

Kamieniak MM, Muñoz-Repeto I, Rico D, Osorio A, Urioste M, García-Donas J, Hernando S, Robles-Díaz L, Ramón Y Cajal T, Cazorla A, et al. 2013 DNA copy

number profiling reveals extensive genomic loss in hereditary BRCA1 and BRCA2 ovarian carcinomas. *Br J Cancer* 108 1732-1742.

Kauff ND, Brogi E, Scheuer L, Pathak DR, Borgen PI, Hudis CA, Offit K & Robson ME 2003 Epithelial lesions in prophylactic mastectomy specimens from women with BRCA mutations. *Cancer* 97 1601-1608.

Kaufman B, Shapira-Frommer R, Schmutzler RK, Audeh MW, Friedlander M, Balmaña J, Mitchell G, Fried G, Stemmer SM, Hubert A, et al. 2015 Olaparib monotherapy in patients with advanced cancer and a germline BRCA1/2 mutation. *J Clin Oncol* 33 244-250.

Kim MK, Zitzmann S, Westermann F, Arnold K, Brouwers S, Schwab M & Savelyeva L 2004 Increased rates of spontaneous sister chromatid exchange in lymphocytes of BRCA2+/- carriers of familial breast cancer clusters. *Cancer Lett* 210 85-94.

King TA, Li W, Brogi E, Yee CJ, Gemignani ML, Olvera N, Levine DA, Norton L, Robson ME, Offit K, et al. 2007 Heterogenic loss of the wild-type BRCA allele in human breast tumorigenesis. *Ann Surg Oncol* 14 2510-2518.

Knudson AG 1971 Mutation and cancer: statistical study of retinoblastoma. *Proc Natl Acad Sci U S A* 68 820-823.

Konishi H, Mohseni M, Tamaki A, Garay JP, Croessmann S, Karnan S, Ota A, Wong HY, Konishi Y, Karakas B, et al. 2011 Mutation of a single allele of the cancer susceptibility gene BRCA1 leads to genomic instability in human breast epithelial cells. *Proc Natl Acad Sci U S A* 108 17773-17778.

Lakhani SR, Jacquemier J, Sloane JP, Gusterson BA, Anderson TJ, van de Vijver MJ, Farid LM, Venter D, Antoniou A, Storer-Isser A, et al. 1998 Multifactorial analysis of differences between sporadic breast cancers and cancers involving BRCA1 and BRCA2 mutations. *J Natl Cancer Inst* 90 1138-1145.

Lakhani SR, Reis-Filho JS, Fulford L, Penault-Llorca F, van der Vijver M, Parry S, Bishop T, Benitez J, Rivas C, Bignon YJ, et al. 2005 Prediction of BRCA1 status in patients with breast cancer using estrogen receptor and basal phenotype. *Clin Cancer Res* 11 5175-5180.

Levy-Lahad E & Friedman E 2007 Cancer risks among BRCA1 and BRCA2 mutation carriers. *Br J Cancer* 96 11-15.

Lieber MR 2010 The mechanism of double-strand DNA break repair by the nonhomologous DNA end-joining pathway. *Annu Rev Biochem* 79 181-211.

Lim E, Vaillant F, Wu D, Forrest NC, Pal B, Hart AH, Asselin-Labat ML, Gyorki DE, Ward T, Partanen A, et al. 2009 Aberrant luminal progenitors as the candidate target population for basal tumor development in BRCA1 mutation carriers. *Nat*

Med 15 907-913.

Liu G, Yang D, Sun Y, Shmulevich I, Xue F, Sood AK & Zhang W 2012 Differing clinical impact of BRCA1 and BRCA2 mutations in serous ovarian cancer. *Pharmacogenomics* 13 1523-1535.

Lord CJ & Ashworth A 2013 Mechanisms of resistance to therapies targeting BRCA-mutant cancers. *Nat Med* 19 1381-1388.

Lord CJ & Ashworth A 2016 BRCAness revisited. *Nat Rev Cancer*.

Lynch BJ, Holden JA, Buys SS, Neuhausen SL & Gaffney DK 1998 Pathobiologic characteristics of hereditary breast cancer. *Hum Pathol* 29 1140-1144.

Manié E, Vincent-Salomon A, Lehmann-Che J, Pierron G, Turpin E, Warcoin M, Gruel N, Lebigot I, Sastre-Garau X, Lidereau R, et al. 2009 High frequency of TP53 mutation in BRCA1 and sporadic basal-like carcinomas but not in BRCA1 luminal breast tumors. *Cancer Res* 69 663-671.

Mao Z, Bozzella M, Seluanov A & Gorbunova V 2008 DNA repair by nonhomologous end joining and homologous recombination during cell cycle in human cells. *Cell Cycle* 7 2902-2906.

Martins FC, De S, Almendro V, Gönen M, Park SY, Blum JL, Herlihy W, Ethington G, Schnitt SJ, Tung N, et al. 2012 Evolutionary pathways in BRCA1-associated breast tumors. *Cancer Discov* 2 503-511.

Mathew CG 2006 Fanconi anaemia genes and susceptibility to cancer. *Oncogene* 25 5875-5884.

Mavaddat N, Barrowdale D, Andrulis IL, Domchek SM, Eccles D, Nevanlinna H, Ramus SJ, Spurdle A, Robson M, Sherman M, et al. 2012 Pathology of breast and ovarian cancers among BRCA1 and BRCA2 mutation carriers: results from the Consortium of Investigators of Modifiers of BRCA1/2 (CIMBA). *Cancer Epidemiol Biomarkers Prev* 21 134-147.

Maxwell KN & Domchek SM 2012 Cancer treatment according to BRCA1 and BRCA2 mutations. *Nat Rev Clin Oncol* 9 520-528.

Melchor L, Honrado E, García MJ, Alvarez S, Palacios J, Osorio A, Nathanson KL & Benítez J 2008 Distinct genomic aberration patterns are found in familial breast cancer associated with different immunohistochemical subtypes. *Oncogene* 27 3165-3175.

Metzger MJ, Stoddard BL & Monnat RJ 2013 PARP-mediated repair, homologous recombination, and back-up non-homologous end joining-like repair of single-strand nicks. *DNA Repair (Amst)* 12 529-534.

Meyer S, Tischkowitz M, Chandler K, Gillespie A, Birch JM & Evans DG 2014 Fanconi anaemia, BRCA2 mutations and childhood cancer: a developmental perspective from clinical and epidemiological observations with implications for genetic counselling. *J Med Genet* 51 71-75.

Miki Y, Swensen J, Shattuck-Eidens D, Futreal PA, Harshman K, Tavtigian S, Liu Q, Cochran C, Bennett LM & Ding W 1994 A strong candidate for the breast and ovarian cancer susceptibility gene BRCA1. *Science* 266 66-71.

Molyneux G, Geyer FC, Magnay FA, McCarthy A, Kendrick H, Natrajan R, Mackay A, Grigoriadis A, Tutt A, Ashworth A, et al. 2010 BRCA1 basal-like breast cancers originate from luminal epithelial progenitors and not from basal stem cells. *Cell Stem Cell* 7 403-417.

Moynahan ME 2002 The cancer connection: BRCA1 and BRCA2 tumor suppression in mice and humans. *Oncogene* 21 8994-9007.

Moynahan ME, Chiu JW, Koller BH & Jasin M 1999 Brca1 controls homology-directed DNA repair. *Mol Cell* 4 511-518.

Moynahan ME, Pierce AJ & Jasin M 2001 BRCA2 is required for homology-directed repair of chromosomal breaks. *Mol Cell* 7 263-272.

Narod SA & Foulkes WD 2004 BRCA1 and BRCA2: 1994 and beyond. *Nat Rev Cancer* 4 665-676.

Natrajan R, Mackay A, Lambros MB, Weigelt B, Wilkerson PM, Manie E, Grigoriadis A, A'hern R, van der Groep P, Kozarewa I, et al. 2012 A whole-genome massively parallel sequencing analysis of BRCA1 mutant oestrogen receptor-negative and -positive breast cancers. *J Pathol* 227 29-41.

Network CGA 2012 Comprehensive molecular portraits of human breast tumours. *Nature* 490 61-70.

Network CGAR 2011 Integrated genomic analyses of ovarian carcinoma. *Nature* 474 609-615.

Nguyen-Dumont T, Hammet F, Mahmoodi M, Tsimiklis H, Teo ZL, Li R, Pope BJ, Terry MB, Buys SS, Daly M, et al. 2015 Mutation screening of PALB2 in clinically ascertained families from the Breast Cancer Family Registry. *Breast Cancer Res Treat* 149 547-554.

Nikkilä J, Parpys AC, Pylkäs K, Bose M, Huo Y, Borgmann K, Rapakko K, Nieminen P, Xia B, Pospiech H, et al. 2013 Heterozygous mutations in PALB2 cause DNA replication and damage response defects. *Nat Commun* 4 2578.

Norquist BM, Garcia RL, Allison KH, Jokinen CH, Kernochan LE, Pizzi CC, Barrow BJ, Goff BA & Swisher EM 2010 The molecular pathogenesis of hereditary ovarian

carcinoma: alterations in the tubal epithelium of women with BRCA1 and BRCA2 mutations. *Cancer* 116 5261-5271.

Obermeier K, Sachsenweger J, Friedl TW, Pospiech H, Winqvist R & Wiesmüller L 2015 Heterozygous PALB2 c.1592delT mutation channels DNA double-strand break repair into error-prone pathways in breast cancer patients. *Oncogene*.

Osorio A, de la Hoya M, Rodríguez-López R, Martínez-Ramírez A, Cazorla A, Granizo JJ, Esteller M, Rivas C, Caldés T & Benítez J 2002 Loss of heterozygosity analysis at the BRCA loci in tumor samples from patients with familial breast cancer. *Int J Cancer* 99 305-309.

Ottini L, Rizzolo P, Zanna I, Falchetti M, Masala G, Ceccarelli K, Vezzosi V, Gulino A, Giannini G, Bianchi S, et al. 2009 BRCA1/BRCA2 mutation status and clinical-pathologic features of 108 male breast cancer cases from Tuscany: a population-based study in central Italy. *Breast Cancer Res Treat* 116 577-586.

Palacios J, Honrado E, Osorio A, Cazorla A, Sarrió D, Barroso A, Rodríguez S, Cigudosa JC, Diez O, Alonso C, et al. 2005 Phenotypic characterization of BRCA1 and BRCA2 tumors based in a tissue microarray study with 37 immunohistochemical markers. *Breast Cancer Res Treat* 90 5-14.

Palacios J, Honrado E, Osorio A, Cazorla A, Sarrió D, Barroso A, Rodríguez S, Cigudosa JC, Diez O, Alonso C, et al. 2003 Immunohistochemical characteristics defined by tissue microarray of hereditary breast cancer not attributable to BRCA1 or BRCA2 mutations: differences from breast carcinomas arising in BRCA1 and BRCA2 mutation carriers. *Clin Cancer Res* 9 3606-3614.

Pathania S, Bade S, Le Guillou M, Burke K, Reed R, Bowman-Colin C, Su Y, Ting DT, Polyak K, Richardson AL, et al. 2014 BRCA1 haploinsufficiency for replication stress suppression in primary cells. *Nat Commun* 5 5496.

Peng G & Lin SY 2011 Exploiting the homologous recombination DNA repair network for targeted cancer therapy. *World J Clin Oncol* 2 73-79.

Phuah SY, Looi LM, Hassan N, Rhodes A, Dean S, Taib NA, Yip CH & Teo SH 2012 Triple-negative breast cancer and PTEN (phosphatase and tensin homologue) loss are predictors of BRCA1 germline mutations in women with early-onset and familial breast cancer, but not in women with isolated late-onset breast cancer. *Breast Cancer Res* 14 R142.

Plon SE, Eccles DM, Easton D, Foulkes WD, Genuardi M, Greenblatt MS, Hogervorst FB, Hoogerbrugge N, Spurdle AB, Tavtigian SV, et al. 2008 Sequence variant classification and reporting: recommendations for improving the interpretation of cancer susceptibility genetic test results. *Hum Mutat* 29 1282-1291.

Proia TA, Keller PJ, Gupta PB, Klebba I, Jones AD, Sedic M, Gilmore H, Tung N,

Naber SP, Schnitt S, et al. 2011 Genetic predisposition directs breast cancer phenotype by dictating progenitor cell fate. *Cell Stem Cell* 8 149-163.

Rahman N, Seal S, Thompson D, Kelly P, Renwick A, Elliott A, Reid S, Spanova K, Barfoot R, Chagtai T, et al. 2007 PALB2, which encodes a BRCA2-interacting protein, is a breast cancer susceptibility gene. *Nat Genet* 39 165-167.

Rantakari P, Nikkilä J, Jokela H, Ola R, Pylkäs K, Lagerbohm H, Sainio K, Poutanen M & Winqvist R 2010 Inactivation of Palb2 gene leads to mesoderm differentiation defect and early embryonic lethality in mice. *Hum Mol Genet* 19 3021-3029.

Reid S, Renwick A, Seal S, Baskcomb L, Barfoot R, Jayatilake H, Pritchard-Jones K, Stratton MR, Ridolfi-Lüthy A, Rahman N, et al. 2005 Biallelic BRCA2 mutations are associated with multiple malignancies in childhood including familial Wilms tumour. *J Med Genet* 42 147-151.

Reid S, Schindler D, Hanenberg H, Barker K, Hanks S, Kalb R, Neveling K, Kelly P, Seal S, Freund M, et al. 2007 Biallelic mutations in PALB2 cause Fanconi anemia subtype FA-N and predispose to childhood cancer. *Nat Genet* 39 162-164.

Roy R, Chun J & Powell SN 2012 BRCA1 and BRCA2: different roles in a common pathway of genome protection. *Nat Rev Cancer* 12 68-78.

Saal LH, Gruvberger-Saal SK, Persson C, Lövgren K, Jumppanen M, Staaf J, Jönsson G, Pires MM, Maurer M, Holm K, et al. 2008 Recurrent gross mutations of the PTEN tumor suppressor gene in breast cancers with deficient DSB repair. *Nat Genet* 40 102-107.

Sakai W, Swisher EM, Karlan BY, Agarwal MK, Higgins J, Friedman C, Villegas E, Jacquemont C, Farrugia DJ, Couch FJ, et al. 2008 Secondary mutations as a mechanism of cisplatin resistance in BRCA2-mutated cancers. *Nature* 451 1116-1120.

Sandhu SK, Schelman WR, Wilding G, Moreno V, Baird RD, Miranda S, Hylands L, Riisnaes R, Forster M, Omlin A, et al. 2013 The poly(ADP-ribose) polymerase inhibitor niraparib (MK4827) in BRCA mutation carriers and patients with sporadic cancer: a phase 1 dose-escalation trial. *Lancet Oncol* 14 882-892.

Santarosa M & Ashworth A 2004 Haploinsufficiency for tumour suppressor genes: when you don't need to go all the way. *Biochim Biophys Acta* 1654 105-122.

Savage KI, Matchett KB, Barros EM, Cooper KM, Irwin GW, Gorski JJ, Orr KS, Vohhodina J, Kavanagh JN, Madden AF, et al. 2014 BRCA1 deficiency exacerbates estrogen-induced DNA damage and genomic instability. *Cancer Res* 74 2773-2784.

Savelyeva L, Claas A, Matzner I, Schlag P, Hofmann W, Scherneck S, Weber B &

Schwab M 2001 Constitutional genomic instability with inversions, duplications, and amplifications in 9p23-24 in BRCA2 mutation carriers. *Cancer Res* 61 5179-5185.

Sawyer SL, Tian L, Kähkönen M, Schwartzentruber J, Kircher M, Majewski J, Dymant DA, Innes AM, Boycott KM, Moreau LA, et al. 2015 Biallelic Mutations in BRCA1 Cause a New Fanconi Anemia Subtype. *Cancer Discov* 5 135-142.

Schlacher K, Christ N, Siaud N, Egashira A, Wu H & Jasin M 2011 Double-strand break repair-independent role for BRCA2 in blocking stalled replication fork degradation by MRE11. *Cell* 145 529-542.

Sharan SK, Morimatsu M, Albrecht U, Lim DS, Regel E, Dinh C, Sands A, Eichele G, Hasty P & Bradley A 1997 Embryonic lethality and radiation hypersensitivity mediated by Rad51 in mice lacking Brca2. *Nature* 386 804-810.

Shen SX, Weaver Z, Xu X, Li C, Weinstein M, Chen L, Guan XY, Ried T & Deng CX 1998 A targeted disruption of the murine Brca1 gene causes gamma-irradiation hypersensitivity and genetic instability. *Oncogene* 17 3115-3124.

Shen WH, Balajee AS, Wang J, Wu H, Eng C, Pandolfi PP & Yin Y 2007 Essential role for nuclear PTEN in maintaining chromosomal integrity. *Cell* 128 157-170.

Shen Y, Rehman FL, Feng Y, Boshuizen J, Bajrami I, Elliott R, Wang B, Lord CJ, Post LE & Ashworth A 2013 BMN 673, a novel and highly potent PARP1/2 inhibitor for the treatment of human cancers with DNA repair deficiency. *Clin Cancer Res* 19 5003-5015.

Slater EP, Langer P, Niemczyk E, Strauch K, Butler J, Habbe N, Neoptolemos JP, Greenhalf W & Bartsch DK 2010 PALB2 mutations in European familial pancreatic cancer families. *Clin Genet* 78 490-494.

Sonnenblick A, de Azambuja E, Azim HA & Piccart M 2015 An update on PARP inhibitors--moving to the adjuvant setting. *Nat Rev Clin Oncol* 12 27-41.

Sonoda E, Hohegger H, Saberi A, Taniguchi Y & Takeda S 2006 Differential usage of non-homologous end-joining and homologous recombination in double strand break repair. *DNA Repair (Amst)* 5 1021-1029.

Sorlie T, Tibshirani R, Parker J, Hastie T, Marron JS, Nobel A, Deng S, Johnsen H, Pesich R, Geisler S, et al. 2003 Repeated observation of breast tumor subtypes in independent gene expression data sets. *Proc Natl Acad Sci U S A* 100 8418-8423.

Southey MC, Teo ZL & Winship I 2013 PALB2 and breast cancer: ready for clinical translation! *Appl Clin Genet* 6 43-52.

Stefansson OA, Jonasson JG, Olafsdottir K, Bjarnason H, Th Johannsson O,

Bodvarsdottir SK, Valgeirsdottir S & Eyfjord JE 2011 Genomic and phenotypic analysis of BRCA2 mutated breast cancers reveals co-occurring changes linked to progression. *Breast Cancer Res* 13 R95.

Stracker TH, Roig I, Knobel PA & Marjanović M 2013 The ATM signaling network in development and disease. *Front Genet* 4 37.

Struewing JP, Hartge P, Wacholder S, Baker SM, Berlin M, McAdams M, Timmerman MM, Brody LC & Tucker MA 1997 The risk of cancer associated with specific mutations of BRCA1 and BRCA2 among Ashkenazi Jews. *N Engl J Med* 336 1401-1408.

Sverdlov RS, Barshack I, Bar Sade RB, Baruch RG, Hirsh-Yehezkel G, Dagan E, Feinmesser M, Figer A & Friedman E 2000 Genetic analyses of male breast cancer in Israel. *Genet Test* 4 313-317.

Sy SM, Huen MS & Chen J 2009 PALB2 is an integral component of the BRCA complex required for homologous recombination repair. *Proc Natl Acad Sci U S A* 106 7155-7160.

Tavtigian SV, Simard J, Rommens J, Couch F, Shattuck-Eidens D, Neuhausen S, Merajver S, Thorlacius S, Offit K, Stoppa-Lyonnet D, et al. 1996 The complete BRCA2 gene and mutations in chromosome 13q-linked kindreds. *Nat Genet* 12 333-337.

Teng LS, Zheng Y & Wang HH 2008 BRCA1/2 associated hereditary breast cancer. *J Zhejiang Univ Sci B* 9 85-89.

Teo ZL, Provenzano E, Dite GS, Park DJ, Apicella C, Sawyer SD, James PA, Mitchell G, Trainer AH, Lindeman GJ, et al. 2013 Tumour morphology predicts PALB2 germline mutation status. *Br J Cancer* 109 154-163.

Thompson D, Easton DF & Consortium BCL 2002 Cancer Incidence in BRCA1 mutation carriers. *J Natl Cancer Inst* 94 1358-1365.

Thorlacius S, Sigurdsson S, Bjarnadottir H, Olafsdottir G, Jonasson JG, Tryggvadottir L, Tulinius H & Eyfjörd JE 1997 Study of a single BRCA2 mutation with high carrier frequency in a small population. *Am J Hum Genet* 60 1079-1084.

Tischkowitz M, Xia B, Sabbaghian N, Reis-Filho JS, Hamel N, Li G, van Beers EH, Li L, Khalil T, Quenneville LA, et al. 2007 Analysis of PALB2/FANCN-associated breast cancer families. *Proc Natl Acad Sci U S A* 104 6788-6793.

Tischkowitz MD & Hodgson SV 2003 Fanconi anaemia. *J Med Genet* 40 1-10.

Tischkowitz MD, Sabbaghian N, Hamel N, Borgida A, Rosner C, Taherian N, Srivastava A, Holter S, Rothenmund H, Ghadirian P, et al. 2009 Analysis of the gene coding for the BRCA2-interacting protein PALB2 in familial and sporadic

pancreatic cancer. *Gastroenterology* 137 1183-1186.

Tsuda H, Fukutomi T & Hirohashi S 1995 Pattern of gene alterations in intraductal breast neoplasms associated with histological type and grade. *Clin Cancer Res* 1 261-267.

Tung N, Miron A, Schnitt SJ, Gautam S, Fettes K, Kaplan J, Yassin Y, Buraimoh A, Kim JY, Szász AM, et al. 2010 Prevalence and predictors of loss of wild type BRCA1 in estrogen receptor positive and negative BRCA1-associated breast cancers. *Breast Cancer Res* 12 R95.

Tutt A, Robson M, Garber JE, Domchek SM, Audeh MW, Weitzel JN, Friedlander M, Arun B, Loman N, Schmutzler RK, et al. 2010 Oral poly(ADP-ribose) polymerase inhibitor olaparib in patients with BRCA1 or BRCA2 mutations and advanced breast cancer: a proof-of-concept trial. *Lancet* 376 235-244.

Tutt AN, Lord CJ, McCabe N, Farmer H, Turner N, Martin NM, Jackson SP, Smith GC & Ashworth A 2005 Exploiting the DNA repair defect in BRCA mutant cells in the design of new therapeutic strategies for cancer. *Cold Spring Harb Symp Quant Biol* 70 139-148.

van der Groep P, van der Wall E & van Diest PJ 2011 Pathology of hereditary breast cancer. *Cell Oncol (Dordr)* 34 71-88.

Venkitaraman AR 2001 Functions of BRCA1 and BRCA2 in the biological response to DNA damage. *J Cell Sci* 114 3591-3598.

Venkitaraman AR 2014 Cancer suppression by the chromosome custodians, BRCA1 and BRCA2. *Science* 343 1470-1475.

Vousden KH & Prives C 2009 Blinded by the Light: The Growing Complexity of p53. *Cell* 137 413-431.

Walsh CS, Ogawa S, Scoles DR, Miller CW, Kawamata N, Narod SA, Koeffler HP & Karlan BY 2008 Genome-wide loss of heterozygosity and uniparental disomy in BRCA1/2-associated ovarian carcinomas. *Clin Cancer Res* 14 7645-7651.

Wang HC, Chou WC, Shieh SY & Shen CY 2006 Ataxia telangiectasia mutated and checkpoint kinase 2 regulate BRCA1 to promote the fidelity of DNA end-joining. *Cancer Res* 66 1391-1400.

Wang ZQ, Auer B, Stingl L, Berghammer H, Haidacher D, Schweiger M & Wagner EF 1995 Mice lacking ADPRT and poly(ADP-ribosyl)ation develop normally but are susceptible to skin disease. *Genes Dev* 9 509-520.

Weiss JR, Moysich KB & Swede H 2005 Epidemiology of male breast cancer. *Cancer Epidemiol Biomarkers Prev* 14 20-26.

Welsh PL & King MC 2001 BRCA1 and BRCA2 and the genetics of breast and ovarian cancer. *Hum Mol Genet* 10 705-713.

Xia B, Sheng Q, Nakanishi K, Ohashi A, Wu J, Christ N, Liu X, Jasin M, Couch FJ & Livingston DM 2006 Control of BRCA2 cellular and clinical functions by a nuclear partner, PALB2. *Mol Cell* 22 719-729.

Xia F, Taghian DG, DeFrank JS, Zeng ZC, Willers H, Iliakis G & Powell SN 2001 Deficiency of human BRCA2 leads to impaired homologous recombination but maintains normal nonhomologous end joining. *Proc Natl Acad Sci U S A* 98 8644-8649.

Ye Q, Hu YF, Zhong H, Nye AC, Belmont AS & Li R 2001 BRCA1-induced large-scale chromatin unfolding and allele-specific effects of cancer-predisposing mutations. *J Cell Biol* 155 911-921.

Yu VP, Koehler M, Steinlein C, Schmid M, Hanakahi LA, van Gool AJ, West SC & Venkitaraman AR 2000 Gross chromosomal rearrangements and genetic exchange between nonhomologous chromosomes following BRCA2 inactivation. *Genes Dev* 14 1400-1406.

Yuan SS, Lee SY, Chen G, Song M, Tomlinson GE & Lee EY 1999 BRCA2 is required for ionizing radiation-induced assembly of Rad51 complex in vivo. *Cancer Res* 59 3547-3551.

Zhang F, Ma J, Wu J, Ye L, Cai H, Xia B & Yu X 2009 PALB2 links BRCA1 and BRCA2 in the DNA-damage response. *Curr Biol* 19 524-529.

Zhu Q, Pao GM, Huynh AM, Suh H, Tonnu N, Nederlof PM, Gage FH & Verma IM 2011 BRCA1 tumour suppression occurs via heterochromatin-mediated silencing. *Nature* 477 179-184.

Capítulo IX. The landscape of somatic genetic alterations in BRCA1 and BRCA2 breast cancers.

Artigo em preparação para o periódico *Breast Cancer Research*.

The landscape of somatic genetic alterations in BRCA1 and BRCA2 breast cancers

Gabriel S Macedo^{1,2}, Kathleen A Burke¹, Salvatore Piscuoglio¹, Charlotte K Y Ng¹, Felipe C Geyer¹, Luciano G Martelotto¹, Anastasios D Papanastatiou¹, Maria R de Filippo¹, Anne M Schultheis¹, Edi Brogi¹, Mark Robson¹, Hannah Y. Wen¹, Britta Weigelt¹ and Jorge S Reis-Filho¹

¹Memorial Sloan Kettering Cancer Center, New York, NY, USA

²Post-Graduate Program in Genetics and Molecular Biology, Universidade Federal do Rio Grande do Sul (UFRGS), Porto Alegre, 15053, Rio Grande do Sul, Brazil;

Correspondence:

Dr. Jorge S. Reis-Filho, MD PhD FRCPATH, Department of Pathology, Memorial Sloan Kettering Cancer Center, 1275 York Avenue, New York, NY 10065, USA. Phone: +1 212 639 8054. E-mail: reisfilj@mskcc.org

Conflict of interest: The authors have no conflict of interest to declare.

ABSTRACT

Background: *BRCA1* and *BRCA2* germline mutations account for a substantial proportion of hereditary breast cancers (BCs). The majority of *BRCA1*-associated breast tumors are of triple-negative phenotype (estrogen receptor (ER)-, progesterone receptor (PR)- and HER2-negative) and harbor *TP53* somatic mutations. In contrast, *BRCA2*-associated cancers are less homogeneous and often ER-positive. Systematic analyses of the landscape of somatic genomic alterations in *BRCA1*- and *BRCA2*-BCs have yet to be reported. Here we sought to determine the repertoire of somatic mutations and copy number alterations (CNAs) in BCs occurring in patients with *BRCA1* and *BRCA2* germline mutations.

Methods: DNA extracted from microdissected frozen tumor-normal pairs of 29 *BRCA1*- and 10 *BRCA2* BCs was subjected to breast cancer targeted sequencing panel or Integrated Mutation Profiling of Actionable Cancer Targets (MSK-IMPACT) assay. Publicly available data of 8 *BRCA1* and 7 *BRCA2* breast tumors were also included. Somatic single nucleotide variants, small insertions and deletions, CNAs and the cancer cell fraction (CCF) of each alteration were defined using state of the art bioinformatics algorithms.

Results: 70.3% (26/37) and 18.9% (7/37) of *BRCA1*-BCs were triple-negative and ER-positive/HER2-negative, respectively. Within *BRCA2* cases, 88.2% (15/17) were ER-positive and four HER2-positives. The majority of tumors arising in *BRCA1* mutation carriers harbored *TP53* clonal somatic mutations (26/37, 70.3%) and loss of *BRCA1* wild-type allele was found to be clonal and subclonal in 73% and 19%, respectively. Interestingly, the tumors lacking these alterations were most likely ER-positive. In *BRCA2*-BCs, 15 out of 17 (88.2%) displayed loss of the *BRCA2* wild-type allele (14 clonal and 1 subclonal) and recurrent mutations affected *TP53* and *GATA3* genes. Subclonal mutations in known cancer genes were observed in both *BRCA1*- and *BRCA2*-related cancers, suggesting intra-tumor genetic heterogeneity.

Conclusions: *BRCA1*- and *BRCA2*-BCs are mostly characterized by clonal inactivation of *BRCA1/2* wild-type allele, which likely constitute early genetic events. Within *BRCA1*-breast cancers, *TP53* mutations are highly recurrent and mostly clonal, and may precede somatic loss of the *BRCA1* wild-type allele, as the latter was subclonal in some cases harboring a clonal *TP53* somatic mutation.

INTRODUCTION

Hereditary Breast and Ovarian Cancer (HBOC) due to germline mutations in either *BRCA1* or *BRCA2* genes is the most common cause of hereditary breast cancer (BC) [1]. The overall prevalence of *BRCA1/2* mutation carriers is estimated to be from 1 in 400-800 individuals of the general population, but varies considerably between ethnic groups [2]. For instance, in the Ashkenazi Jewish population founder mutations in both *BRCA1* and *BRCA2* genes are found in over 2% of individuals [3, 4]. Although the penetrance appears to be variable within families, an average BC risk of about 65% and 45% by age 70 years has been estimated in *BRCA1* and *BRCA2* mutation carriers, respectively [5].

It is well known that the protein products of *BRCA1* and *BRCA2* genes play a critical role in the repair of DNA double-strand breaks through homologous recombination (HR) [6]. Thus, it is believed that *BRCA1/2* germline mutation coupled to somatic loss of the wild-type allele result in HR DNA repair deficiency and this is treatment-predictive for response to poly (ADP) ribose polymerase (PARP) inhibitors and platinum-based chemotherapy [7]. Despite advances, currently the repertoire of systemic therapies for patients carrying *BRCA1/2* germline mutation does not differ from that of patients with sporadic disease of the same estrogen receptor (ER), progesterone receptor (PR) and human epidermal growth factor 2 (HER2) status [8].

Despite being driven by functionally related genes, *BRCA1*- and *BRCA2*-BCs (*BRCA*-BCs) constitute a heterogeneous group of tumors phenotypically and at the genetic level [9]. In this context, about 70% of the tumors arising in *BRCA1* mutation carriers display a triple-negative phenotype (ER-negative, PR-negative and HER2-negative) [10-12]. In contrast, *BRCA2*-BCs are less homogeneous and often ER-positive [11, 13]. At base pair resolution, massively parallel sequencing (MPS) analyses of *BRCA*-BCs carried out to date have demonstrated, in a small number of tumors, that the repertoire of somatic mutations of these cancers harbor is diverse [14, 15].

For decades it has been assumed that *BRCA1* and *BRCA2* are bona fide tumor suppressor genes, whose loss-of-function follows the two-hit model [16]. However, recent data have suggested that in some *BRCA*-BCs, the *BRCA1* wild-

type allele is preserved in a subset of cancer cells, and that a minority of BRCA1-BCs may not display loss of *BRCA1* wild-type allele at all [17, 18]. Restoration of BRCA1/2 function at later stages of disease, in particular after therapy, has also been demonstrated [19-21]. In this context, intragenic deletions and/or revertant mutations that restore the function of BRCA1/2, possibly restricted to a subset of cells within these cancers, have been shown to result in resistance to platinum salts and PARP inhibitors, and not to revert the malignant phenotype. These observations suggest that BRCA-BCs are likely be composed of mosaics of tumor cells that in addition to the founder genetic event (i.e. germline *BRCA1/2* mutation) harbor private genetic alterations.

Although advances, it should be noted that no systematic analyses of the repertoire and chronology of somatic genetic events in BRCA-BCs have been performed as yet. Moreover, the frequency of loss of the *BRCA* wild-type allele and its association with other molecular alterations is poorly understood. Thus, in this study we aimed to determine the repertoire of copy number alterations (CNAs) and somatic mutations as well as to infer the cancer cell fraction (CCF) of each somatic mutation and *BRCA1/2* loss of wild-type allele in BCs occurring in patients with *BRCA1* or *BRCA2* germline mutations.

MATERIAL AND METHODS

Cases

Fresh frozen tumor and matched normal tissue from 29 *BRCA1* and 10 *BRCA2* mutation carriers were retrieved from the pathology files of Memorial Sloan Kettering Cancer Center (MSKCC) in New York. All tissue samples were derived from treatment-naïve patients and histologic slides were reviewed by two pathologists (HYW and JSR-F) with expertise in breast pathology. Samples were anonymized prior to analysis and approval for the use of these samples was granted by Institutional Review Board (IRB) of MSKCC. Clinico-pathologic features of breast tumors arising in *BRCA1/2* mutation carriers are summarized in **Figure 1, 2** and **Supplementary Table S1**. Re-analysis of publicly available exome massively parallel sequencing datasets for 15 BRCA-associated breast tumours (8

BRCA1 and 7 BRCA2) were obtained from The Cancer Genome Atlas (TCGA) project.

ER, PR and HER2 assessment

Immunohistochemical profile of tumors was assessed on 4 μ m-thick sections, using antibodies against estrogen receptor (ER), progesterone receptor (PR) and HER2 as previously described [22]. Positive and negative controls were included in each experiment. The ER, PR, and HER2 immunohistochemical results were evaluated by four pathologists (HYW, ADP, FCG and JSR-F) according to the American Society of Clinical Oncology (ASCO)/ College of American Pathologists (CAP) guidelines [23, 24]. For equivocal cases *HER2* gene amplifications was assessed by FISH testing [25].

Microdissection and DNA extraction

Eight μ m-thick frozen sections from each case (tumor and normal) were cut and stained with hematoxylin-eosin (H&E) and also DNase- and RNase-free nuclear fast red. Regions of tumor that are identified by four pathologists (ADP, AMS, FCG and JSR-F) were subjected to microdissection with a needle under a stereomicroscope (Olympus SZ61, Tokyo, Japan) as previously described [26], in order to ensure >90% of tumor cell content. DNeasy Blood and Tissue Kit (Qiagen) was used for DNA extraction, according to the manufacturer's guidelines. DNA extracted from normal and tumor tissue was quantified using the Qubit Fluorometer assay (Life Technologies).

Targeted capture massively parallel sequencing (MPS)

Whole exome MPS (WES) and targeted capture massively parallel sequencing (MPS) using either a breast cancer targeted sequencing assay or the Integrated Mutation Profiling of Actionable Cancer Targets (MSK-IMPACT) assay [27] were performed on matched tumor and normal DNA samples from fifteen, eighteen and twenty one germline BRCA mutant breast cancers, respectively (Sequencing Statistics Table). The WES samples were used from the publicly

available data from the TCGA, and processed according to their guidelines as previously described [28]. The aligned BAMs were downloaded and processed with our state-of-the-art pipeline (described below). The median depth of coverage for the WES was 115.31x (91.58 - 156.93x) for the tumor samples and 113.2x (range 87.25 - 171.48x) for the matched normal samples. For the remaining samples tumor and germline DNA were subjected to targeted capture massively parallel sequencing (MPS) using an Illumina HiSeq 2500 instrument at the MSKCC Integrated Genomics Operation (IGO) following validated protocols. Genome Analysis Toolkit (GATK) was used for local realignment to human reference genome GRCh37, duplicate removal and quality score recalibration [29]. The median depth of coverage for MSK-IMPACT was 667.39x (395.49 - 923.66x) for the tumor samples and 442.51x (102.40- 561.81x) for the matched normal samples. The median depth of coverage for the targeted sequencing assay was 139.25x (13.4 - 721.98x) for the tumor samples and 187.09x (15.04 - 456.53x) for the matched normal samples.

Somatic single nucleotide variants (SNVs) were identified using MuTect [30]; small insertions and deletions (indels) were identified using Strelka and VarScan 2 [31, 32], and further curated by manual inspection. Small insertions and deletions (indels) were detected using Strelka (v2.0.15) [32] and VarScan 2 (v2.3.7) [33]. We filtered out SNVs and indels outside of the target regions, those with mutant allelic fraction (MAF) of <1% and/or those supported by ≤ 5 reads [34]. We further excluded SNVs and indels for which the tumor MAF was <5 times that of the matched normal MAF, as well as SNVs and indels found at >5% global minor allele frequency of dbSNP (build 137).

A combination of Mutation Taster [35], CHASM (breast) [36] and FATHMM [37] was used to define the potential functional effect of each non-synonymous SNV. Missense SNVs defined as non-deleterious/passenger by both MutationTaster [35] and CHASM (breast) [36], a combination of mutation function predictors shown to have a high negative predictive value [38], were considered passenger alterations. Additionally, mutations that were not predicted by CHASM (breast classifier) and/ or FATHMM [39] as “driver” and/ or “cancer” alterations, respectively, were classified as passenger alterations. The SNVs considered not

to be passengers using this combination of mutation function predictors were defined as “likely-pathogenic” if they affected cancer genes included in the cancer gene lists described by Kandoth et al. (127 significantly mutated genes) [40], the Cancer Gene Census [41] or Lawrence et al. (Cancer5000-S gene set) [42], or were otherwise classified as “potentially-pathogenic”. For in-frame indels, those that were defined as “deleterious” by MutationTaster or PROVEAN [43], and targeted by LOH of the wild-type allele or affected cancer genes included in the cancer gene lists were considered to be “potentially-pathogenic”. In-frame indels that both affected genes within the cancer genes list and had LOH were considered “likely-pathogenic”. Frameshift, splice-site and truncating mutations in the presence of LOH of the wild-type allele or affected genes of at least one of the three cancer gene datasets were considered likely pathogenic.

The cancer cell fraction (CCF) of each mutation was inferred using the number of reads supporting the reference and the alternate alleles and the segmented Log_2 ratio from MPS as input for ABSOLUTE (v1.0.6) [44]. Solutions from ABSOLUTE were manually reviewed as recommended [44, 45]. A mutation was classified as clonal if its probability of being clonal was $>50\%$ [45] or if the lower bound of the 95% confidence interval of its CCF was $>90\%$. Mutations that did not meet the above criteria were considered subclonal.

Copy number analysis

FACETS [46] was employed to determine copy number alterations (CNAs). Read counts for dbSNP (build 137) positions within the target regions were generated for matched tumor and normal samples, and used as input to FACETS for analysis as previously described [47]. Loss of heterozygosity (LOH) was determined using the minor copy number estimates of each segment for genes harboring a somatic mutation. All gene amplifications, homozygous deletions and LOH were visually inspected using plots of raw Log_2 and allelic copy ratios. FACETS tumor purity estimates were used to determine the clonality of BRCA LOH and local copy number estimates were used for the calculation of large-scale transitions [48].

Results

Clinico-pathologic features of BRCA-BCs

Figure 1, 2 and Supplementary Table S1 summarizes the clinical and morphological features as well as the immunohistochemical profile of the series of hereditary breast carcinomas included in this study. With regard to ER, PR and HER2 status, 70.3% (26/37) and 18.9% (7/37) of *BRCA1*-cancers were triple-negative and ER-positive/HER2-negative, respectively. Within *BRCA2*-associated tumors, 88.2% (15/17) were ER-positive and four HER2-positives (**Table 1, 2 and Supplementary Table S1**).

Genomic landscape of BRCA1/2-associated breast tumors

Massively parallel sequencing of BRCA-BCs resulted in the identification of 2206 somatic mutations affecting 1732 different genes. Of the 2206 mutations detected, 1775 (80.5%) were non-synonymous SNVs. MPS revealed a median of three (range 1-6) and two (range 0-5) non-synonymous mutations in *BRCA1* and *BRCA2* cases, respectively, when considered only the 227 genes present in the three target capture panels (**Supplementary Table S1**).

In *BRCA1* breast tumors recurrently mutated genes included *TP53*, *KMT2C*, *NF1*, *GRIN2A*, *AKT3*, *MAP2K2* and *PTEN*. The most frequently mutated gene in the cohort was *TP53*, with somatic mutations being found in 26 out of 37 (70.3%) of the tumors. Tumors lacking *TP53* loss-of-function mutations were most likely ER-positive (7/11, 63.6%), and in two cases a *PIK3CA* hotspot mutation (E545K and R1047H) was observed (**Figure 1**). In contrast to *BRCA1* cases, *TP53* somatic mutations were found in lower frequency in *BRCA2*-BCs (17.6%, 3/17). Moreover, few recurrently mutated genes were identified in these tumors (e.g *GATA3*) (**Figure 2**).

Additional likely pathogenic mutations in *bona fide* cancer genes, such as *EGFR*, *NF1*, *PIK3R1*, *RB1*, *BRCA2*, *FOXA1* and *FGFR2* were identified in single or few cases (**Figure 1 and 2**). Somatic mutations in most of tumor suppressor genes, including *TP53*, *BRCA2*, *NF1*, *PTEN* and *ATM* were coupled to loss of heterozygosity. Loss of heterozygosity (LOH) of the *TP53* wild-type allele was observed in 100% of cases (**Figure 3 and 4**).

Copy number analysis revealed that BRCA1- and BRCA2-BCs share several recurrent gains and losses. The most common CNAs in BRCA1-BCs were losses of 1p36 and gains of 1q21, 1q42-43, 3q26 (encompassing *PIK3CA*), 6p22 (*HIST1H* family genes) and 11q13 (encompassing *CCND1*) (**Figure 5a**). Homozygous deletions of *NF1*, *PTEN*, *CDKN1B*, *CDKN2A*, *RB1*, *CHEK1* and *RAD51* were observed in single BRCA1 cases (**Figure 1**). In BRCA2 tumors, losses of 1p36 (encompassing *ARID1A* and *MTOR*), 3p21, 11q22 (encompassing *ATM*), 22q12 (encompassing *NF1* and *CHEK2*) as well as gains in 1q32 and 15q26 (encompassing *IDH2* and *BLM*) were found to be recurrent (**Figure 5b**).

Clonal heterogeneity of BRCA tumors

We then investigated the fraction of cancer cells harboring *BRCA1/2* LOH. Our analysis revealed that *BRCA1* LOH was found in 34 out of 37 cases (91.9%), being clonal (i.e. inferred to be present in virtually all cancer cells analyzed in a given sample) in 91.9% (27/34) and subclonal in 20.6% (7/34) of the cases. Two of the three BRCA1 breast tumors that did not show *BRCA1* LOH were ER-positive and also developed in the absence of *TP53* somatic mutation. Interestingly, two of these cases harbored a second *BRCA1* somatic mutation (K1657fs and Q934*), of which the latter was clonal (**Figure 1 and 3**). Within *BRCA2*-BCs, clonal and subclonal *BRCA2* LOH was found in 82.3% (14/17) and 5.9% (1/17) of the cases. Two of these breast cancers were inferred to preserve the *BRCA2* wild-type allele (**Figure 2 and 4**).

The majority of the somatic mutations found in known cancer genes harboring a likely pathogenic mutation, such as *TP53*, *PIK3CA*, *PIK3R1*, *BRCA2*, *ATM* and *RB1* were predicted as clonal, while subclonal mutations in others (e.g. *GATA3* and *PTEN*) were also identified, suggesting intra-tumor heterogeneity (**Figure 3 and 4**).

Discussion

Histological and molecular studies have revealed the heterogeneous nature of BC [12, 49]. Breast tumors in patients carrying a *BRCA1* or *BRCA2* germline mutation, however, offer an interesting opportunity to study genetic heterogeneity,

given that it has been posited that the order of genetic aberrations in cancer development determines the subsequent repertoire of somatic genetic aberrations [50]. Moreover, although BRCA1- and BRCA2-related BC represent the most common form of hereditary breast tumors, just a few genomic studies, in a small number of tumors, were carried out to date [14, 15] and no systematic analyses of the repertoire of somatic mutations and clonal heterogeneity in these cancers have been performed as yet. In this study we used target capture MPS to determine the catalog of somatic genetic events and the extent of intra-tumor genetic heterogeneity in BRCA-BCs.

It is well-known that around 80% of the BRCA1-BCs display a triple-negative phenotype and are classified as basal-like molecular subtype [51, 52]. In fact, several lines of evidence have demonstrated that BRCA1 directly modulates ER expression in BCs and also that these tumors originate from ER-negative luminal progenitor cells [53-56]. However, at least 20% of all breast tumors arising in *BRCA1* germline mutation carriers express ER [11]. Some authors argue that these cancers are not linked to *BRCA1* germline mutations, but most likely constitute sporadic ER-positive tumors [18]. In our cohort, 9 out of 37 (24.3%) of the BRCA1 cases were ER-positive. Interestingly, within this group of tumors, seven cases were not affected by *TP53* somatic mutations and two developed in the absence of *BRCA1* LOH. In fact, Manié *et al.* observed lower frequency of *TP53* somatic mutation in *BRCA1* luminal tumors when compared to basal-like carcinomas [57]. Taken together, we can hypothesize that within ER-positive BRCA1-BCs two subgroups are found, including those sharing common features of BRCA-related cancers and others less likely to have *BRCA*-associated features, raising the possibility of incidental etiology in the latter.

Notably, the notion of the BRCA1 and BRCA2 functions on DNA repair of double-strand breaks through homologous recombination (HR) and the impact of complete BRCA deficiency within tumors allowed to advance in terms of therapeutic approaches for this subgroup of patients [58]. Moreover, although loss of the *BRCA1* wild-type allele was thought to be the tumor-initiating event in patients with heterozygous germline mutations [16, 59], evidences showing that some tumors or a subset of cells within tumors preserve the *BRCA1/2* wild-type

allele called into question the “two-hit” model and raised concerns about the efficacy of treatments targeting HR. Consistent with this notion, Pethania *et al.* demonstrated that mammary epithelial cells and fibroblasts from *BRCA1*^{mut/+} exhibited normal double-strand break repair by HR [60]. Observations that genetic inactivation of *BRCA1* in cultured cells induces a rapid proliferation arrest, and that homozygous *Brca1*^{-/-} mice display early embryonic lethality [61, 62], strongly suggesting that additional genetic alterations are required prior to loss of the remaining wild-type *BRCA1* allele. Although somatic loss of *BRCA1* and *BRCA2* wild-type allele has been found in the majority of tumors [17, 63], our results confirm by MPS that a subset of BRCA1/2-associated BCs may develop in the absence of clonal *BRCA1/2* LOH and a minority of these tumors did not display *BRCA1/2* LOH at all. Importantly, cells which retain the wild-type allele, or harbor intragenic deletions and/or revertant mutations, are unlikely to be sensitive to therapies that target DNA repair-deficiency, including inhibitors of the Poly(ADP-ribose) polymerase (PARP).

Here we showed that *TP53* mutations were observed in about 70% of BRCA1-breast cancers. In agreement with this, seminal studies have provided evidence to suggest that *BRCA1* and *TP53* are in epistatic interaction and promote synthetic viability (Ashworth, 2011), given that loss of p53 prolongs the embryonic survival of *Brca1*-knockout mice. Our data derived from deep exome and/ or targeted capture massively parallel sequencing of these BRCA1-BCs also suggest that, in addition to the high frequency of *TP53* loss of function, truncal loss of specific tumor suppressor genes (e.g. *PTEN*, *RB1*, *CDKN2A*, *NF1*, *RPTOR* and *MAP2K2*) may be recurrent events in BRCA1-BC. However, questions that are germane to the understanding of BRCA1-BC include whether these putative truncal events precede loss of the remaining BRCA1 wild-type allele, and whether they influence the viability of BRCA1-deficient cells.

Despite being driven by germline mutations in functionally related genes, we observed that BRCA1- and BRCA2-mutated BCs constitute a heterogeneous group of tumors at the molecular level. In agreement with previously findings [57, 64], we observed high frequency of *TP53* somatic mutation in BRCA1 cases, but not in BRCA2. Our data also indicate a heterogeneous pattern of subclonal

diversification, in which some tumors are predominantly composed by clonal mutations, in contrast to others that harbor a high number of subclonal mutations. Moreover, although the high levels of genomic instability recently described in cancers with *BRCA1* and *BRCA2* inactivating mutation [25, 63], quite surprisingly is the small number of likely pathogenic mutation found in some BRCA tumors.

In conclusion, our data demonstrate that BRCA1 and BRCA2 breast tumors share partial similarities in their mutational repertoire. Moreover, clonal *TP53* somatic mutation was the only recurrent mutated gene and may precede *BRCA1* and *BRCA2* LOH, allowing tumor cells survive to complete loss of BRCA1. Additionally, our data also suggest that in at least a subset of BRCA1/2-BCs, other driver genetic events may have preceded the loss of *BRCA* wild-type allele.

FIGURE LEGENDS

Figure 1. Repertoires of mutations, gene amplifications and homozygous deletions of BRCA1-associated breast tumors. Heatmap indicating the non-synonymous somatic mutations, amplifications and homozygous deletions in the 37 BRCA1 breast tumors analyzed. Each column represents one sample and rows show genes. Alteration types are color-coded according to the legend. Diagonal bar was used to represent loss of heterozygosity (LOH) of the wild-type allele of a mutated gene. Only the 227 genes present in the three target capture panels were included. Expression of ER, PR and HER2 as defined by immunohistochemistry, BRCA1 LOH clonality and large-scale state transitions (LST) score are shown on figure.

Figure 2. Repertoires of mutations, gene amplifications and homozygous deletions of BRCA2-associated breast tumors. Heatmap indicating the non-synonymous somatic mutations, amplifications and homozygous deletions in the 17 BRCA2 breast tumors analyzed. Each column represents one sample and rows show genes. Alteration types are color-coded according to the legend. Diagonal bar was used to represent loss of heterozygosity (LOH) of the wild-type allele of a mutated gene. Only the 227 genes present in the three target capture panels were

included. Expression of ER, PR and HER2 as defined by immunohistochemistry, BRCA2 LOH clonality and large-scale state transitions (LST) score.

Figure 3. Cancer cell fraction of every non-synonymous mutation found in BRCA1 breast tumors. Integrated analysis of mutant allele fractions, tumor cell content, ploidy and local copy number using ABSOLUTE was performed to determine the cancer cell fractions (CCFs) of every non-synonymous. CCFs are color-coded according to the legend.

Figure 4. Cancer cell fraction of every non-synonymous mutation found in BRCA2 breast tumors. Integrated analysis of mutant allele fractions, tumor cell content, ploidy and local copy number using ABSOLUTE was performed to determine the cancer cell fractions (CCFs) of every non-synonymous. CCFs are color-coded according to the legend.

Figure 5. Copy number alterations of BRCA1- and BRCA2-associated breast cancers. (a) Frequency of copy number gains, losses, amplifications and homozygous deletions of 37 BRCA1 and 17 BRCA2 breast tumors subjected to target capture massively parallel sequencing are shown on the top and bottom, respectively.

REFERENCES

1. Castéra L, Krieger S, Rousselin A, Legros A, Baumann JJ, Bruet O, Brault B, Fouillet R, Goardon N, Letac O *et al*: **Next-generation sequencing for the diagnosis of hereditary breast and ovarian cancer using genomic capture targeting multiple candidate genes.** *Eur J Hum Genet* 2014, **22**(11):1305-1313.
2. Whittemore AS, Gong G, Itnyre J: **Prevalence and contribution of BRCA1 mutations in breast cancer and ovarian cancer: results from three U.S. population-based case-control studies of ovarian cancer.** *Am J Hum Genet* 1997, **60**(3):496-504.
3. Struwing JP, Hartge P, Wacholder S, Baker SM, Berlin M, McAdams M, Timmerman MM, Brody LC, Tucker MA: **The risk of cancer associated with specific mutations of BRCA1 and BRCA2 among Ashkenazi Jews.** *N Engl J Med* 1997, **336**(20):1401-1408.
4. Gabai-Kapara E, Lahad A, Kaufman B, Friedman E, Segev S, Renbaum P, Beeri R, Gal M, Grinshpun-Cohen J, Djemal K *et al*: **Population-based screening for breast and ovarian cancer risk due to BRCA1 and BRCA2.** *Proc Natl Acad Sci U S A* 2014, **111**(39):14205-14210.
5. Antoniou A, Pharoah PD, Narod S, Risch HA, Eyfjord JE, Hopper JL, Loman N, Olsson H, Johannsson O, Borg A *et al*: **Average risks of breast and ovarian cancer associated with BRCA1 or BRCA2 mutations detected in case Series unselected for family history: a combined analysis of 22 studies.** *Am J Hum Genet* 2003, **72**(5):1117-1130.
6. Powell SN, Kachnic LA: **Roles of BRCA1 and BRCA2 in homologous recombination, DNA replication fidelity and the cellular response to ionizing radiation.** *Oncogene* 2003, **22**(37):5784-5791.
7. Maxwell KN, Domchek SM: **Cancer treatment according to BRCA1 and BRCA2 mutations.** *Nat Rev Clin Oncol* 2012, **9**(9):520-528.
8. Smith KL, Isaacs C: **BRCA mutation testing in determining breast cancer therapy.** *Cancer J* 2011, **17**(6):492-499.
9. Armes JE, Trute L, White D, Southey MC, Hammet F, Tesoriero A, Hutchins AM, Dite GS, McCredie MR, Giles GG *et al*: **Distinct molecular pathogenesis of early-onset breast cancers in BRCA1 and BRCA2 mutation carriers: a population-based study.** *Cancer Res* 1999, **59**(8):2011-2017.
10. Badve S, Dabbs DJ, Schnitt SJ, Baehner FL, Decker T, Eusebi V, Fox SB, Ichihara S, Jacquemier J, Lakhani SR *et al*: **Basal-like and triple-negative breast cancers: a critical review with an emphasis on the implications for pathologists and oncologists.** *Mod Pathol* 2011, **24**(2):157-167.
11. Mavaddat N, Barrowdale D, Andrulis IL, Domchek SM, Eccles D, Nevanlinna H, Ramus SJ, Spurdle A, Robson M, Sherman M *et al*: **Pathology of breast and ovarian cancers among BRCA1 and BRCA2 mutation carriers: results from the Consortium of Investigators of Modifiers of BRCA1/2 (CIMBA).** *Cancer Epidemiol Biomarkers Prev* 2012, **21**(1):134-147.
12. Sorlie T, Tibshirani R, Parker J, Hastie T, Marron JS, Nobel A, Deng S, Johnsen H, Pesich R, Geisler S *et al*: **Repeated observation of breast tumor subtypes in independent gene expression data sets.** *Proc Natl Acad Sci U S A* 2003, **100**(14):8418-8423.
13. Melchor L, Honrado E, García MJ, Alvarez S, Palacios J, Osorio A, Nathanson KL, Benítez J: **Distinct genomic aberration patterns are found in familial breast cancer associated with different immunohistochemical subtypes.** *Oncogene* 2008, **27**(22):3165-3175.
14. Natrajan R, Mackay A, Lambros MB, Weigelt B, Wilkerson PM, Manie E, Grigoriadis A, A'hern R, van der Groep P, Kozarewa I *et al*: **A whole-genome massively parallel sequencing analysis of BRCA1 mutant oestrogen receptor-negative and -positive breast cancers.** *J Pathol* 2012, **227**(1):29-41.

15. Nik-Zainal S, Alexandrov LB, Wedge DC, Van Loo P, Greenman CD, Raine K, Jones D, Hinton J, Marshall J, Stebbings LA *et al*: **Mutational processes molding the genomes of 21 breast cancers.** *Cell* 2012, **149**(5):979-993.
16. Narod SA, Foulkes WD: **BRCA1 and BRCA2: 1994 and beyond.** *Nat Rev Cancer* 2004, **4**(9):665-676.
17. Martins FC, De S, Almendro V, Gönen M, Park SY, Blum JL, Herlihy W, Ethington G, Schnitt SJ, Tung N *et al*: **Evolutionary pathways in BRCA1-associated breast tumors.** *Cancer Discov* 2012, **2**(6):503-511.
18. Tung N, Miron A, Schnitt SJ, Gautam S, Fetten K, Kaplan J, Yassin Y, Buraimoh A, Kim JY, Szász AM *et al*: **Prevalence and predictors of loss of wild type BRCA1 in estrogen receptor positive and negative BRCA1-associated breast cancers.** *Breast Cancer Res* 2010, **12**(6):R95.
19. Edwards SL, Brough R, Lord CJ, Natrajan R, Vatcheva R, Levine DA, Boyd J, Reis-Filho JS, Ashworth A: **Resistance to therapy caused by intragenic deletion in BRCA2.** *Nature* 2008, **451**(7182):1111-1115.
20. Sakai W, Swisher EM, Karlan BY, Agarwal MK, Higgins J, Friedman C, Villegas E, Jacquemont C, Farrugia DJ, Couch FJ *et al*: **Secondary mutations as a mechanism of cisplatin resistance in BRCA2-mutated cancers.** *Nature* 2008, **451**(7182):1116-1120.
21. Swisher EM, Sakai W, Karlan BY, Wurz K, Urban N, Taniguchi T: **Secondary BRCA1 mutations in BRCA1-mutated ovarian carcinomas with platinum resistance.** *Cancer Res* 2008, **68**(8):2581-2586.
22. Guerini-Rocco E, Hodi Z, Piscuoglio S, Ng CK, Rakha EA, Schultheis AM, Marchio C, da Cruz Paula A, De Filippo MR, Martelotto LG *et al*: **The repertoire of somatic genetic alterations of acinic cell carcinomas of the breast: an exploratory, hypothesis-generating study.** *The Journal of pathology* 2015.
23. Hammond ME, Hayes DF, Dowsett M, Allred DC, Hagerty KL, Badve S, Fitzgibbons PL, Francis G, Goldstein NS, Hayes M *et al*: **American Society of Clinical Oncology/College Of American Pathologists guideline recommendations for immunohistochemical testing of estrogen and progesterone receptors in breast cancer.** *Journal of clinical oncology : official journal of the American Society of Clinical Oncology* 2010, **28**(16):2784-2795.
24. Wolff AC, Hammond ME, Hicks DG, Dowsett M, McShane LM, Allison KH, Allred DC, Bartlett JM, Bilous M, Fitzgibbons P *et al*: **Recommendations for human epidermal growth factor receptor 2 testing in breast cancer: American Society of Clinical Oncology/College of American Pathologists clinical practice guideline update.** *Journal of clinical oncology : official journal of the American Society of Clinical Oncology* 2013, **31**(31):3997-4013.
25. !!! INVALID CITATION !!!
26. Natrajan R, Wilkerson PM, Marchiò C, Piscuoglio S, Ng CK, Wai P, Lambros MB, Samartzis EP, Dedes KJ, Frankum J *et al*: **Characterization of the genomic features and expressed fusion genes in micropapillary carcinomas of the breast.** *J Pathol* 2014, **232**(5):553-565.
27. Cheng DT, Mitchell TN, Zehir A, Shah RH, Benayed R, Syed A, Chandramohan R, Liu ZY, Won HH, Scott SN *et al*: **Memorial Sloan Kettering-Integrated Mutation Profiling of Actionable Cancer Targets (MSK-IMPACT): A Hybridization Capture-Based Next-Generation Sequencing Clinical Assay for Solid Tumor Molecular Oncology.** *J Mol Diagn* 2015, **17**(3):251-264.
28. **Comprehensive molecular portraits of human breast tumours.** *Nature* 2012, **490**(7418):61-70.
29. McKenna A, Hanna M, Banks E, Sivachenko A, Cibulskis K, Kernytsky A, Garimella K, Altshuler D, Gabriel S, Daly M *et al*: **The Genome Analysis Toolkit: a MapReduce**

- framework for analyzing next-generation DNA sequencing data. *Genome research* 2010, **20**(9):1297-1303.
30. Cibulskis K, Lawrence MS, Carter SL, Sivachenko A, Jaffe D, Sougnez C, Gabriel S, Meyerson M, Lander ES, Getz G: **Sensitive detection of somatic point mutations in impure and heterogeneous cancer samples.** *Nat Biotechnol* 2013, **31**(3):213-219.
 31. Koboldt DC, Zhang Q, Larson DE, Shen D, McLellan MD, Lin L, Miller CA, Mardis ER, Ding L, Wilson RK: **VarScan 2: somatic mutation and copy number alteration discovery in cancer by exome sequencing.** *Genome research* 2012, **22**(3):568-576.
 32. Saunders CT, Wong WS, Swamy S, Becq J, Murray LJ, Cheetham RK: **Strelka: accurate somatic small-variant calling from sequenced tumor-normal sample pairs.** *Bioinformatics (Oxford, England)* 2012, **28**(14):1811-1817.
 33. Dees ND, Zhang Q, Kandoth C, Wendl MC, Schierding W, Koboldt DC, Mooney TB, Callaway MB, Dooling D, Mardis ER *et al*: **MuSiC: identifying mutational significance in cancer genomes.** *Genome research* 2012, **22**(8):1589-1598.
 34. De Mattos-Arruda L, Weigelt B, Cortes J, Won HH, Ng CK, Nuciforo P, Bidard FC, Aura C, Saura C, Peg V *et al*: **Capturing intra-tumor genetic heterogeneity by de novo mutation profiling of circulating cell-free tumor DNA: a proof-of-principle.** *Ann Oncol* 2014, **25**(9):1729-1735.
 35. Schwarz JM, Rodelsperger C, Schuelke M, Seelow D: **MutationTaster evaluates disease-causing potential of sequence alterations.** *Nature methods* 2010, **7**(8):575-576.
 36. Carter H, Chen S, Isik L, Tyekucheva S, Velculescu VE, Kinzler KW, Vogelstein B, Karchin R: **Cancer-specific high-throughput annotation of somatic mutations: computational prediction of driver missense mutations.** *Cancer Res* 2009, **69**(16):6660-6667.
 37. Shihab HA, Gough J, Cooper DN, Stenson PD, Barker GL, Edwards KJ, Day IN, Gaunt TR: **Predicting the functional, molecular, and phenotypic consequences of amino acid substitutions using hidden Markov models.** *Hum Mutat* 2013, **34**(1):57-65.
 38. Martelotto LG, Ng C, De Filippo MR, Zhang Y, Piscuoglio S, Lim R, Shen R, Norton L, Reis-Filho JS, Weigelt B: **Benchmarking mutation effect prediction algorithms using functionally validated cancer-related missense mutations.** *Genome biology* 2014, **15**(10):484.
 39. Shihab HA, Gough J, Cooper DN, Day IN, Gaunt TR: **Predicting the functional consequences of cancer-associated amino acid substitutions.** *Bioinformatics* 2013, **29**(12):1504-1510.
 40. Kandoth C, McLellan MD, Vandin F, Ye K, Niu B, Lu C, Xie M, Zhang Q, McMichael JF, Wyczalkowski MA *et al*: **Mutational landscape and significance across 12 major cancer types.** *Nature* 2013, **502**(7471):333-339.
 41. Futreal PA, Coin L, Marshall M, Down T, Hubbard T, Wooster R, Rahman N, Stratton MR: **A census of human cancer genes.** *Nat Rev Cancer* 2004, **4**(3):177-183.
 42. Lawrence MS, Stojanov P, Mermel CH, Robinson JT, Garraway LA, Golub TR, Meyerson M, Gabriel SB, Lander ES, Getz G: **Discovery and saturation analysis of cancer genes across 21 tumour types.** *Nature* 2014, **505**(7484):495-501.
 43. Choi Y, Sims GE, Murphy S, Miller JR, Chan AP: **Predicting the functional effect of amino acid substitutions and indels.** *PLoS One* 2012, **7**(10):e46688.
 44. Carter SL, Cibulskis K, Helman E, McKenna A, Shen H, Zack T, Laird PW, Onofrio RC, Winckler W, Weir BA *et al*: **Absolute quantification of somatic DNA alterations in human cancer.** *Nature biotechnology* 2012, **30**(5):413-421.
 45. Landau DA, Carter SL, Stojanov P, McKenna A, Stevenson K, Lawrence MS, Sougnez C, Stewart C, Sivachenko A, Wang L *et al*: **Evolution and impact of subclonal mutations in chronic lymphocytic leukemia.** *Cell* 2013, **152**(4):714-726.

46. Ronglai S, Seshan V: **FACETS: Fraction and Allele-Specific Copy Number Estimates from Tumor Sequencing**. *Memorial Sloan-Kettering Cancer Center, Dept of Epidemiology & Biostatistics Working Paper Series* 2015(Working Paper 29.).
47. Piscuoglio S, Burke KA, Ng CK, Papanastasiou AD, Geyer FC, Macedo GS, Martelotto LG, de Bruijn I, De Filippo MR, Schultheis AM *et al*: **Uterine adenocarcinomas are mesenchymal neoplasms**. *The Journal of pathology* 2016, **238**(3):381-388.
48. Popova T, Manie E, Rieunier G, Caux-Moncoutier V, Tirapo C, Dubois T, Delattre O, Sigal-Zafrani B, Bollet M, Longy M *et al*: **Ploidy and large-scale genomic instability consistently identify basal-like breast carcinomas with BRCA1/2 inactivation**. *Cancer Res* 2012, **72**(21):5454-5462.
49. Curtis C, Shah SP, Chin SF, Turashvili G, Rueda OM, Dunning MJ, Speed D, Lynch AG, Samarajiwa S, Yuan Y *et al*: **The genomic and transcriptomic architecture of 2,000 breast tumours reveals novel subgroups**. *Nature* 2012, **486**(7403):346-352.
50. Ashworth A, Lord CJ, Reis-Filho JS: **Genetic interactions in cancer progression and treatment**. *Cell* 2011, **145**(1):30-38.
51. Turner NC, Reis-Filho JS: **Basal-like breast cancer and the BRCA1 phenotype**. *Oncogene* 2006, **25**(43):5846-5853.
52. Lakhani SR, Reis-Filho JS, Fulford L, Penault-Llorca F, van der Vijver M, Parry S, Bishop T, Benitez J, Rivas C, Bignon YJ *et al*: **Prediction of BRCA1 status in patients with breast cancer using estrogen receptor and basal phenotype**. *Clin Cancer Res* 2005, **11**(14):5175-5180.
53. Hoesly AM, Gorski JJ, Murray MM, Quinn JE, Chung WY, Stewart GE, James CR, Farragher SM, Mulligan JM, Scott AN *et al*: **Molecular basis for estrogen receptor alpha deficiency in BRCA1-linked breast cancer**. *J Natl Cancer Inst* 2007, **99**(22):1683-1694.
54. Gorski JJ, Kennedy RD, Hoesly AM, Harkin DP: **The complex relationship between BRCA1 and ERalpha in hereditary breast cancer**. *Clin Cancer Res* 2009, **15**(5):1514-1518.
55. Lim E, Vaillant F, Wu D, Forrest NC, Pal B, Hart AH, Asselin-Labat ML, Gyorki DE, Ward T, Partanen A *et al*: **Aberrant luminal progenitors as the candidate target population for basal tumor development in BRCA1 mutation carriers**. *Nat Med* 2009, **15**(8):907-913.
56. Molyneux G, Geyer FC, Magnay FA, McCarthy A, Kendrick H, Natrajan R, Mackay A, Grigoriadis A, Tutt A, Ashworth A *et al*: **BRCA1 basal-like breast cancers originate from luminal epithelial progenitors and not from basal stem cells**. *Cell Stem Cell* 2010, **7**(3):403-417.
57. Manié E, Vincent-Salomon A, Lehmann-Che J, Pierron G, Turpin E, Warcoin M, Gruel N, Lebigot I, Sastre-Garau X, Lidereau R *et al*: **High frequency of TP53 mutation in BRCA1 and sporadic basal-like carcinomas but not in BRCA1 luminal breast tumors**. *Cancer Res* 2009, **69**(2):663-671.
58. Evers B, Helleday T, Jonkers J: **Targeting homologous recombination repair defects in cancer**. *Trends Pharmacol Sci* 2010, **31**(8):372-380.
59. Santarosa M, Ashworth A: **Haploinsufficiency for tumour suppressor genes: when you don't need to go all the way**. *Biochim Biophys Acta* 2004, **1654**(2):105-122.
60. Pathania S, Bade S, Le Guillou M, Burke K, Reed R, Bowman-Colin C, Su Y, Ting DT, Polyak K, Richardson AL *et al*: **BRCA1 haploinsufficiency for replication stress suppression in primary cells**. *Nat Commun* 2014, **5**:5496.
61. Ludwig T, Chapman DL, Papaioannou VE, Efstratiadis A: **Targeted mutations of breast cancer susceptibility gene homologs in mice: lethal phenotypes of Brca1, Brca2, Brca1/Brca2, Brca1/p53, and Brca2/p53 nullizygous embryos**. *Genes Dev* 1997, **11**(10):1226-1241.

62. Hakem R, de la Pompa JL, Sirard C, Mo R, Woo M, Hakem A, Wakeham A, Potter J, Reitmair A, Billia F *et al*: **The tumor suppressor gene Brca1 is required for embryonic cellular proliferation in the mouse.** *Cell* 1996, **85**(7):1009-1023.
63. Nik-Zainal S, Davies H, Staaf J, Ramakrishna M, Glodzik D, Zou X, Martincorena I, Alexandrov LB, Martin S, Wedge DC *et al*: **Landscape of somatic mutations in 560 breast cancer whole-genome sequences.** *Nature* 2016.
64. Crook T, Brooks LA, Crossland S, Osin P, Barker KT, Waller J, Philp E, Smith PD, Yulug I, Peto J *et al*: **p53 mutation with frequent novel condons but not a mutator phenotype in BRCA1- and BRCA2-associated breast tumours.** *Oncogene* 1998, **17**(13):1681-1689.

Figure 1.

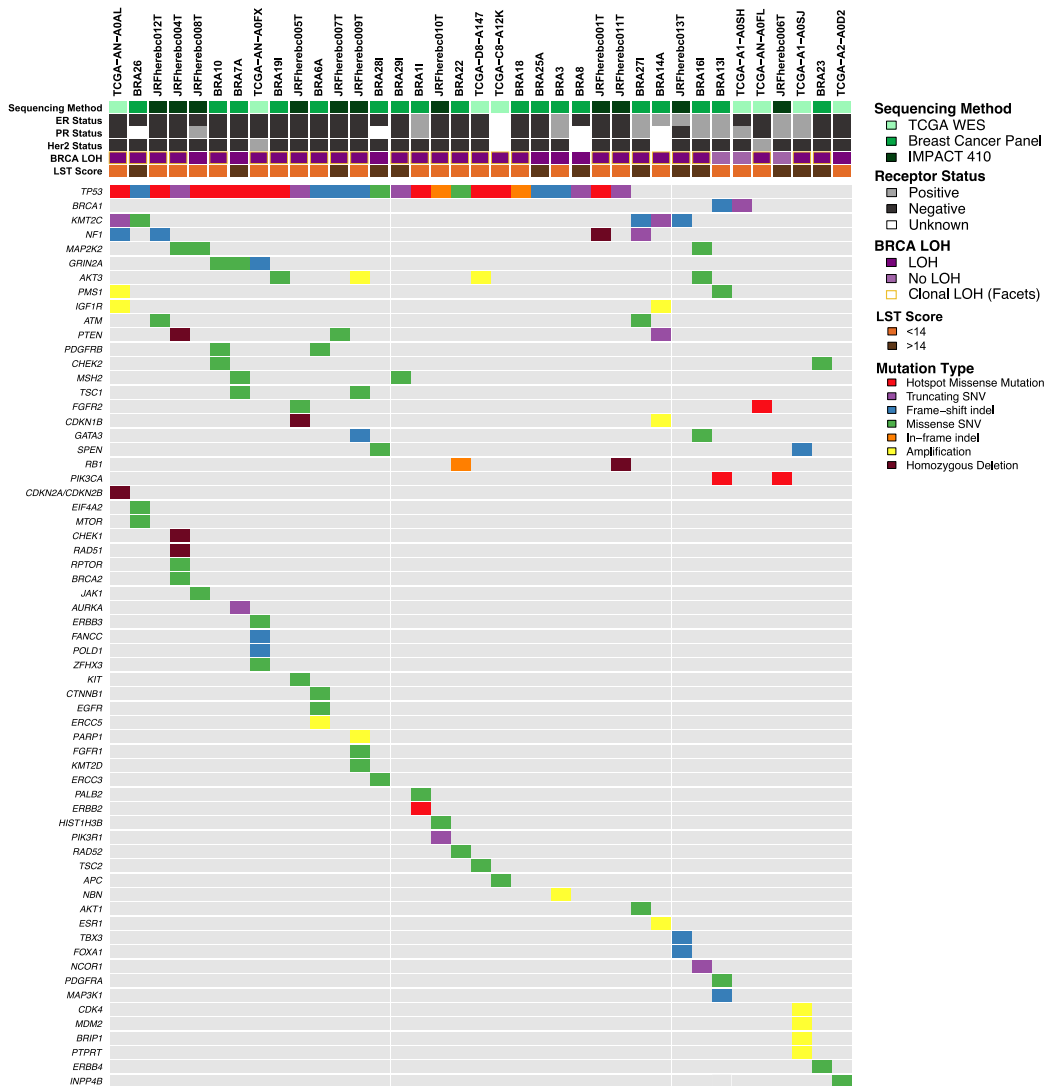

Figure 1. Repertoires of mutations, gene amplifications and homozygous deletions of BRCA1-associated breast tumors. Heatmap indicating the non-synonymous somatic mutations, amplifications and homozygous deletions in the 37 BRCA1 breast tumors analyzed. Each column represents one sample and rows genes. Alteration types are color-coded according to the legend. Diagonal bar was used to represent loss of heterozygosity (LOH) of the wild-type allele of a mutated gene. Only the 227 genes present in the three target capture panels were included. Expression of ER, PR and HER2 as defined by immunohistochemistry, BRCA1 LOH clonality and large-scale state transitions (LST) score are shown on figure.

Figure 2.

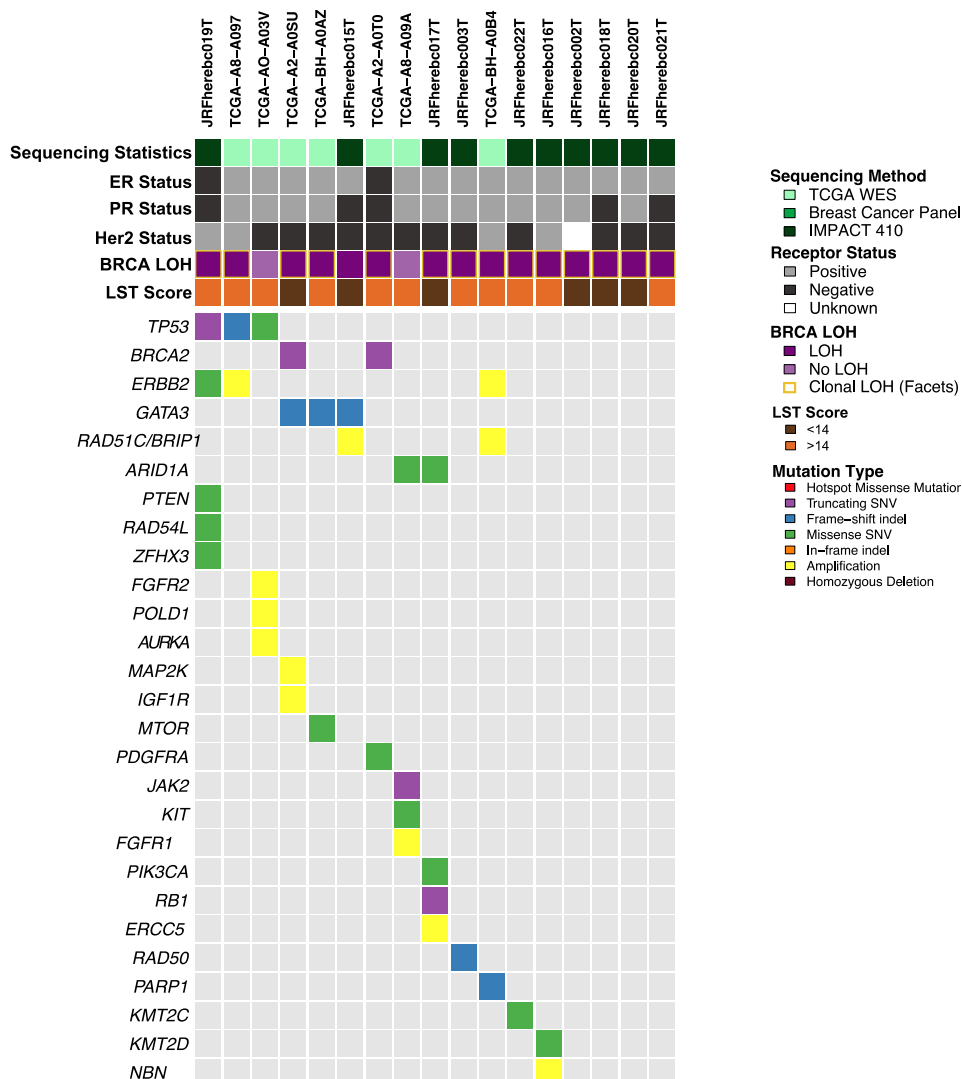

Figure 2. Repertoires of mutations, gene amplifications and homozygous deletions of BRCA2-associated breast tumors. Heatmap indicating the non-synonymous somatic mutations, amplifications and homozygous deletions in the 17 BRCA2 breast tumors analyzed. Each column represents one sample and rows genes. Alteration types are color-coded according to the legend. Diagonal bar was used to represent loss of heterozygosity (LOH) of the wild-type allele of a mutated gene. Only the 227 genes present in the three target capture panels were included. Expression of ER, PR and HER2 as defined by immunohistochemistry, BRCA2 LOH clonality and large-scale state transitions (LST) score.

Figure 3.

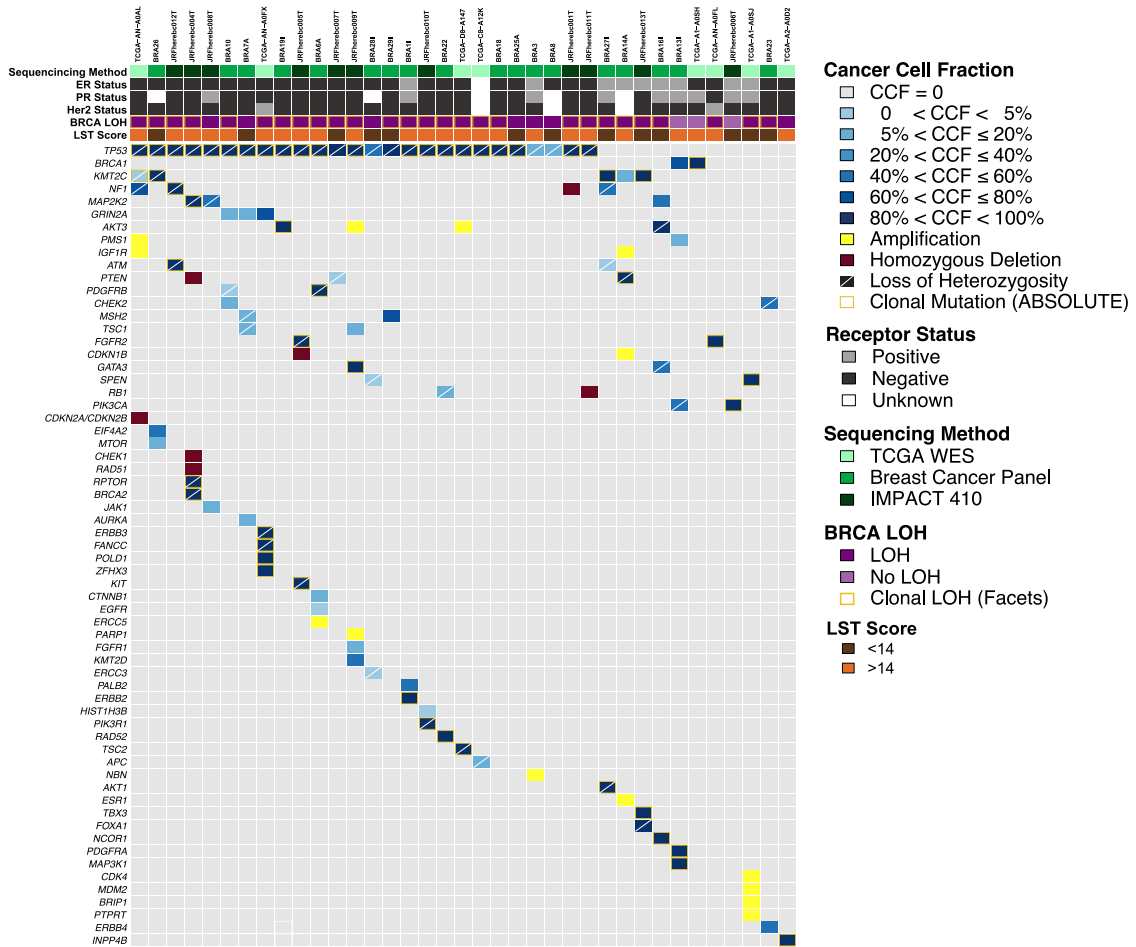

Figure 3. Cancer cell fraction of every non-synonymous mutation found in BRCA1 breast tumors. Integrated analysis of the mutant allele fractions, tumor cell content, ploidy and local copy number using ABSOLUTE was performed to determine the cancer cell fractions (CCFs) of every non-synonymous. CCFs are color-coded according to the legend.

Figure 4.

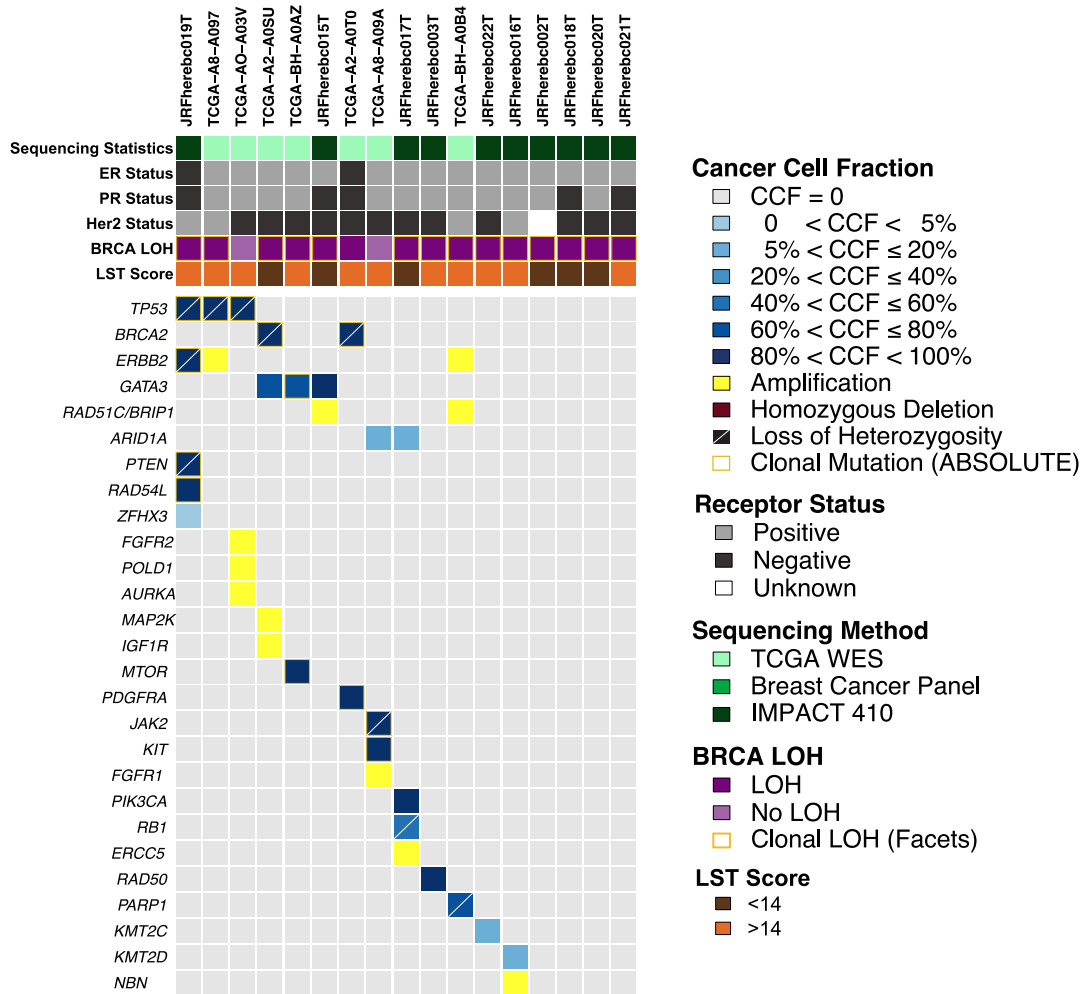
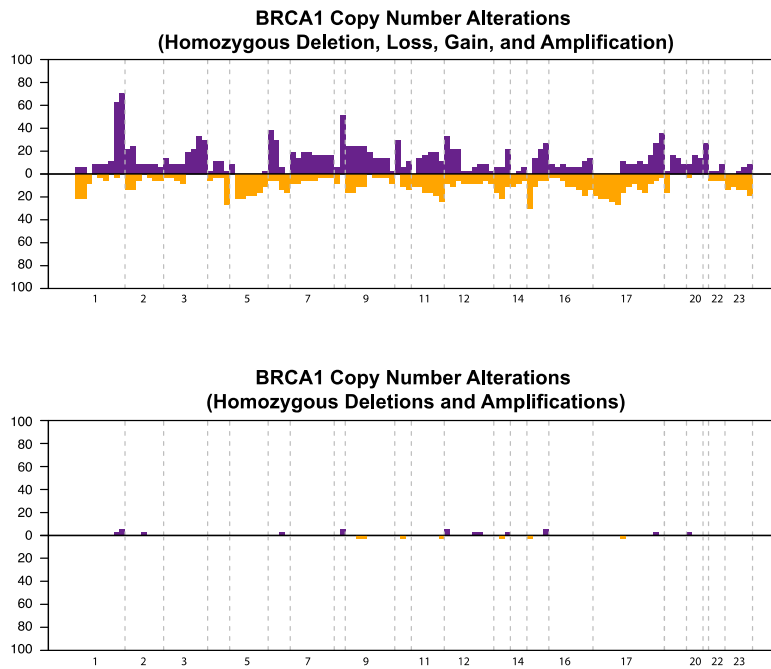

Figure 4. Cancer cell fraction of every non-synonymous mutation found in BRCA2 breast tumors. Integrated analysis of mutant allele fractions, tumor cell content, ploidy and local copy number using ABSOLUTE was performed to determine the cancer cell fractions (CCFs) of every non-synonymous. CCFs are color-coded according to the legend.

Figure 5.

a.



b.

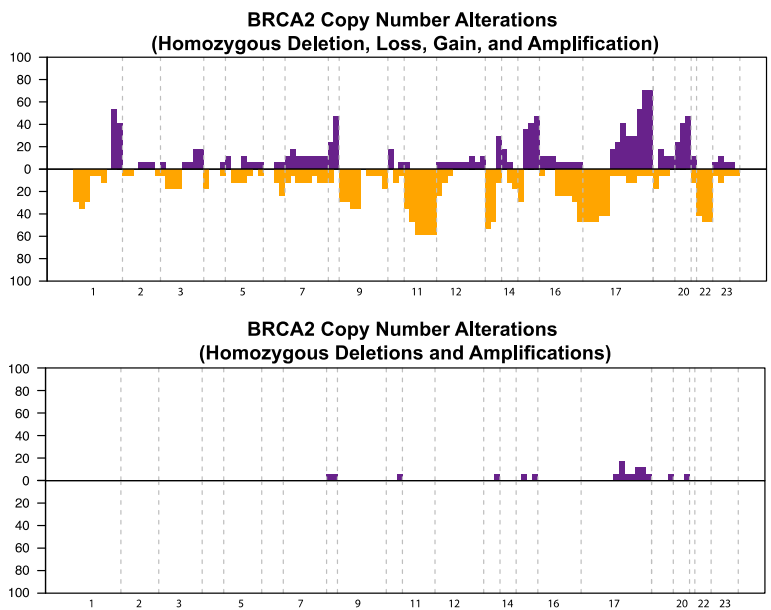

Figure 5. Copy number alterations of BRCA1- and BRCA2-associated breast cancers. (a) Frequency of copy number gains, losses, amplifications and homozygous deletions of 37 BRCA1 and 17 BRCA2 breast tumors subjected to target capture massively parallel sequencing are shown on the top and bottom, respectively.

Para fins didáticos as considerações finais desta tese serão apresentadas separadamente por grupo de objetivo, já que duas diferentes síndromes de predisposição hereditária ao câncer foram estudadas. Além disso, o enfoque dado ao estudo da Síndrome de Li-Fraumeni foi o entendimento das bases moleculares e funcionais associadas a predisposição ao câncer em indivíduos portadores de mutações herdadas no gene *TP53*. Já no estudo do câncer de mama associado aos genes *BRCA1* e *BRCA2*, o objetivo foi caracterizar o conjunto de alterações somáticas, incluindo mutações e variação no número de cópias de DNA, bem como inferir a frequência clonal dos eventos moleculares encontrados nestes tumores.

Achados relacionados a Síndrome de Li-Fraumeni

Nos últimos anos boa parte dos estudos realizados por nosso grupo de pesquisa focaram no entendimento de diferentes aspectos relacionados a SLF/LFL. Parte deste interesse deveu-se, principalmente, a alta prevalência populacional nas regiões Sul e Sudeste do Brasil de uma mutação específica no gene supressor tumoral *TP53*, a R337H (c.1010G>A, p.Arg337His). Contrastando com o observado em outros países, como EUA e Inglaterra, em que a prevalência estimada para mutações germinativas em *TP53* é de 1/10.000-25.000 (Gonzalez et al., 2009; Lalloo et al., 2003), no Brasil um estudo realizado por nosso laboratório (Palmero et al., 2009) e ou outro publicado por um grupo de pesquisa do Paraná (Custódio et al., 2013) encontraram uma prevalência aproximada de 0.3% para a mutação R337H. Estes achados levaram a inúmeras discussões em relação a real patogenicidade desta mutação.

No ano de 2002, DiGiammarino *et al.* conduziram um estudo no intuito de verificar o efeito funcional do alelo R337H. Ao expressar p53-R337H e a forma selvagem de p53 (p53-wt) em células de *Escherichia coli*, os autores observaram que a proteína mutante era estruturalmente muito similar à p53 selvagem, sendo que ambas foram capazes de formar tetrâmeros. No entanto, ao se avaliar a estabilidade destes, observou-se que p53-R337H tornava-se mais instável com o aumento do pH, sendo que aproximadamente 70% dos tetrâmeros encontravam-

se desnaturados em pH 8, enquanto que p53-wt só era desnaturada a temperaturas acima de 50 °C. Também foi demonstrado que uma ponte de sal entre a Arginina do códon 337 e a Asparagina do 352 era formada e que esta ligação seria fundamental para a dimerização e posterior formação do tetrâmero. Desta forma, a presença da mutação R337H, em que a Arginina 337 é substituída por uma Histidina, introduziria diferenças químicas nesta região, levando a uma desestabilização da ponte de sal e desestruturação do tetrâmero em condições de aumento de pH (DiGiammarino et al., 2002). É importante salientar, no entanto, que na época desta publicação o único estudo realizado apontava para uma associação tecido-específica de R337H, em que a mutação predispunha, exclusivamente, ao desenvolvimento de CAC (Ribeiro et al., 2001). Baseado nesta associação específica, DiGiammarino *et al.* (2002) hipotetizaram que devido ao remodelamento sofrido pela glândula adrenal durante o período pré- e pós-natal, em que uma parcela significativa das células adrenais sofrem apoptose associada a aumento do pH intracelular (~7.9), p53-R337H tornava-se disfuncional, interferindo, assim, na indução de apoptose. Apesar de ser o primeiro estudo a sugerir o provável mecanismo de carcinogênese de R337H, algumas limitações devem ser consideradas. Por exemplo, o modelo de carcinogênese proposto explica apenas o desenvolvimento de CAC. Posteriormente a publicação do estudo, inúmeros outros trabalhos verificaram que R337H também estava associada ao desenvolvimento de outros tumores do espectro da SLF/LFL (Achatz et al., 2007; Giacomazzi et al., 2013). Além disso, deve-se levar em consideração o modelo biológico utilizado no trabalho. Todos os experimentos foram realizados após a transfecção de um pequeno segmento do cDNA de *TP53* (códon 311 ao códon 360) em células de *E. Coli*.

Apesar das limitações do nosso estudo funcional apresentado nesta tese (**capítulo V**), em que apenas alguns mecanismos biológicos regulados por p53 foram avaliados em um pequeno número de fibroblastos primários, parte dos nossos resultados corroboram achados prévios já publicados, enquanto outros demonstram alterações até então desconhecidas no contexto da Síndrome de Li-Fraumeni e de R337H. A investigação de parâmetros bioenergéticos e de resposta a estresse genotóxico em fibroblastos de pacientes com diferentes

mutações no gene *TP53* revelou o possível envolvimento de um tipo específico de dano de DNA no processo de instabilidade genética potencialmente relacionado ao desenvolvimento de câncer em Li-Fraumeni. Os altos níveis de EROs produzidos por células de pacientes associados a um aumento substancial no reparo de sítios abásicos sugerem fortemente que, mesmo sob condições fisiológicas (ausência aparente de dano de DNA), a presença de uma mutação patogênica germinativa em *TP53* acarreta em uma deficiência nos mecanismos antioxidantes celulares, o que leva a uma resposta celular constitutiva/crônica de reparo de DNA, especialmente de sítios abásicos. De fato, já é bem difundido na literatura que EROs ao reagirem com o DNA induzem, principalmente, a formação de sítios apurínicos e apirimidínicos (sítios abásicos) (Chastain et al., 2010). Além disso, considerando a bem estabelecida associação entre instabilidade genômica e câncer (Hanahan & Weinberg, 2011), nossos resultados sugerem que o aumento na produção de EROs encontrado nas células de pacientes associado aos altos índices de reparo de sítios abásicos, podem estar diretamente relacionados ao processo de desenvolvimento de tumores em portadores da mutação R337H e, possivelmente, em portadores de mutações localizadas no DLD de p53. Estes achados reforçam a hipótese já levantada por alguns autores de que substâncias antioxidantes podem apresentar um papel importante na profilaxia de câncer em pacientes com SLF/LFL (Wang et al., 2012; Sablina et al., 2005). Deve-se salientar também que apesar de alguns tratamentos inovadores, como Advexin e Metformina (clinicaltrials.gov), estarem em fase de testes clínicos para síndrome, atualmente portadores de mutações em *TP53* são tratados da mesma forma que indivíduos com tumores esporádicos de mesmo tipo.

Um outro tópico apresentado nesta tese e com especial relevância para o diagnóstico molecular da SLF/LFL, refere-se a identificação de uma variante específica na região 3'UTR de *TP53* (rs78378222, A>C) em famílias com critérios clínicos para a síndrome, mas negativas para mutações em regiões codificantes do gene *TP53* (exons 2-11). A variante rs78378222 [C] havia sido descrita inicialmente em 2011, através de um estudo de GWAS (*genome-wide association study*) realizado na população da Islândia, e foi associada a um alto risco de desenvolvimento de carcinoma de células basais da pele (Stacey et al., 2011).

Esse estudo também demonstrou que rs78378222 localizava-se na sequência sinal de poliadenilação de *TP53* (AATAAA > AATACA), sendo que a presença do alelo variante levava a um processamento alterado do transcrito aliado a uma maior instabilidade e degradação deste.

Considerando a funcionalidade da variante rs78378222 [C] e o fato de mutações patogênicas em regiões codificantes do gene *TP53* não serem identificadas em uma parcela significativa das famílias com critérios clínicos para SLF e LFL, decidimos por testar a frequência da variante em diferentes grupos, dentre estes: 1) mulheres com câncer de mama (n=213), pacientes com fenótipo compatível de SLS/LFL 2) positivos (n=130) e 3) negativos (n=129) para mutações patogênicas em regiões codificantes do gene *TP53* e um 4) grupo controle composto por mulheres assintomáticas e previamente testadas para a mutação R337H (n=299). Confirmando nossa hipótese inicial de que o alelo poderia explicar o fenótipo familiar de SLF/LFL em uma parcela dos casos, rs78378222 [C] foi identificada em 5.4%(7/129) dos indivíduos avaliados. Outras achados, como a alta conservação evolutiva do alelo selvagem, os baixos níveis de p53 encontrados em tumores de portadores da variante e em fibroblastos expostos radiação ionizante reforçam a patogenicidade de rs78378222 [C]. Nossos resultados, apesar de necessitarem de validação em outras coortes, reforçam a importância de uma análise molecular mais abrangente do gene *TP53* em indivíduos com suspeita clínica de SLF/LFL e negativos para mutações em regiões codificantes. Recentemente, Dr. Li Yong (University of Louisville, comunicação pessoal) confirmou a patogênese de rs78378222 [C] em modelo animal, visto que camundongos portadores da variante apresentaram alto risco para o desenvolvimento de um amplo espectro de tumores.

O estudo de modificadores de fenótipo na SLF também tem sido alvo de investigação de grupos de pesquisa trabalhando com a doença. A SLF é bem conhecida por sua grande heterogeneidade de manifestações clínicas, que apresentam-se através das seguintes características: penetrância incompleta, ampla variação nas idades ao diagnóstico do primeiro tumor e diagnósticos de tipos tumorais diversos, mesmo entre indivíduos de uma mesma família e portadores de uma mesma mutação (Malkin et al., 2010). Acredita-se que parte

da variação fenotípica encontrada em pacientes com SLF seja devido a atuação de genes modificadores ou a alterações no próprio gene *TP53* (modificadores intragênicos) (Palmero et al., 2010). Neste contexto, um polimorfismo funcional na região promotora do gene *MDM2* (SNP309 T>G) tem sido associado a uma antecipação na idade ao diagnóstico de câncer em portadores de mutações no DLD de *TP53* (Bond et al., 2004; Bougeard et al., 2006). Com um impacto ainda mais marcante na idade de acometimento de câncer está o polimorfismo PIN3 (duplicação de 16 pares de base no intron 3; alelo A1: normal e alelo A2: duplicado) do gene *TP53*. Marcel et al. demonstraram que a presença do alelo duplicado está associada com uma diferença de 19 anos na média de idade do primeiro diagnóstico em portadores de mutações germinativas em *TP53* (A1A1: 28.0 anos; A1A2: 47.0 anos; $p = 0.01$) (Marcel et al., 2011).

Devido a escassez de estudos de modificadores de fenótipo em portadores da mutação R337H e a relevância clínica da identificação de marcadores genéticos que possam auxiliar no manejo dos pacientes especificamente com esta mutação, nosso objetivo foi verificar o impacto dos três mais bem descritos polimorfismos nos principais genes reguladores da atividade de p53, incluindo *MDM2*, *MDM4* e *USP7*, nas manifestações clínicas de portadores da mutação R337H. Nossos achados sugerem que da mesma forma que em portadores de mutações localizadas no DLD de p53, o polimorfismo MDM2 309 também pode estar associado a uma aceleração na idade de diagnóstico de câncer em portadores da mutação R337H. Nossos resultados demonstram que o alelo G (alelo de risco) é significativamente mais frequente em portadores de R337H do que em controles ($p=0.014$). Além disso, ao observarmos as idades médias ao diagnóstico de CAC e CM, observamos que para ambos grupos portadores do genótipo MDM2GG apresentam uma aceleração na idade de início de câncer quando comparado à portadores dos genótipos MDM2TG e MDM2TT. O fato das diferenças não serem estatisticamente significativas deve-se, provavelmente, a grande dispersão dos resultados e o limitado tamanho amostral. De fato, um estudo funcional já demonstrou que a presença do alelo G em *MDM2* intensifica a interação com o fator transcricional Sp1, aumentando assim a expressão de *MDM2* e levando a uma atenuação da atividade de p53 (Knappskog et al., 2011).

Conforme mencionado acima, reprogramação metabólica é descrita como uma das *hallmarks* da carcinogênese (Weinberg 2011). No contexto da SLF, tanto estudos em modelos animais quanto em humanos já demonstraram alterações na regulação bioenergética (Wang et al., 2012; Macedo et al., 2012), bem como o impacto da suplementação com substâncias antioxidantes na prevenção de câncer (Sablina et al., 2005). Em um estudo clássico conduzido por Sablina *et al.* (2005), foi demonstrado que animais knockout ($p53^{-/-}$) suplementados com N-acetilcisteína (NAC) foram completamente protegidos contra o desenvolvimento de linfomas, enquanto que no grupo não-suplementado uma alta incidência deste tumor (90%) foi observada. Confirmando estes achados, Li *et al.* (2012) produziram camundongos com alterações em sítios de acetilação de p53 ($p53^{K117R+K161R+K162R}$) essenciais para a indução de parada do ciclo celular, senescência e apoptose, todos estes mecanismos clássicos de supressão tumoral. De maneira surpreendente, foi observado que as células destes animais preservavam a capacidade de regular metabolismo energético e produção de EROs, o que os tornava ainda protegidos contra linfomas (Li et al., 2012). Estes resultados fizeram com que nós levantássemos a hipótese de que a manutenção da homeostase energética e antioxidante apresentaria, da mesma forma que em modelo animal, um papel central na profilaxia de câncer em portadores de mutações em *TP53*, neste caso de R337H. Apesar do objetivo do nosso estudo não ter sido testar o impacto direto da suplementação com antioxidantes na incidência de tumores, visto que indivíduos suplementados teriam que ser acompanhados por um longo período de tempo, nossos resultados demonstram o impacto de algumas destas substâncias na correção bioquímica de parâmetros de estresse oxidativo.

A primeira substância antioxidante testada neste estudo foi NAC, uma molécula precursora derivada de cisteína e que auxilia na produção de glutathiona, uma importante proteína antioxidante endógena (Sansone et al., 2011). NAC tem sido amplamente utilizada para algumas situações clínicas e foi uma das únicas substâncias testadas até o momento em modelos pré-clínicos da SLF (Sablina et al., 2005). Nossos resultados em relação ao efeito de NAC sobre parâmetros de estresse oxidativo são difíceis de interpretar, visto que seu uso foi capaz de

reduzir o dano oxidativo à proteínas (conteúdo de carbonilas) apenas no grupo controle. Além disso, o grupo placebo também apresentou uma redução deste parâmetro, nos levando a questionar o real impacto desta substância. Carbonilação de proteínas tem sido caracterizada como um tipo de alteração oxidativa irreversível e capaz de induzir perda parcial ou total na função de proteínas (Levine et al. 1990). Já as dosagens de marcadores de oxidação lipídica após o período de suplementação com NAC mostraram um aumento de Malondialdeído (MDA), um molécula gerada pela lipoperoxidação de lipídeos de membrana, exclusivamente no grupo R377H. Desta forma, NAC não parece ter o efeito desejado na diminuição do dano oxidativo em portadores da mutação R337H. De acordo com estes achados, inúmeros estudos já demonstraram a função pró-oxidante de NAC e algumas outras substâncias, tanto *in vitro* quanto em *in vivo* (Lambert et al., 2010; Sayin et al., 2014; Lu et al., 2013).

Já o uso de Coenzima Q10 e sua derivada sintética Idebenona, ambas drogas aprovadas para o uso em doenças neurodegenerativas e conhecidas por seu papel no transporte de elétrons da cadeia respiratória mitocondrial (Gueven et al., 2015), reduziram os níveis de oxidação de lipídios, especialmente no grupo de portadores da mutação R337H. Para ambos métodos de medida da lipoperoxidação lipídica, o uso de Idebenona foi associado a uma diminuição no conteúdo de MDA e de substâncias reativas ao ácido tiobarbitúrico (TBARS). Já Coenzima Q10 produziu efeito significativo apenas no conteúdo de TBARS. De fato, a atividade antioxidante da Coenzima Q10 e Idebenona tem sido demonstrada, principalmente, por seu papel na proteção de membranas lipídicas contra EROs. Além disso, devido ao seu menor peso molecular e maior solubilidade em água, Idebenona parece apresentar maior biodisponibilidade e atividade quando comparada ao Coenzima Q10, explicando assim o melhor efeito desta (Parkinson et al., 2013). Idebenona tem sido utilizada clinicamente para doenças associadas a alterações na cadeia transportadora de elétrons, como neuropatia ótica hereditária de Leber, Síndrome de Leigh, Ataxia de Friedreich e Doença de Huntington (Giorgio et al., 2012). Além disso, estudos de fase 1 demonstraram que esta droga é segura e bem tolerada (Prospero et al., 2007).

Por fim, nossos resultados do perfil de citocinas, quimiocinas e fatores de crescimento apontam para um possível envolvimento inflamatório em portadores da mutação R337H. Apesar de apenas IL-12 diferir significativamente entre casos e controles ($P=0.001$), com maior dosagem em portadores, os valores médios de IL-17, IFN- γ e IL-8 também apresentam-se aumentados em portadores da mutação R337H. Curiosamente, as funções destes sinalizadores imunológicos estão interconectadas. Interleucina 12 é uma citosina secretada por linfócitos B, neutrófilos, células dendríticas e macrófagos após a ativação por células apresentadoras de antígenos. Sua função central é induzir a secreção de IFN- γ por células T auxiliares e *Natural Killers* (NKs), aumentando assim respostas citotóxicas contra tumores e infecções virais (Vecchio et al., 2007). Já IL-17 é produzida por células T ativadas e induz secreção de IL-8, sendo que ambas desempenham funções pró-inflamatórias (Ishiku et al., 2005). Esta é a primeira descrição de alterações imunológicas e atividade inflamatória na SLF/LFL. No entanto, estes resultados precisam ser avaliados com cautela e confirmados em uma série maior de casos e em portadores de outras mutações em *TP53*. Além disso, estudos *in vitro* e *in vivo* são necessários para a elucidação do impacto da inflamação na tumorigênese destes pacientes.

Achados relacionados ao câncer de mama associado aos genes *BRCA1* e *BRCA2*

O surgimento de alguns consórcios internacionais como o *The Cancer Genome Atlas* (TCGA) e o *International Cancer Genome Consortium* (ICGC) permitiram avanços importantes no entendimento das bases moleculares dos tumores mais incidentes em humanos. Como um exemplo destes avanços está o câncer de mama, que tem sido foco de inúmeros estudos genômicos. Estes estudos permitiram a identificação das principais alterações somáticas destas neoplasias, a classificação em subtipos moleculares, definição de potenciais alvos terapêuticos e a caracterização do grau e extensão da heterogeneidade intratumoral. Apesar dos inúmeros avanços recentes no entendimento desta neoplasia, os aspectos descritos acima foram pouco explorados naqueles tumores de histologia rara ou ligados a mutações germinativas em genes de predisposição ao CM.

No presente estudo foram sequenciados 39 tumores de mama, sendo 29 de pacientes portadores de mutações germinativas no gene *BRCA1* e 10 de pacientes com mutações em *BRCA2*. Também foram incluídas na análise 15 amostras provenientes do banco de dados público do TCGA, sendo 8 delas de casos de CM associados à *BRCA1* e 7 relacionados à *BRCA2*. Nossos resultados demonstram que *TP53* é o gene mais frequentemente mutado nestes tumores, com uma frequência de mutação de 70% e 18% em casos associados a *BRCA1* e *BRCA2*, respectivamente. Apesar da frequência de mutações em *TP53* de tumores relacionados à *BRCA1* já ter sido previamente reportada por alguns estudos (Crook, et al. 1997; Network 2012; Network 2011), nenhum trabalho havia mostrado a frequência clonal destas alterações. Nossos resultados mostram que mutações em *TP53* são eventos clonais (presentes em 100% das células tumorais) e precoces na carcinogênese destes tumores e, provavelmente, favorecem o acúmulo de novas alterações somáticas e instabilidade genômica. Curiosamente, apenas uma minoria das neoplasias da mama associadas a *BRCA2* desenvolvem-se na presença destas mutações, visto que apenas três tumores apresentaram *TP53* mutado. Além disso, do ponto de vista da análise de marcadores imunohistoquímicos e genéticos, uma grande variabilidade foi encontrada nestes tumores, salientando a grande heterogeneidade genética destas neoplasias. Estudos histopatológicos já reportaram a ampla variabilidade no perfil histológico e na expressão de receptores hormonais e HER2 destes tumores (Melchor et al. 2008). Por fim, a ampla variabilidade do perfil genômico destes cânceres é surpreendente, visto que tem sido postulado que a ordem das alterações genéticas em câncer determina o acúmulo subsequente de mutações durante a progressão tumoral (Ashworth et al., 2011).

Outro achado interessante neste estudo refere-se ao fato da perda somática do alelo selvagem de *BRCA1* e *BRCA2* não ser um evento comum a todos os tumores. Além disso, para alguns casos este pode ser um evento tardio (subclonal) na carcinogênese. Este resultado é de fundamental relevância clínica, visto que a efetividade do tratamento com inibidores de PARP é condicionada pela completa deficiência do processo de RH, que instala-se a partir da perda dos dois alelos de *BRCA1* ou *BRCA2*. Desta forma, acreditamos que aqueles tumores

que preservam o alelo selvagem de *BRCA*, ou perdem o alelo de forma subclonal, podem não se beneficiar do tratamento com inibidores de PARP, sendo este um mecanismo potencial de resistência ao tratamento. Um estudo utilizando *single cell sequencing*, método considerado padrão ouro para a investigação de heterogeneidade intratumoral, encontra-se em andamento e será crucial para a definição da ordem cronológica dos eventos moleculares presentes nos tumores de mama associados aos genes *BRCA1* e *BRCA2*.

Referências bibliográficas

- Achatz, M. I., M. Olivier, F. Le Calvez, G. Martel-Planche, A. Lopes, B. M. Rossi, P. Ashton-Prolla, R. Giugliani, E. I. Palmero, F. R. Vargas, J. C. Da Rocha, A. L. Vettore, and P. Hainaut, 2007, The TP53 mutation, R337H, is associated with Li-Fraumeni and Li-Fraumeni-like syndromes in Brazilian families.: *Cancer Lett*, v. 245, p. 96-102.
- Alpert, T. E., and B. G. Haffty, 2004, Conservative management of breast cancer in BRCA1/2 mutation carriers.: *Clin Breast Cancer*, v. 5, p. 37-42.
- Ashworth, A., 2008, A synthetic lethal therapeutic approach: poly(ADP) ribose polymerase inhibitors for the treatment of cancers deficient in DNA double-strand break repair: *J Clin Oncol*, v. 26, p. 3785-90.
- Ashworth, A., C. J. Lord, and J. S. Reis-Filho, 2011, Genetic interactions in cancer progression and treatment: *Cell*, v. 145, p. 30-8.
- Aylon, Y., and M. Oren, 2011, p53: guardian of ploidy: *Mol Oncol*, v. 5, p. 315-23.
- Birch, J. M., 1994, Familial cancer syndromes and clusters.: *Br Med Bull*, v. 50, p. 624-39.
- Birch, J. M., V. Blair, A. M. Kelsey, D. G. Evans, M. Harris, K. J. Tricker, and J. M. Varley, 1998, Cancer phenotype correlates with constitutional TP53 genotype in families with the Li-Fraumeni syndrome.: *Oncogene*, v. 17, p. 1061-8.
- Bougeard, G., L. Brugières, A. Chompret, P. Gesta, F. Charbonnier, A. Valent, C. Martin, G. Raux, J. Feunteun, B. Bressac-de Paillerets, and T. Frébourg, 2003, Screening for TP53 rearrangements in families with the Li-Fraumeni syndrome reveals a complete deletion of the TP53 gene: *Oncogene*, v. 22, p. 840-6.
- Boyle, J. M., E. L. Mitchell, M. J. Greaves, S. A. Roberts, K. Tricker, E. Burt, J. M. Varley, J. M. Birch, and D. Scott, 1998, Chromosome instability is a predominant trait of fibroblasts from Li-Fraumeni families: *Br J Cancer*, v. 77, p. 2181-92.
- Brose, M. S., T. R. Rebbeck, K. A. Calzone, J. E. Stopfer, K. L. Nathanson, and B. L. Weber, 2002, Cancer risk estimates for BRCA1 mutation carriers identified in a risk evaluation program: *J Natl Cancer Inst*, v. 94, p. 1365-72.
- Brosh, R., and V. Rotter, 2009, When mutants gain new powers: news from the mutant p53 field: *Nat Rev Cancer*, v. 9, p. 701-13.
- Bryant, H. E., N. Schultz, H. D. Thomas, K. M. Parker, D. Flower, E. Lopez, S. Kyle, M. Meuth, N. J. Curtin, and T. Helleday, 2005, Specific killing of BRCA2-deficient tumours with inhibitors of poly(ADP-ribose) polymerase: *Nature*, v. 434, p. 913-7.
- Budanov, A. V., A. A. Sablina, E. Feinstein, E. V. Koonin, and P. M. Chumakov, 2004, Regeneration of peroxiredoxins by p53-regulated sestrins, homologs of bacterial AhpD.: *Science*, v. 304, p. 596-600.
- Bullock, A. N., and A. R. Fersht, 2001, Rescuing the function of mutant p53: *Nat Rev Cancer*, v. 1, p. 68-76.
- Castéra, L., S. Krieger, A. Rousselin, A. Legros, J. J. Baumann, O. Bruet, B. Brault, R. Fouillet, N. Goardon, O. Letac, S. Baert-Desurmont, J. Tinat, O. Bera, C. Dugast, P. Berthet, F. Polycarpe, V. Layet, A. Hardouin, T. Frébourg, and D. Vaur, 2014, Next-generation sequencing for the diagnosis

- of hereditary breast and ovarian cancer using genomic capture targeting multiple candidate genes: *Eur J Hum Genet*, v. 22, p. 1305-13.
- Cosme-Blanco, W., M. F. Shen, A. J. Lazar, S. Pathak, G. Lozano, A. S. Multani, and S. Chang, 2007, Telomere dysfunction suppresses spontaneous tumorigenesis in vivo by initiating p53-dependent cellular senescence: *EMBO Rep*, v. 8, p. 497-503.
- Crook, T., S. Crossland, M. R. Crompton, P. Osin, and B. A. Gusterson, 1997, p53 mutations in BRCA1-associated familial breast cancer: *Lancet*, v. 350, p. 638-9.
- Custódio, G., G. A. Parise, N. Kiesel Filho, H. Komechen, C. C. Sabbaga, R. Rosati, L. Grisa, I. Z. Parise, M. A. Pianovski, C. M. Fiori, J. A. Ledesma, J. R. Barbosa, F. R. Figueiredo, E. R. Sade, H. Ibañez, S. B. Arram, S. T. Stinghen, L. R. Mengarelli, M. M. Figueiredo, D. C. Carvalho, S. G. Avilla, T. D. Woiski, L. C. Poncio, G. F. Lima, R. Pontarolo, E. Lalli, Y. Zhou, G. P. Zambetti, R. C. Ribeiro, and B. C. Figueiredo, 2013, Impact of neonatal screening and surveillance for the TP53 R337H mutation on early detection of childhood adrenocortical tumors: *J Clin Oncol*, v. 31, p. 2619-26.
- DeBerardinis, R. J., J. J. Lum, G. Hatzivassiliou, and C. B. Thompson, 2008, The biology of cancer: metabolic reprogramming fuels cell growth and proliferation: *Cell Metab*, v. 7, p. 11-20.
- Dedes, K. J., P. M. Wilkerson, D. Wetterskog, B. Weigelt, A. Ashworth, and J. S. Reis-Filho, 2011, Synthetic lethality of PARP inhibition in cancers lacking BRCA1 and BRCA2 mutations: *Cell Cycle*, v. 10, p. 1192-9.
- Deng, Y., S. S. Chan, and S. Chang, 2008, Telomere dysfunction and tumour suppression: the senescence connection: *Nat Rev Cancer*, v. 8, p. 450-8.
- DiGiammarino, E. L., A. S. Lee, C. Cadwell, W. Zhang, B. Bothner, R. C. Ribeiro, G. Zambetti, and R. W. Kriwacki, 2002, A novel mechanism of tumorigenesis involving pH-dependent destabilization of a mutant p53 tetramer.: *Nat Struct Biol*, v. 9, p. 12-6.
- Domchek, S. M., J. Tang, J. Stopfer, D. R. Lilli, N. Hamel, M. Tischkowitz, A. N. Monteiro, T. E. Messick, J. Powers, A. Yonker, F. J. Couch, D. E. Goldgar, H. R. Davidson, K. L. Nathanson, W. D. Foulkes, and R. A. Greenberg, 2013, Biallelic deleterious BRCA1 mutations in a woman with early-onset ovarian cancer: *Cancer Discov*, v. 3, p. 399-405.
- Easton, D. F., D. Ford, and D. T. Bishop, 1995, Breast and ovarian cancer incidence in BRCA1-mutation carriers. Breast Cancer Linkage Consortium: *Am J Hum Genet*, v. 56, p. 265-71.
- Eeles, R. A., 1995, Germline mutations in the TP53 gene.: *Cancer Surv*, v. 25, p. 101-24.
- Evers, B., T. Helleday, and J. Jonkers, 2010, Targeting homologous recombination repair defects in cancer: *Trends Pharmacol Sci*, v. 31, p. 372-80.
- Farmer, H., N. McCabe, C. J. Lord, A. N. Tutt, D. A. Johnson, T. B. Richardson, M. Santarosa, K. J. Dillon, I. Hickson, C. Knights, N. M. Martin, S. P. Jackson, G. C. Smith, and A. Ashworth, 2005, Targeting the DNA repair defect in BRCA mutant cells as a therapeutic strategy: *Nature*, v. 434, p. 917-21.
- Feng, Z., H. Zhang, A. J. Levine, and S. Jin, 2005, The coordinate regulation of the p53 and mTOR pathways in cells: *Proc Natl Acad Sci U S A*, v. 102, p. 8204-9.

- Ferlay, J., I. Soerjomataram, R. Dikshit, S. Eser, C. Mathers, M. Rebelo, D. M. Parkin, D. Forman, and F. Bray, 2015, Cancer incidence and mortality worldwide: sources, methods and major patterns in GLOBOCAN 2012: *Int J Cancer*, v. 136, p. E359-86.
- Ferrone, C. R., D. A. Levine, L. H. Tang, P. J. Allen, W. Jarnagin, M. F. Brennan, K. Offit, and M. E. Robson, 2009, BRCA germline mutations in Jewish patients with pancreatic adenocarcinoma: *J Clin Oncol*, v. 27, p. 433-8.
- Figueiredo, B. C., R. Sandrini, G. P. Zambetti, R. M. Pereira, C. Cheng, W. Liu, L. Lacerda, M. A. Pianovski, E. Michalkiewicz, J. Jenkins, C. Rodriguez-Galindo, M. J. Mastellaro, S. Vianna, F. Watanabe, F. Sandrini, S. B. Arram, P. Boffetta, and R. C. Ribeiro, 2006, Penetrance of adrenocortical tumours associated with the germline TP53 R337H mutation.: *J Med Genet*, v. 43, p. 91-6.
- Finch, A., M. Beiner, J. Lubinski, H. T. Lynch, P. Moller, B. Rosen, J. Murphy, P. Ghadirian, E. Friedman, W. D. Foulkes, C. Kim-Sing, T. Wagner, N. Tung, F. Couch, D. Stoppa-Lyonnet, P. Ainsworth, M. Daly, B. Pasini, R. Gershoni-Baruch, C. Eng, O. I. Olopade, J. McLennan, B. Karlan, J. Weitzel, P. Sun, S. A. Narod, and H. O. C. C. S. Group, 2006, Salpingo-oophorectomy and the risk of ovarian, fallopian tube, and peritoneal cancers in women with a BRCA1 or BRCA2 Mutation: *JAMA*, v. 296, p. 185-92.
- Fitarelli-Kiehl, M., J. Giacomazzi, P. Santos-Silva, M. S. Graudenz, E. I. Palmero, R. A. Michelli, M. I. Achatz, C. A. de Toledo Osório, V. E. de Faria Ferraz, C. G. Picanço, and P. Ashton-Prolla, 2015, The breast cancer immunophenotype of TP53-p.R337H carriers is different from that observed among other pathogenic TP53 mutation carriers: *Fam Cancer*, v. 14, p. 333-6.
- Ford, D., D. F. Easton, and J. Peto, 1995, Estimates of the gene frequency of BRCA1 and its contribution to breast and ovarian cancer incidence: *Am J Hum Genet*, v. 57, p. 1457-62.
- Frebourg, T., A. Abel, C. Bonaiti-Pellie, L. Brugières, P. Berthet, B. Bressac-de Paillerets, A. Chevrier, A. Chompret, O. Cohen-Haguenuer, O. Delattre, J. Feingold, J. Feunteun, D. Frappaz, J. P. Fricker, P. Gesta, P. Jonveaux, C. Kalifa, C. Lasset, B. Leheup, J. M. Limacher, M. Longy, C. Nogues, D. Oppenheim, D. Sommelet, F. Soubrier, C. Stoll, D. Stoppa-Lyonnet, and H. Tristant, 2001, [Li-Fraumeni syndrome: update, new data and guidelines for clinical management]. *Bull Cancer*, v. 88, p. 581-7.
- Fung, Y. K., A. L. Murphree, A. T'Ang, J. Qian, S. H. Hinrichs, and W. F. Benedict, 1987, Structural evidence for the authenticity of the human retinoblastoma gene: *Science*, v. 236, p. 1657-61.
- Gatz, S. A., and L. Wiesmüller, 2006, p53 in recombination and repair: *Cell Death Differ*, v. 13, p. 1003-16.
- Giacomazzi, J., M. S. Graudenz, C. A. Osorio, P. Koehler-Santos, E. I. Palmero, M. Zagonel-Oliveira, R. A. Michelli, C. Scapulatempo Neto, G. C. Fernandes, M. I. Achatz, G. Martel-Planche, F. A. Soares, M. Caleffi, J. R. Goldim, P. Hainaut, S. A. Carey, and P. Ashton-Prolla, 2014, Prevalence of the TP53 p.R337H mutation in breast cancer patients in Brazil: *PLoS One*, v. 9, p. e99893.

- Gorski, J. J., R. D. Kennedy, A. M. Hosey, and D. P. Harkin, 2009, The complex relationship between BRCA1 and ERalpha in hereditary breast cancer: *Clin Cancer Res*, v. 15, p. 1514-8.
- Hainaut, P., and M. Hollstein, 2000, p53 and human cancer: the first ten thousand mutations: *Adv Cancer Res*, v. 77, p. 81-137.
- Hanahan, D., and R. A. Weinberg, 2011, Hallmarks of cancer: the next generation: *Cell*, v. 144, p. 646-74.
- Hartley, A. L., J. M. Birch, A. M. Kelsey, H. B. Marsden, M. Harris, and M. D. Teare, 1989, Are germ cell tumors part of the Li-Fraumeni cancer family syndrome?: *Cancer Genet Cytogenet*, v. 42, p. 221-6.
- Hartmann, L. C., D. J. Schaid, J. E. Woods, T. P. Crotty, J. L. Myers, P. G. Arnold, P. M. Petty, T. A. Sellers, J. L. Johnson, S. K. McDonnell, M. H. Frost, and R. B. Jenkins, 1999, Efficacy of bilateral prophylactic mastectomy in women with a family history of breast cancer.: *N Engl J Med*, v. 340, p. 77-84.
- Heymann, S., S. Delalogue, A. Rahal, O. Caron, T. Frebourg, L. Barreau, C. Pachet, M. C. Mathieu, H. Marsiglia, and C. Bourcier, 2010, Radio-induced malignancies after breast cancer postoperative radiotherapy in patients with Li-Fraumeni syndrome: *Radiat Oncol*, v. 5, p. 104.
- Hodgson, S., 2008, Mechanisms of inherited cancer susceptibility: *J Zhejiang Univ Sci B*, v. 9, p. 1-4.
- Hollstein, M., and P. Hainaut, 2010, Massively regulated genes: the example of TP53: *J Pathol*, v. 220, p. 164-73.
- Hollstein, M., D. Sidransky, B. Vogelstein, and C. C. Harris, 1991, p53 mutations in human cancers.: *Science*, v. 253, p. 49-53.
- Honrado, E., A. Osorio, J. Palacios, and J. Benitez, 2006, Pathology and gene expression of hereditary breast tumors associated with BRCA1, BRCA2 and CHEK2 gene mutations: *Oncogene*, v. 25, p. 5837-45.
- Horn, H. F., and K. H. Vousden, 2007, Coping with stress: multiple ways to activate p53: *Oncogene*, v. 26, p. 1306-16.
- Howlett, N. G., T. Taniguchi, S. Olson, B. Cox, Q. Waisfisz, C. De Die-Smulders, N. Persky, M. Grompe, H. Joenje, G. Pals, H. Ikeda, E. A. Fox, and A. D. D'Andrea, 2002, Biallelic inactivation of BRCA2 in Fanconi anemia: *Science*, v. 297, p. 606-9.
- Hussain, S. P., P. Amstad, P. He, A. Robles, S. Lupold, I. Kaneko, M. Ichimiya, S. Sengupta, L. Mechanic, S. Okamura, L. J. Hofseth, M. Moake, M. Nagashima, K. S. Forrester, and C. C. Harris, 2004, p53-induced up-regulation of MnSOD and GPx but not catalase increases oxidative stress and apoptosis.: *Cancer Res*, v. 64, p. 2350-6.
- Jones, R. G., and C. B. Thompson, 2009, Tumor suppressors and cell metabolism: a recipe for cancer growth: *Genes Dev*, v. 23, p. 537-48.
- Kandoth, C., M. D. McLellan, F. Vandin, K. Ye, B. Niu, C. Lu, M. Xie, Q. Zhang, J. F. McMichael, M. A. Wyczalkowski, M. D. Leiserson, C. A. Miller, J. S. Welch, M. J. Walter, M. C. Wendl, T. J. Ley, R. K. Wilson, B. J. Raphael, and L. Ding, 2013, Mutational landscape and significance across 12 major cancer types: *Nature*, v. 502, p. 333-9.
- Kato, S., S. Y. Han, W. Liu, K. Otsuka, H. Shibata, R. Kanamaru, and C. Ishioka, 2003, Understanding the function-structure and function-mutation

- relationships of p53 tumor suppressor protein by high-resolution missense mutation analysis: *Proc Natl Acad Sci U S A*, v. 100, p. 8424-9.
- Kitayner, M., H. Rozenberg, N. Kessler, D. Rabinovich, L. Shaulov, T. E. Haran, and Z. Shakked, 2006, Structural basis of DNA recognition by p53 tetramers: *Mol Cell*, v. 22, p. 741-53.
- Knudson, A. G., 1971, Mutation and cancer: statistical study of retinoblastoma: *Proc Natl Acad Sci U S A*, v. 68, p. 820-3.
- Lane, D. P., and L. V. Crawford, 1979, T antigen is bound to a host protein in SV40-transformed cells: *Nature*, v. 278, p. 261-3.
- Lavigne, A., V. Maltby, D. Mock, J. Rossant, T. Pawson, and A. Bernstein, 1989, High incidence of lung, bone, and lymphoid tumors in transgenic mice overexpressing mutant alleles of the p53 oncogene: *Mol Cell Biol*, v. 9, p. 3982-91.
- Leal, J. F., J. Fominaya, A. Cascón, M. V. Guijarro, C. Blanco-Aparicio, M. Leonart, M. E. Castro, S. Ramon Y Cajal, M. Robledo, D. H. Beach, and A. Carnero, 2008, Cellular senescence bypass screen identifies new putative tumor suppressor genes: *Oncogene*, v. 27, p. 1961-70.
- Levine, A. J., 1997a, p53, the cellular gatekeeper for growth and division: *Cell*, v. 88, p. 323-31.
- Levine, A. J., 1997b, p53, the cellular gatekeeper for growth and division.: *Cell*, v. 88, p. 323-31.
- Levy-Lahad, E., and E. Friedman, 2007, Cancer risks among BRCA1 and BRCA2 mutation carriers: *Br J Cancer*, v. 96, p. 11-5.
- Li, F. P., and J. F. Fraumeni, 1969a, Rhabdomyosarcoma in children: epidemiologic study and identification of a familial cancer syndrome.: *J Natl Cancer Inst*, v. 43, p. 1365-73.
- Li, F. P., and J. F. Fraumeni, 1969b, Soft-tissue sarcomas, breast cancer, and other neoplasms. A familial syndrome?: *Ann Intern Med*, v. 71, p. 747-52.
- Li, F. P., and J. F. Fraumeni, 1982, Prospective study of a family cancer syndrome.: *JAMA*, v. 247, p. 2692-4.
- Limacher, J. M., T. Frebourg, S. Natarajan-Ame, and J. P. Bergerat, 2001, Two metachronous tumors in the radiotherapy fields of a patient with Li-Fraumeni syndrome: *Int J Cancer*, v. 96, p. 238-42.
- Lindor, N. M., M. L. McMaster, C. J. Lindor, M. H. Greene, and D. o. C. P. National Cancer Institute, Community Oncology and Prevention Trials Research Group, 2008, Concise handbook of familial cancer susceptibility syndromes - second edition: *J Natl Cancer Inst Monogr*, p. 1-93.
- Linzer, D. I., and A. J. Levine, 1979, Characterization of a 54K dalton cellular SV40 tumor antigen present in SV40-transformed cells and uninfected embryonal carcinoma cells: *Cell*, v. 17, p. 43-52.
- Lynch, B. J., J. A. Holden, S. S. Buys, S. L. Neuhausen, and D. K. Gaffney, 1998, Pathobiologic characteristics of hereditary breast cancer: *Hum Pathol*, v. 29, p. 1140-4.
- Macedo, G. S., L. Lisboa da Motta, J. Giacomazzi, C. B. Netto, V. Manfredini, C. S. Vanzin, C. R. Vargas, P. Hainaut, F. Klamt, and P. Ashton-Prolla, 2012, Increased oxidative damage in carriers of the germline TP53 p.R337H mutation: *PLoS One*, v. 7, p. e47010.

- Malkin, D., F. P. Li, L. C. Strong, J. F. Fraumeni, C. E. Nelson, D. H. Kim, J. Kassel, M. A. Gryka, F. Z. Bischoff, and M. A. Tainsky, 1990, Germ line p53 mutations in a familial syndrome of breast cancer, sarcomas, and other neoplasms.: *Science*, v. 250, p. 1233-8.
- Manolio, T. A., F. S. Collins, N. J. Cox, D. B. Goldstein, L. A. Hindorff, D. J. Hunter, M. I. McCarthy, E. M. Ramos, L. R. Cardon, A. Chakravarti, J. H. Cho, A. E. Guttmacher, A. Kong, L. Kruglyak, E. Mardis, C. N. Rotimi, M. Slatkin, D. Valle, A. S. Whittemore, M. Boehnke, A. G. Clark, E. E. Eichler, G. Gibson, J. L. Haines, T. F. Mackay, S. A. McCarroll, and P. M. Visscher, 2009, Finding the missing heritability of complex diseases: *Nature*, v. 461, p. 747-53.
- Martins, F. C., S. De, V. Almendro, M. Gönen, S. Y. Park, J. L. Blum, W. Herlihy, G. Ethington, S. J. Schnitt, N. Tung, J. E. Garber, K. Fetten, F. Michor, and K. Polyak, 2012, Evolutionary pathways in BRCA1-associated breast tumors: *Cancer Discov*, v. 2, p. 503-11.
- Masciari, S., A. Dewanwala, E. M. Stoffel, G. Y. Lauwers, H. Zheng, M. I. Achatz, D. Riegert-Johnson, L. Foretova, E. M. Silva, L. Digianni, S. J. Verselis, K. Schneider, F. P. Li, J. Fraumeni, J. E. Garber, and S. Syngal, 2011, Gastric cancer in individuals with Li-Fraumeni syndrome: *Genet Med*, v. 13, p. 651-7.
- Mavaddat, N., D. Barrowdale, I. L. Andrulis, S. M. Domchek, D. Eccles, H. Nevanlinna, S. J. Ramus, A. Spurdle, M. Robson, M. Sherman, A. M. Mulligan, F. J. Couch, C. Engel, L. McGuffog, S. Healey, O. M. Sinilnikova, M. C. Southey, M. B. Terry, D. Goldgar, F. O'Malley, E. M. John, R. Janavicius, L. Tihomirova, T. V. Hansen, F. C. Nielsen, A. Osorio, A. Stavropoulou, J. Benítez, S. Manoukian, B. Peissel, M. Barile, S. Volorio, B. Pasini, R. Dolcetti, A. L. Putignano, L. Ottini, P. Radice, U. Hamann, M. U. Rashid, F. B. Hogervorst, M. Kriege, R. B. van der Luijt, S. Peock, D. Frost, D. G. Evans, C. Brewer, L. Walker, M. T. Rogers, L. E. Side, C. Houghton, J. Weaver, A. K. Godwin, R. K. Schmutzler, B. Wappenschmidt, A. Meindl, K. Kast, N. Arnold, D. Niederacher, C. Sutter, H. Deissler, D. Gadzicki, S. Preisler-Adams, R. Varon-Mateeva, I. Schönbuchner, H. Gevensleben, D. Stoppa-Lyonnet, M. Belotti, L. Barjhoux, C. Isaacs, B. N. Peshkin, T. Caldes, M. de la Hoya, C. Cañadas, T. Heikkinen, P. Heikkilä, K. Aittomäki, I. Blanco, C. Lazaro, J. Brunet, B. A. Agnarsson, A. Arason, R. B. Barkardottir, M. Dumont, J. Simard, M. Montagna, S. Agata, E. D'Andrea, M. Yan, S. Fox, T. R. Rebbeck, W. Rubinstein, N. Tung, J. E. Garber, X. Wang, Z. Fredericksen, V. S. Pankratz, N. M. Lindor, C. Szabo, K. Offit, R. Sakr, et al., 2012, Pathology of breast and ovarian cancers among BRCA1 and BRCA2 mutation carriers: results from the Consortium of Investigators of Modifiers of BRCA1/2 (CIMBA): *Cancer Epidemiol Biomarkers Prev*, v. 21, p. 134-47.
- Maxwell, K. N., and S. M. Domchek, 2012, Cancer treatment according to BRCA1 and BRCA2 mutations: *Nat Rev Clin Oncol*, v. 9, p. 520-8.
- Miki, Y., J. Swensen, D. Shattuck-Eidens, P. A. Futreal, K. Harshman, S. Tavtigian, Q. Liu, C. Cochran, L. M. Bennett, and W. Ding, 1994, A strong candidate for the breast and ovarian cancer susceptibility gene BRCA1: *Science*, v. 266, p. 66-71.

- Mirzayans, R., D. Severin, and D. Murray, 2006, Relationship between DNA double-strand break rejoining and cell survival after exposure to ionizing radiation in human fibroblast strains with differing ATM/p53 status: implications for evaluation of clinical radiosensitivity: *Int J Radiat Oncol Biol Phys*, v. 66, p. 1498-505.
- Moll, U. M., and O. Petrenko, 2003, The MDM2-p53 interaction: *Mol Cancer Res*, v. 1, p. 1001-8.
- Molyneux, G., F. C. Geyer, F. A. Magnay, A. McCarthy, H. Kendrick, R. Natrajan, A. Mackay, A. Grigoriadis, A. Tutt, A. Ashworth, J. S. Reis-Filho, and M. J. Smalley, 2010, BRCA1 basal-like breast cancers originate from luminal epithelial progenitors and not from basal stem cells: *Cell Stem Cell*, v. 7, p. 403-17.
- Moynahan, M. E., J. W. Chiu, B. H. Koller, and M. Jasin, 1999, Brca1 controls homology-directed DNA repair: *Mol Cell*, v. 4, p. 511-8.
- Moynahan, M. E., A. J. Pierce, and M. Jasin, 2001, BRCA2 is required for homology-directed repair of chromosomal breaks: *Mol Cell*, v. 7, p. 263-72.
- Narod, S. A., and W. D. Foulkes, 2004, BRCA1 and BRCA2: 1994 and beyond: *Nat Rev Cancer*, v. 4, p. 665-76.
- Narod, S. A., and K. Offit, 2005, Prevention and management of hereditary breast cancer.: *J Clin Oncol*, v. 23, p. 1656-63.
- Nigro, J. M., S. J. Baker, A. C. Preisinger, J. M. Jessup, R. Hostetter, K. Cleary, S. H. Bigner, N. Davidson, S. Baylin, and P. Devilee, 1989a, Mutations in the p53 gene occur in diverse human tumour types: *Nature*, v. 342, p. 705-8.
- Nigro, J. M., S. J. Baker, A. C. Preisinger, J. M. Jessup, R. Hostetter, K. Cleary, S. H. Bigner, N. Davidson, S. Baylin, and P. Devilee, 1989b, Mutations in the p53 gene occur in diverse human tumour types.: *Nature*, v. 342, p. 705-8.
- O'Sullivan, R. J., and J. Karlseder, 2010, Telomeres: protecting chromosomes against genome instability: *Nat Rev Mol Cell Biol*, v. 11, p. 171-81.
- Olivier, M., R. Eeles, M. Hollstein, M. A. Khan, C. C. Harris, and P. Hainaut, 2002, The IARC TP53 database: new online mutation analysis and recommendations to users.: *Hum Mutat*, v. 19, p. 607-14.
- Olivier, M., M. Hollstein, and P. Hainaut, 2010, TP53 mutations in human cancers: origins, consequences, and clinical use: *Cold Spring Harb Perspect Biol*, v. 2, p. a001008.
- Oren, M., 2003, Decision making by p53: life, death and cancer.: *Cell Death Differ*, v. 10, p. 431-42.
- Oren, M., and V. Rotter, 2010, Mutant p53 gain-of-function in cancer: *Cold Spring Harb Perspect Biol*, v. 2, p. a001107.
- Palacios, J., E. Honrado, A. Osorio, A. Cazorla, D. Sarrió, A. Barroso, S. Rodríguez, J. C. Cigudosa, O. Diez, C. Alonso, E. Lerma, J. Dopazo, C. Rivas, and J. Benítez, 2005, Phenotypic characterization of BRCA1 and BRCA2 tumors based in a tissue microarray study with 37 immunohistochemical markers: *Breast Cancer Res Treat*, v. 90, p. 5-14.
- Palacios, J., E. Honrado, A. Osorio, A. Cazorla, D. Sarrió, A. Barroso, S. Rodríguez, J. C. Cigudosa, O. Diez, C. Alonso, E. Lerma, L. Sánchez, C. Rivas, and J. Benítez, 2003, Immunohistochemical characteristics defined by tissue microarray of hereditary breast cancer not attributable to BRCA1

- or BRCA2 mutations: differences from breast carcinomas arising in BRCA1 and BRCA2 mutation carriers: *Clin Cancer Res*, v. 9, p. 3606-14.
- Palmero, E. I., L. Schüler-Faccini, M. Caleffi, M. I. Achatz, M. Olivier, G. Martel-Planche, V. Marcel, E. Aguiar, J. Giacomazzi, I. P. Ewald, R. Giugliani, P. Hainaut, and P. Ashton-Prolla, 2008, Detection of R337H, a germline TP53 mutation predisposing to multiple cancers, in asymptomatic women participating in a breast cancer screening program in Southern Brazil.: *Cancer Lett*, v. 261, p. 21-5.
- Paskulin, D. D., J. Giacomazzi, M. I. Achatz, S. Costa, R. M. Reis, P. Hainaut, S. E. dos Santos, and P. Ashton-Prolla, 2015, Ancestry of the Brazilian TP53 c.1010G>A (p.Arg337His, R337H) Founder Mutation: Clues from Haplotyping of Short Tandem Repeats on Chromosome 17p: *PLoS One*, v. 10, p. e0143262.
- Petitjean, A., E. Mathe, S. Kato, C. Ishioka, S. V. Tavtigian, P. Hainaut, and M. Olivier, 2007, Impact of mutant p53 functional properties on TP53 mutation patterns and tumor phenotype: lessons from recent developments in the IARC TP53 database: *Hum Mutat*, v. 28, p. 622-9.
- Rahman, N., S. Seal, D. Thompson, P. Kelly, A. Renwick, A. Elliott, S. Reid, K. Spanova, R. Barfoot, T. Chagtai, H. Jayatilake, L. McGuffog, S. Hanks, D. G. Evans, D. Eccles, D. F. Easton, M. R. Stratton, and B. C. S. C. (UK), 2007, PALB2, which encodes a BRCA2-interacting protein, is a breast cancer susceptibility gene: *Nat Genet*, v. 39, p. 165-7.
- Rebbeck, T. R., H. T. Lynch, S. L. Neuhausen, S. A. Narod, L. Van't Veer, J. E. Garber, G. Evans, C. Isaacs, M. B. Daly, E. Matloff, O. I. Olopade, B. L. Weber, and P. a. O. o. S. E. P. S. Group, 2002, Prophylactic oophorectomy in carriers of BRCA1 or BRCA2 mutations.: *N Engl J Med*, v. 346, p. 1616-22.
- Ribeiro, R. C., F. Sandrini, B. Figueiredo, G. P. Zambetti, E. Michalkiewicz, A. R. Lafferty, L. DeLacerda, M. Rabin, C. Cadwell, G. Sampaio, I. Cat, C. A. Stratakis, and R. Sandrini, 2001, An inherited p53 mutation that contributes in a tissue-specific manner to pediatric adrenal cortical carcinoma: *Proc Natl Acad Sci U S A*, v. 98, p. 9330-5.
- Rivlin, N., R. Brosh, M. Oren, and V. Rotter, 2011, Mutations in the p53 Tumor Suppressor Gene: Important Milestones at the Various Steps of Tumorigenesis: *Genes Cancer*, v. 2, p. 466-74.
- Roos, W. P., and B. Kaina, 2006, DNA damage-induced cell death by apoptosis: *Trends Mol Med*, v. 12, p. 440-50.
- Roy, R., J. Chun, and S. N. Powell, 2012, BRCA1 and BRCA2: different roles in a common pathway of genome protection: *Nat Rev Cancer*, v. 12, p. 68-78.
- Sablina, A. A., A. V. Budanov, G. V. Ilyinskaya, L. S. Agapova, J. E. Kravchenko, and P. M. Chumakov, 2005, The antioxidant function of the p53 tumor suppressor.: *Nat Med*, v. 11, p. 1306-13.
- Sandhu, S. K., W. R. Schelman, G. Wilding, V. Moreno, R. D. Baird, S. Miranda, L. Hylands, R. Riisnaes, M. Forster, A. Omlin, N. Kreischer, K. Thway, H. Gevensleben, L. Sun, J. Loughney, M. Chatterjee, C. Toniatti, C. L. Carpenter, R. Iannone, S. B. Kaye, J. S. de Bono, and R. M. Wenham, 2013, The poly(ADP-ribose) polymerase inhibitor niraparib (MK4827) in

- BRCA mutation carriers and patients with sporadic cancer: a phase 1 dose-escalation trial: *Lancet Oncol*, v. 14, p. 882-92.
- Sawyer, S. L., L. Tian, M. Kähkönen, J. Schwartzenuber, M. Kircher, J. Majewski, D. A. Dymant, A. M. Innes, K. M. Boycott, L. A. Moreau, J. S. Moilanen, R. A. Greenberg, U. o. W. C. f. M. Genomics, and F. C. Consortium, 2015, Biallelic mutations in BRCA1 cause a new Fanconi anemia subtype: *Cancer Discov*, v. 5, p. 135-42.
- Shamas-Din, A., H. Brahmhatt, B. Leber, and D. W. Andrews, 2011, BH3-only proteins: Orchestrators of apoptosis: *Biochim Biophys Acta*, v. 1813, p. 508-20.
- Shlien, A., U. Tabori, C. R. Marshall, M. Pienkowska, L. Feuk, A. Novokmet, S. Nanda, H. Druker, S. W. Scherer, and D. Malkin, 2008, Excessive genomic DNA copy number variation in the Li-Fraumeni cancer predisposition syndrome: *Proc Natl Acad Sci U S A*, v. 105, p. 11264-9.
- Siegel, R. L., K. D. Miller, and A. Jemal, 2015, Cancer statistics, 2015: *CA Cancer J Clin*, v. 65, p. 5-29.
- Struewing, J. P., P. Hartge, S. Wacholder, S. M. Baker, M. Berlin, M. McAdams, M. M. Timmerman, L. C. Brody, and M. A. Tucker, 1997, The risk of cancer associated with specific mutations of BRCA1 and BRCA2 among Ashkenazi Jews: *N Engl J Med*, v. 336, p. 1401-8.
- Tabori, U., S. Nanda, H. Druker, J. Lees, and D. Malkin, 2007, Younger age of cancer initiation is associated with shorter telomere length in Li-Fraumeni syndrome: *Cancer Res*, v. 67, p. 1415-8.
- Tai, Y. C., S. Domchek, G. Parmigiani, and S. Chen, 2007, Breast cancer risk among male BRCA1 and BRCA2 mutation carriers: *J Natl Cancer Inst*, v. 99, p. 1811-4.
- Tan, M., S. Li, M. Swaroop, K. Guan, L. W. Oberley, and Y. Sun, 1999, Transcriptional activation of the human glutathione peroxidase promoter by p53.: *J Biol Chem*, v. 274, p. 12061-6.
- Tavtigian, S. V., J. Simard, J. Rommens, F. Couch, D. Shattuck-Eidens, S. Neuhausen, S. Merajver, S. Thorlacius, K. Offit, D. Stoppa-Lyonnet, C. Belanger, R. Bell, S. Berry, R. Bogden, Q. Chen, T. Davis, M. Dumont, C. Frye, T. Hattier, S. Jammulapati, T. Janecki, P. Jiang, R. Kehrer, J. F. Leblanc, J. T. Mitchell, J. McArthur-Morrison, K. Nguyen, Y. Peng, C. Samson, M. Schroeder, S. C. Snyder, L. Steele, M. Stringfellow, C. Stroup, B. Swedlund, J. Swense, D. Teng, A. Thomas, T. Tran, M. Tranchant, J. Weaver-Feldhaus, A. K. Wong, H. Shizuya, J. E. Eyfjord, L. Cannon-Albright, F. Labrie, M. H. Skolnick, B. Weber, A. Kamb, and D. E. Goldgar, 1996, The complete BRCA2 gene and mutations in chromosome 13q-linked kindreds: *Nat Genet*, v. 12, p. 333-7.
- Thomas, M., D. Pim, and L. Banks, 1999, The role of the E6-p53 interaction in the molecular pathogenesis of HPV: *Oncogene*, v. 18, p. 7690-700.
- Thorlacius, S., S. Sigurdsson, H. Bjarnadottir, G. Olafsdottir, J. G. Jonasson, L. Tryggvadottir, H. Tulinius, and J. E. Eyfjord, 1997, Study of a single BRCA2 mutation with high carrier frequency in a small population: *Am J Hum Genet*, v. 60, p. 1079-84.

- Toledo, L. I., M. Murga, P. Gutierrez-Martinez, R. Soria, and O. Fernandez-Capetillo, 2008, ATR signaling can drive cells into senescence in the absence of DNA breaks: *Genes Dev*, v. 22, p. 297-302.
- Trkova, M., K. Prochazkova, V. Krutilkova, D. Sumerauer, and Z. Sedlacek, 2007, Telomere length in peripheral blood cells of germline TP53 mutation carriers is shorter than that of normal individuals of corresponding age.: *Cancer*, v. 110, p. 694-702.
- Tucker, T., and J. M. Friedman, 2002, Pathogenesis of hereditary tumors: beyond the "two-hit" hypothesis.: *Clin Genet*, v. 62, p. 345-57.
- Ventura, A., D. G. Kirsch, M. E. McLaughlin, D. A. Tuveson, J. Grimm, L. Lintault, J. Newman, E. E. Reczek, R. Weissleder, and T. Jacks, 2007, Restoration of p53 function leads to tumour regression in vivo: *Nature*, v. 445, p. 661-5.
- Vousden, K. H., and D. P. Lane, 2007, p53 in health and disease.: *Nat Rev Mol Cell Biol*, v. 8, p. 275-83.
- Walsh, C. S., 2015, Two decades beyond BRCA1/2: Homologous recombination, hereditary cancer risk and a target for ovarian cancer therapy: *Gynecol Oncol*, v. 137, p. 343-50.
- Wang, P. Y., W. Ma, J. Y. Park, F. S. Celi, R. Arena, J. W. Choi, Q. A. Ali, D. J. Tripodi, J. Zhuang, C. U. Lago, L. C. Strong, S. L. Talagala, R. S. Balaban, J. G. Kang, and P. M. Hwang, 2013, Increased oxidative metabolism in the Li-Fraumeni syndrome: *N Engl J Med*, v. 368, p. 1027-32.
- Weisz, L., M. Oren, and V. Rotter, 2007, Transcription regulation by mutant p53: *Oncogene*, v. 26, p. 2202-11.
- West, S. C., 2003, Molecular views of recombination proteins and their control: *Nat Rev Mol Cell Biol*, v. 4, p. 435-45.
- Wong, P., and K. Han, 2014, Lack of toxicity in a patient with germline TP53 mutation treated with radiotherapy: *Curr Oncol*, v. 21, p. e349-53.
- Wooster, R., G. Bignell, J. Lancaster, S. Swift, S. Seal, J. Mangion, N. Collins, S. Gregory, C. Gumbs, and G. Micklem, 1995, Identification of the breast cancer susceptibility gene BRCA2: *Nature*, v. 378, p. 789-92.
- Wooster, R., and B. L. Weber, 2003, Breast and ovarian cancer: *N Engl J Med*, v. 348, p. 2339-47.
- Wu, G. S., K. Kim, and W. S. el-Deiry, 2000, KILLER/DR5, a novel DNA-damage inducible death receptor gene, links the p53-tumor suppressor to caspase activation and apoptotic death: *Adv Exp Med Biol*, v. 465, p. 143-51.
- Xue, W., L. Zender, C. Miething, R. A. Dickins, E. Hernando, V. Krizhanovsky, C. Cordon-Cardo, and S. W. Lowe, 2007, Senescence and tumour clearance is triggered by p53 restoration in murine liver carcinomas: *Nature*, v. 445, p. 656-60.
- Yoon, K. A., Y. Nakamura, and H. Arakawa, 2004, Identification of ALDH4 as a p53-inducible gene and its protective role in cellular stresses.: *J Hum Genet*, v. 49, p. 134-40.
- Zhu, Q., M. A. Wani, M. El-Mahdy, and A. A. Wani, 2000, Decreased DNA repair efficiency by loss or disruption of p53 function preferentially affects removal of cyclobutane pyrimidine dimers from non-transcribed strand and slow repair sites in transcribed strand: *J Biol Chem*, v. 275, p. 11492-7.

- Produção científica complementar: artigos científicos publicados como co-autor durante o período de doutoramento.
- Aprovação dos projetos apresentados nesta tese no comitê de ética e pesquisa do Hospital de Clínicas de Porto Alegre.

Produção científica complementar (co-autorias de Gabriel S. Macedo, GS Macedo).

TP53 p.R337H is a conditional cancer-predisposing mutation: further evidence from a homozygous patient.

Giacomazzi J, Selistre S, Duarte J, Ribeiro JP, Vieira PJ, **de Souza Macedo G**, Rossi C, Czepielewski M, Netto CB, Hainaut P, Ashton-Prolla P. *BMC Cancer*. 2013 Apr 9;13:187. doi: 10.1186/1471-2407-13-187.

Are acinic cell carcinomas of the breast and salivary glands distinct diseases?

Piscuoglio S, Hodi Z, Katabi N, Guerini-Rocco E, **Macedo GS**, Ng CK, Edelweiss M, De Mattos-Arruda L, Wen HY, Rakha EA, Ellis IO, Rubin BP, Weigelt B, Reis-Filho JS. *Histopathology*. 2015 Oct;67(4):529-37.

miRNA-21 and miRNA-34a Are Potential Minimally Invasive Biomarkers for the Diagnosis of Pancreatic Ductal Adenocarcinoma.

Aleamar B, Izetti P, Gregório C, **Macedo GS**, Castro MA, Osvaldt AB, Matte U, Ashton-Prolla P. *Pancreas*. 2016 Jan;45(1):84-92.

Genetic Variations in the TP53 Pathway in Native Americans Strongly Suggest Adaptation to the High Altitudes of the Andes.

Jacovas VC, Rovaris DL, Pérez O, de Azevedo S, **Macedo GS**, Sandoval JR, Salazar-Granara A, Villena M, Dugoujon JM, Bisso-Machado R, Petzl-Erler ML, Salzano FM, Ashton-Prolla P, Ramallo V, Bortolini MC. *PLoS One*. 2015 Sep 18;10(9):e0137823.

Uterine adenosarcomas are mesenchymal neoplasms.

Piscuoglio S, Burke KA, Ng CK, Papanastasiou AD, Geyer FC, **Macedo GS**, Martelotto LG, de Bruijn I, De Filippo MR, Schultheis AM, Ioris RA, Levine DA, Soslow RA, Rubin BP, Reis-Filho JS, Weigelt B. *J Pathol*. 2016 Feb;238(3):381-8.

Massively Parallel Sequencing-Based Clonality Analysis of Synchronous Endometrioid Endometrial and Ovarian Carcinomas.

Schultheis AM, Ng CK, De Filippo MR, Piscuoglio S, **Macedo GS**, Gatus S, Perez Mies B, Soslow RA, Lim RS, Viale A, Huberman KH, Palacios JC, Reis-Filho JS, Matias-Guiu X, Weigelt B. *J Natl Cancer Inst*. 2016 Feb 1;108(6).

Massively parallel sequencing of phyllodes tumours of the breast reveals actionable mutations, and TERT promoter hotspot mutations and TERT gene amplification as likely drivers of progression.

Piscuoglio S, Ng CK, Murray M, Burke KA, Edelweiss M, Geyer FC, **Macedo GS**, Inagaki A, Papanastasiou AD, Martelotto LG, Marchio C, Lim RS, Ioris RA, Nahar PK, Bruijn ID, Smyth L, Akram M, Ross D, Petrini JH, Norton L, Solit DB, Baselga J, Brogi E, Ladanyi M, Weigelt B, Reis-Filho JS. *J Pathol*. 2016 Mar;238(4):508-18.

The Genomic Landscape of Male Breast Cancers.

Piscuoglio S, Ng CK, Murray MP, Guerini-Rocco E, Martelotto LG, Geyer FC, Bidard FC, Berman S, Fusco N, Sakr RA, Eberle C, De Mattos-Arruda L, **Macedo GS**, Akram M, Baslan T, Hicks J, King TA, Brogi E, Norton L, Weigelt B, Hudis CA, Reis-Filho JS. *Clin Cancer Res*. 2016 Mar 9.

HRAS and PIK3CA mutations underpin breast adenomyoepitheliomas promoting myoepithelial differentiation.

Huei-Chi Wen, Kathleen A Burke, Felipe C Geyer, Salvatore Piscougllo, Anastasios D Papanastatiou, Marcia Edelweiss, Anne M Schultheis, **Gabriel S Macedo**, Luciano G Martelotto, Maria R de Filippo, Zsuzsanna Varga, Emad A Rakha, Ian O Ellis, Brian P Rubin, Charlotte K Y Ng, Britta Weigelt and Jorge S Reis-Filho.

Submetido para o periódico *Genome Biology*, 2016.

Comparison of multiple genotyping methods for the identification of the cancer predisposing founder mutation p.R337H in TP53.

Fitarelli-Kiehl M, Macedo GS, Schlatter RP, Koehler-Santos P, Matte U, Ashton-Prolla P, Giacomazzi J. *Genetics and Molecular Biology* 2016.



HCPA - HOSPITAL DE CLÍNICAS DE PORTO ALEGRE
Grupo de Pesquisa e Pós-Graduação
COMISSÃO CIENTÍFICA E COMISSÃO DE PESQUISA E ÉTICA EM SAÚDE

A Comissão Científica e a Comissão de Pesquisa e Ética em Saúde, que é reconhecida pela Comissão Nacional de Ética em Pesquisa (CONEP)/MS como Comitê de Ética em Pesquisa do HCPA e pelo Office For Human Research Protections (OHRP)/USDHHS, como Institutional Review Board (IRB00000921) analisaram o projeto:

Projeto: 100405

Pesquisador Responsável:
PATRICIA ASHTON PROLLA

Título: Caracterização funcional da mutação TP53 p.R337H: Um estudo in vitro das vias celulares associadas à sinalização da proteína p53

EMENDA AO PROJETO **Data da Versão:**
08/05/2013

Este documento referente ao projeto acima foi **APROVADO** em seus aspectos éticos e metodológicos, de acordo com as Diretrizes e Normas Internacionais e Nacionais, especialmente as Resoluções 196/96 e complementares do Conselho Nacional de Saúde.

Porto Alegre, 28 de maio de 2013.

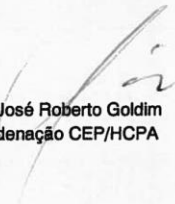
Prof. José Roberto Goldim
Coordenação CEP/HCPA



**HCPA - HOSPITAL DE CLÍNICAS DE PORTO ALEGRE
GRUPO DE PESQUISA E PÓS-GRADUAÇÃO**

COMISSÃO CIENTÍFICA

A Comissão Científica do Hospital de Clínicas de Porto Alegre analisou o projeto:

Projeto: 130529

Data da Versão do Projeto:

Pesquisadores:

PATRICIA ASHTON PROLLA

CRISTINA BRINCKMANN OLIVEIRA NETTO

JULIANA GIACOMAZZI

GABRIEL DE SOUZA MACEDO

CARMEN REGLA VARGAS

PATRICIA SANTOS DA SILVA

FILIPPO PINTO VAIRO

Título: Estudo exploratório do efeito da suplementação com substâncias antioxidantes sobre o fenótipo bioquímico de estresse oxidativo e inflamatório de pacientes portadores da mutação TP53 p.R337H.

Este projeto foi APROVADO em seus aspectos éticos, metodológicos, logísticos e financeiros para ser realizado no Hospital de Clínicas de Porto Alegre.

Esta aprovação está baseada nos pareceres dos respectivos Comitês de Ética e do Serviço de Gestão em Pesquisa.

- Os pesquisadores vinculados ao projeto não participaram de qualquer etapa do processo de avaliação de seus projetos.

- O pesquisador deverá apresentar relatórios semestrais de acompanhamento e relatório final ao Grupo de Pesquisa e Pós-Graduação (GPPG)

Porto Alegre, 24 de janeiro de 2014.

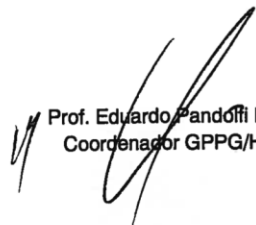
Prof. Eduardo Pandóffi Passos
Coordenador GPPG/HCPA

